

HDD & DVD Player/ Recorder

DVDR3450H
DVDR3452H
DVDR3460H
DVDR3465H

User Manual

Thank you for choosing Philips.

Need help fast?

Read your Quick Use/Start Guide and/or User Manual first for quick tips that make using your Philips product more enjoyable.

*If you have read your instructions and still need assistance, you may access our online help at **www.philips.com/support***



VIDEO *Plus+*[®]

SHOWVIEW[™]

PHILIPS

Important notes for users in the U.K. Mains plug

This apparatus is fitted with an approved 13 Amp plug. To change a fuse in this type of plug proceed as follows:

- 1 Remove fuse cover and fuse.
- 2 Fix new fuse which should be a BS1362 5 Amp, A.S.T.A. or BSI approved type.
- 3 Refit the fuse cover.

If the fitted plug is not suitable for your socket outlets, it should be cut off and an appropriate plug fitted in its place. If the mains plug contains a fuse, this should have a value of 5 Amp. If a plug without a fuse is used, the fuse at the distribution board should not be greater than 5 Amp.

Note: The severed plug must be disposed of to avoid a possible shock hazard should it be inserted into a 13 Amp socket elsewhere.

How to connect a plug

The wires in the mains lead are coloured with the following code: blue = neutral (N), brown = live (L).

- As these colours may not correspond with the colour markings identifying the terminals in your plug, proceed as follows:
 - Connect the blue wire to the terminal marked N or coloured black.
 - Connect the brown wire to the terminal marked L or coloured red.
 - Do not connect either wire to the earth terminal in the plug, marked E (or e) or coloured green (or green and yellow).

Before replacing the plug cover, make certain that the cord grip is clamped over the sheath of the lead - not simply over the two wires.

Copyright in the U.K.

Recording and playback of material may require consent. See Copyright Act 1956 and The Performer's Protection Acts 1958 to 1972.

DK

Advarsel: Usynlig laserstråling ved åbning når sikkerhedsafbrydere er ude af funktion. Undgå udsættelse for stråling.

Bemærk: Netafbryderen er sekundært indkoblet og afbryder ikke strømmen fra nettet. Den indbyggede netdel er derfor tilsluttet til lysnettet så længe netstikket sidder i stikkontakten.

S

Klass I laserapparat

Varning! Om apparaten används på annat sätt än i denna bruksanvisning specificerats, kan användaren utsättas för osynlig laserstråling, som överskrider gränsen för laserklass I.

Observera! Stömbrytaren är sekundärt kopplad och bryter inte strömmen från nätet. Den inbyggda nätdelen är därför ansluten till elnätet så länge stickproppen sitter i vägguttaget.

SF

Luokan I laserlaite

Varoitus! Laitteen käyttäminen muulla kuin tässä käyttöohjeessa mainitulla tavalla saattaa altistaa käyttäjän turvallisuusluokan I ylittävälle näkymättömälle lasersäteilylle. Oikeus muutoksiin varataan. Laite ei saa olla alttiina tippu-ja roiskevedelle.

Huom. Toiminnanvalitsin on kytketty toisiopuolelle, eikä se kytke laitetta irti sähköverkosta. Sisäänrakennettu verkko-osa on kytkettynä sähköverkkoon aina silloin, kun pistoke on pistorasiasa.

Italia

DICHIARAZIONE DI CONFORMITA'

Si dichiara che l'apparecchio DVDR3450H/
DVDR3452H/ DVDR3460H/ DVDR3465H,
Philips risponde alle prescrizioni dell'art. 2
comma 1 del D.M. 28 Agosto 1995 n. 548.

Fatto a Eindhoven

Philips Consumer Electronics
Philips, Glaslaan 2
5616 JB Eindhoven, The Netherlands

Norge

Typeskilt finnes på apparatens underside.

**Observer: Nettbryteren er sekundert
innkopleet. Den innebygde nettdelen er
derfor ikke frakopleet nettet så lenge
apparatet er tilsluttet nettkontakten.**

For å redusere faren for brann eller elektrisk
støt, skal apparatet ikke utsettes for regn eller
fuktighet.

CAUTION

VISIBLE AND INVISIBLE LASER
RADIATION WHEN OPEN.
AVOID EXPOSURE TO BEAM

ADVARSEL

SYNLIG OG USYNLIG LASERSTRÅLING
VED ÅBNING UNDGÅ UDSÆTTELSE FOR
STRÅLING

VARNING

SYNLIG OCH OSYNLIG
LASERSTRÅLNING NÄR DENNA DEL ÄR
ÖPPNAD BETRakta EJ STRÅLEN

VARO!

AVATTAESSA OLET ALTTIINA
NÄKYVÄLLE JA NÄKYMÄTTÖMÄLLE
LASER SÄTEILYLLE. ÄLÄ KATSO
SÄTEESEEN

VORSICHT

SICHTBARE UND UNSICHTBARE
LASERSTRAHLUNG WENN ABDECKUNG
GEÖFFNET NICHT DEM STRAHL
AUSSETZEN

ATTENTION

RAYONNEMENT LASER VISIBLE ET
INVISIBLE EN CAS D'OUVERTURE
EXPOSITION DANGEREUSE AU
FAISCEAU

For Customer Use:

Read carefully the information located at the
bottom or rear of your DVD recorder and
enter below the Serial No. Retain this
information for future reference.

Model No. DVDR3450H/ DVDR3452H/
DVDR3460H/ DVDR3465H

Serial No. _____

Disposal of your old product



Your product is designed and manufactured with high quality materials
and components, which can be recycled and reused.

When this crossed-out wheeled bin symbol is attached to a product it
means the product is covered by the European Directive 2002/96/EC.

Please inform yourself about the local separate collection system for
electrical and electronic products.

Please act according to your local rules and do not dispose of your old products with
your normal household waste. The correct disposal of your old product will help
prevent potential negative consequences for the environment and human health.

Due to the inconsistency of disc formats provided by various disc manufacturers, your DVD system/ player/recorder may require a playability enhancement or upgrade. As DVD technology advances, these enhancement will become common and will be easy to complete. Go to www.philips.com/support for software upgrade.

En raison de la diversité des formats utilisés par les fabricants, votre système DVD peut nécessiter l'ajout de périphériques ou une mise à niveau logicielle. Au fur et à mesure des progrès de la technologie DVD, ces périphériques se font de plus en plus courants et aisés à intégrer. Pour télécharger la mise à niveau logicielle, visitez le site www.philips.com/support.

Debido a los diferentes formatos de discos disponibles en el mercado, es posible que deba realizar mejoras o actualizaciones en el sistema de DVD relativas a las funciones de reproducción. Conforme la tecnología DVD avanza, estas mejoras estarán al alcance de todo tipo de usuarios y se podrán llevar a cabo fácilmente. Visite la página "www.philips.com/support" para buscar información sobre actualizaciones de software.

Da das Disk-Format je nach Hersteller verschieden ist, ist für Ihr DVD-System möglicherweise die Erweiterung der Spielbarkeit oder eine Aktualisierung erforderlich. Da die DVD-Technologie sich ständig weiterentwickelt, werden sich diese Erweiterungen durchsetzen und einfach auszuführen sein. Gehen Sie zu für Ihre Software-Aktualisierung zu „www.philips.com/support“.

Doordat fabrikanten verschillende schijfindelingen aanbieden, moet uw dvd-systeem mogelijk worden geüpgraded of uitgebreid. Naarmate de dvd-technologie zich verder ontwikkelt, zullen deze uitbreidingen normaal worden en zult u ze gemakkelijk kunnen uitvoeren. Ga naar "www.philips.com/support" om uw software te upgraden.

A causa della differenza di formato tra i dischi forniti dai vari produttori, il sistema DVD potrebbe richiedere un potenziamento o aggiornamento della riproducibilità. Col progredire della tecnologia DVD, questi potenziamenti diverranno comuni e facili da implementare. Visitare "www.philips.com/support" per scaricare gli aggiornamenti del software.

På grund av de skillnader i skivformat som finns mellan olika skivleverantörer måste dvd-spelaren eventuellt förbättras eller upgraderas. I takt med att dvd-tekniken förbättras kommer de här förbättringarna att bli vanligare och enklare att slutföra. Om du vill utföra en programvaruuppdatering går du till "www.philips.com/support".

På grund af uoverensstemmelser mellem diskformater fra de forskellige diskproducenter, kan dit dvd-system kræve en afspilningsudvidelse eller en opgradering. Efterhånden som dvd-teknologien udvikles, vil disse udvidelser blive almindelige og vil være nemme at implementere. Gå til "www.philips.com/support", hvis du ønsker softwareopgradering.

Koska eri levyvalmistajat käyttävät erilaisia levyformaatteja, DVD-järjestelmäsi toimintoja täytyy ehkä laajentaa tai päivittää. DVD-teknikan kehittyessä nämä laajennukset yleistyvät ja ovat helposti toteutettavissa. Löydät ohjelmistopäivityksen sivustosta "www.philips.com/support".

Devido à inconsistência dos formatos de disco disponibilizados por vários fabricantes de discos, a capacidade de reprodução do seu sistema de DVD pode necessitar de ser melhorada ou atualizada. À medida que a tecnologia do DVD avança, estes melhoramentos tornam-se comuns e fáceis de completar. Visite "www.philips.com/support" para obter atualizações de software.

Λόγω της ασυνέπιας στην διαμόρφωση των δίσκων που παρέχονται από διάφορους κατασκευαστές δίσκων, το σύστημα DVD που χρησιμοποιείι νδέχεται να απαιτεί βελτίωση ή αναβάθμιση της δυνατότητας αναπαραγωγής. Καθώς εξίσεται η τεχνολογία των DVD, οι βελτίωσις αυτές θα ίναι συνηθισμένς και θα ίναι ύκολο να ολοκληρωθούν. Μταβίτ στη διύθυνηση "www.philips.com/support" για αναβάθμιση λογισμικού.

Ze względu na niekompatybilność formatów płyt oferowanych przez rozmaitych producentów, Twój system DVD może wymagać rozbudowy lub aktualizacji oprogramowania. W miarę zaawansowania technologii DVD możliwości tego rodzaju rozbudowy staną się powszechne i proste w realizacji. Odwiedź stronę "www.philips.com/support" aby pobrać aktualizację oprogramowania.

Из-за несовместимости форматов дисков различных производителей для вашей системы DVD может быть необходимо произвести обновлени или улучшить воспроизводимости. С развитием тхнологии DVD эти улучшения станут широкопользуемыми и просто выполняемыми. Обновлени программного обспания находится на вб-сайт "www.philips.com/support".

This product incorporates copyright protection technology that is protected by US patents. Use of this copyright protection technology must be authorised by Macrovision, and is intended for home and other limited viewing uses only unless otherwise authorised by Macrovision. Reverse engineering or disassembly is prohibited.

U.S. Patent Number 4,631,603; 4,819,098; 4,907,093; 5,315,448; and 6,516,132



Manufactured under license from Dolby Laboratories. "Dolby" and the double-D symbol are trademarks of Dolby Laboratories.



DivX®, DivX Certified, and associated logos are trademarks of DivX, Inc and are used under license.

SHOWVIEW™

SHOWVIEW® is a registered trademark of Gemstar Development Corporation. The SHOWVIEW® system is manufactured under license from Gemstar Development Corporation.



Video Plus+® and PlusCode are registered trademarks of Gemstar Development Corporation. The Video Plus+® system is manufactured under license from Gemstar Development Corporation.

This product complies with the radio interference requirements of the European Community.



This product complies with the requirements of the following directives and guidelines: 73/23/EEC + 89/336/EEC + 93/68/EEC

LASER

Type	Semiconductor laser InGaAlP (DVD) AlGaAs (CD)
Wave length	658 nm (DVD) 790 nm (CD)
Output Power	30 mW (DVD+RW write) 1.0 mW (DVD read) 1.0 mW (CD read)
Beam divergence	84 degrees (DVD) 61 degrees (CD)

Table of Contents

General

Care and Safety Information	8
Setup precautions.....	8
Cleaning discs	8
HDD (Hard Disk Drive) handling care.....	8
Product Information	9
Introduction.....	9
Accessories supplied	9
Region codes.....	9
Copyright notice.....	9
Special Features.....	10

Product Overview

Main Unit	11
Remote Control	12
Using the remote control	14

Connections

Step 1: Basic Recorder Connections.....	15
Connecting the antenna cables	15
Connecting the video cable.....	16
Connecting the audio cables.....	17
Step 2: Optional Connections.....	18
Connecting to a Cable Box or Satellite Receiver	18
Connecting to a VCR or other similar device.....	19
Connecting to a VCR and Cable Box/Satellite Receiver.....	20
Connecting a camcorder.....	21
Connecting a USB flash drive or USB memory card reader.....	22
Step 3: Installation and Setup.....	23
Finding the viewing channel.....	23
Setting the OSD language.....	23
Select the country of your residence	24
Setting your TV channel programmes.....	24
Setting the date & time.....	25

Watching TV

Control TV programmes.....	26
Switching on to TV programme.....	26
Pause live TV function.....	26
Instant Replay function	26

Recording

Before Recording	27
About temporary HDD storage (Time Shift Buffer)	27
Default Recording settings	28
GENERAL settings	29
Record on Hard Disk.....	30
Recording from various sources	30
Instant recording	32
Watch playback from another source during recording.....	33
Record on Recordable DVD	34
Copying from HDD to a recordable DVD.....	34
Discs for recording.....	34
Recording from various sources	35

Table of Contents

Timer Recording	37
About timer recording.....	37
Timer recording (SHOWVIEW® / VIDEO Plus+ System).....	37
Timer recording (manually).....	39
Changing/ Deleting a timer recording.....	40

Playback

Playback from Hard Disk	41
Playback your HDD recordings.....	41
Playback from Disc	42
Playable discs	42
Starting disc playback.....	42
Playback from USB	46
Playing from a USB flash drive/ USB memory card reader.....	46
Additional Playback Features	47
Changing to another title/chapter/track.....	47
Pausing playback and resume play.....	47
Searching forward/backward.....	47
Zooming in	47
Using DISPLAY options.....	48

Edit Recordings

Edit Recordings - HDD	51
About HDD title edit menu.....	51
Accessing the HDD title edit menu	51
Edit Recordings - Recordable DVD	54
About disc editing menu.....	54
Accessing disc editing menu	54
Playing your recordings on other DVD players (DVD±R only).....	56
About DVD title editing.....	57
Accessing DVD title edit menu.....	57
About video editing.....	59
Accessing video editing menu.....	59

Other Information

Setup Menu Options	62
Accessing the Setup Menu	62
SETUP settings.....	63
DATE/ TIME settings.....	65
GENERAL settings	66
AUDIO settings.....	67
LANGUAGE settings.....	67
PREFERENCES settings.....	68
HDD settings	69
Software Upgrade	70
Installing the latest software.....	70
Frequently Asked Questions	71
Troubleshooting	72
Specifications	76
Glossary	77
Display panel symbols /messages	78
TV System Guide	80

Care and Safety Information

CAUTION!

High voltage! Do not open the device. You run the risk of getting an electric shock.

The machine does not contain any user-serviceable parts. Please leave all maintenance work to qualified personnel.

Setup precautions

Finding a suitable location

- Place the set on a flat, hard and stable surface. Do not place the set on a carpet.
- Do not position the set on top of other equipment that might heat it up (e.g., receiver or amplifier).
- Do not put anything under the set (e.g., CDs, magazines).
- Install this unit near the AC outlet and where the AC power plug can be reached easily.

Space for ventilation

- Place the apparatus in a location with adequate ventilation to prevent internal heat build up. Allow at least 10 cm (4") clearance from the rear and the top of the set and 5 cm (2") from the left and right to prevent overheating.

Avoid high temperatures, moisture, water and dust

- Apparatus must not be exposed to dripping or splashing.
- Do not place any sources of danger on the apparatus (e.g., liquid filled objects, lighted candles).

Cleaning discs

Some problems occur because the disc inside the recorder is dirty (frozen picture, sound disruptions, picture distortions). To avoid these problems, discs should be cleaned on a regular basis.

To clean a disc, use a micro fibre cleaning cloth and wipe the disc from the centre to the edge in a straight line.

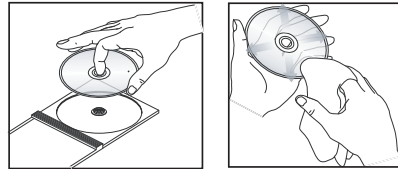

CAUTION!

Do not use solvents such as benzene, thinner, commercially available cleaners, or anti-static sprays intended for discs.

HDD (Hard Disk Drive) handling care

The hard disk drive (HDD) has a high storage density that enables long recording duration and high speed data access. Depending on the setup environment and handling, some content may be damaged resulting in failure of playback and recording. To avoid damage to the HDD and losing important data, observe following precautions:

- Do not move the recorder or subject it to vibration.
- Do not remove the AC power plug from the mains socket without switching the recorder to standby mode.

WARNING!

The HDD is not a device for storing recorded content permanently. We recommend that you copy important video content to a recordable DVD as backup.

Product Information

Introduction

This HDD and DVD recorder allows you the flexibility of keeping recordings in the HDD or archiving to a recordable DVD for future playback.

Model No.	HDD Size	USB Playback
DVDR3450H	160GB	No
DVDR3452H*		
DVDR3460H	250GB	Yes
DVDR3465H*		

*These models are in black finish.

Furthermore, you can take advantage of features like 'Instant Replay', or 'Pause Live TV'; see the section "Control TV programmes".

Before you can start using this recorder, you must complete the basic connections and set-up in three easy steps.

Step 1: Basic recorder connections

Step 2: Optional connections for other devices

Step 3: Basic installation and set-up

Please take time to read this user manual before using the recorder. It contains important information and notes regarding operations of the recorder.

Helpful Hints:

- If you have any questions or if problems occur during operation, see the chapter 'Troubleshooting'.
- If you need further assistance, please call the customer support service for your country. The corresponding telephone numbers and e-mail addresses are given in the guarantee booklet.
- Refer to the type plate on the rear or bottom of the product for identification and supply ratings.

Accessories supplied

- Remote control and batteries
- SCART cable
- RF coaxial cable
- Quick Start Guide

Region codes

DVD films are usually not released at the same time in all regions of the world, thus all DVD players are keyed to a specific region code.

This device will only play **Region 2** DVDs or DVDs manufactured to be played in all regions ('ALL'). DVDs from other regions cannot be played on this recorder.



Copyright notice

The making of unauthorised copies of copy-protected material, including computer programmes, files, broadcasts and sound recordings, may be an infringement of copyrights and constitute a criminal offence. This equipment should not be used for such purposes.

Product Information (continued)

Special Features

'Time Shift Buffer'

Once you switch on this recorder, the programme shown on the TV will be stored into the 'Time Shift Buffer'. It acts as a temporary storage of your recordings. The contents will automatically be deleted after 6 hours, when you turn off this recorder or when you switch it to standby mode. To store the contents on the hard disk, you have to mark the segment in the 'Time Shift Buffer' for recording to prevent them from being deleted.

'Instant Replay'

You can repeat the scene of a live TV programme by pressing the ◀ key on the remote control, as often as you like.

To return to the live TV programme, press and hold ▶.

'Pause Live TV'

A live TV programme is now under your control. You can pause the programme by pressing **PAUSE LIVE TV ▶||** key. Resume playback at the scene it was interrupted by pressing the **PAUSE LIVE TV ▶||** key.

To return to the live TV programme, press and hold ▶.

'Direct Recording to DVD'

This feature enables you to record content directly on to a recordable DVD.

Press the **DVD REC** key on the remote control to activate direct recording to the recordable DVD.

SHOWVIEW[®] VIDEO*Plus*⁷

This is a simple programming system for recorders. To use it, enter the programming number associated with your television programme. You can find this number in your favourite listings magazine.



Philips DVD recorders support 'dual media' recording – the ability to create recordings on + and – discs : DVD+R/+RW, DVD–R/–RW discs.



i.Link is also known as 'FireWire' and 'IEEE1394'. This connection is used for the transfer of high bandwidth digital signals as used by digital video (DV) camcorders. It carries both audio and video signals via a single cable.

Main Unit

English

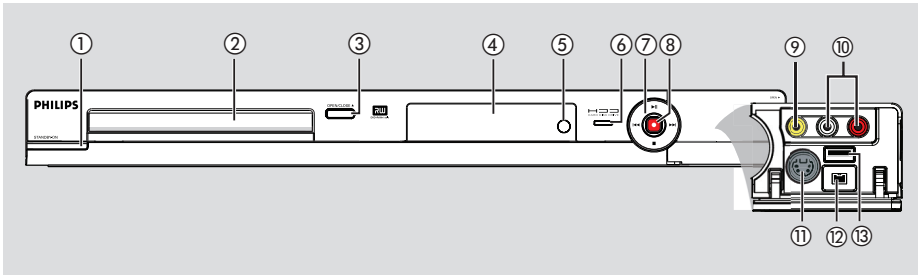

① STANDBY-ON

- Switches on the recorder or switches to standby mode.

② Disc tray

③ OPEN/CLOSE ▲

- Opens/closes the disc tray.

④ Display panel

- Show information about the current status of the recorder.

⑤ IR

- Point the remote control towards this sensor.

⑥ HDD Active indicator

- Blue indicator lights up while temporary recording to the time shift buffer is in progress.

⑦ ►||

- Starts playback of the selected title/track.
- Pauses playback of the selected title/track.

◀◀ / ▶▶

- Skips to the previous or next chapter/track, or hold down the key to make a reverse/forward search.

■

- Stops playback/recording.

⑧ ●

- Starts recording the current TV channel or the current video input source.
- Red indicator lights up while recording to the HDD or a recordable DVD disc is in progress.

Sockets behind the flap

Flip down the door as indicated by the **OPEN ►** label on the right hand corner.

⑨ CAM1 (VIDEO)

- Video input for camcorders or video recorders.
- In tuner mode, press **SOURCE** on the remote control repeatedly to select 'CAM1' when using this input source.

⑩ L/R AUDIO

- Audio input for camcorder or the audio/video device which is connected to the CAM1 or CAM2 socket.

⑪ CAM2 (S-VIDEO)

- S-video input for SVHS/Hi8 camcorders or SVHS/Hi8 video recorders.
- In tuner mode, press **SOURCE** on the remote control repeatedly to select 'CAM2' when using this input source.

⑫ DV IN

- Input for digital camcorders or other suitable devices using this connector.
- Press **USB/DV** on the remote control when using this input source.

⑬ USB (for DVDR3460H/ DVDR3465H)

- Input for USB flash drive / USB memory card reader.
- Press **USB/DV** on the remote control when using this input source.

Remote Control

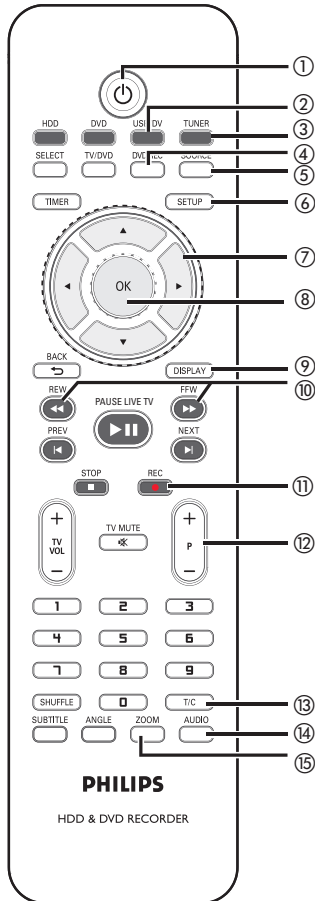

- ① **STANDBY-ON**
- Switches on the recorder or switches to standby mode.
- ② **USB/DV**
- Switches to 'camera mode' for camcorder connecting to DV IN socket. Recording can be made directly onto the HDD/DVD.
- (for DVDR3460H/ DVDR3465H)
- Press repeatedly to toggle between USB and DV modes.
 - Access the contents of the connected USB flash drive / USB memory card reader connected to USB socket.

- ③ **TUNER**
- Switches to the recorder's tuner mode (TV channel).
- ④ **DVD REC**
- Activates the 'direct recording to DVD' mode.
- ⑤ **SOURCE**
- In tuner or DVD REC mode, selects the recorder's video input source from the TV channel or external sources. (EXT1, EXT2, CAM1, CAM2).
- ⑥ **SETUP**
- Enters/exits the system setup menu.
- ⑦
- Cursor keys for moving to the left/ right or making a forward/reverse search.
 - In time shift mode, use key to jump forward 30 seconds and key to jump backward by 10 seconds.
 -
 - Cursor keys for moving up/down.
- ⑧ **OK**
- Stores/confirms an entry/selection.
- ⑨ **DISPLAY**
- Displays the Time Shift video bar.
 - Displays the on-screen help text.
- ⑩ **REW / FFW**
- Start fast backward/ forward search, press the key again to increase the search speed.
- ⑪ **REC**
- Starts recording the current TV channel or the current video input source.
- ⑫ **P /**
- While in tuner mode, selects the next/ previous TV channel program.
- ⑬ **T/C**
- Displays title/chapter information.
- ⑭ **AUDIO**
- In tuner mode, toggles between stereo, mono and the Secondary Audio Program modes.
- ⑮ **ZOOM**
- Enlarges a picture on the TV screen.

Remote Control (continued)

English

- ⑩ **DVD**
 - Switches to disc mode or displays the disc content menu.
- ⑪ **HDD**
 - Enters the HDD content menu.
- ⑫ **TV/DVD**
 - Switch between playback from the additional devices (connected via the EXT2 scart socket) and playback from the DVD recorder.
- ⑬ **SELECT**
 - Selects a track/chapter/file in the programme menu.
 - In HDD title menu, marks titles for copying to a recordable DVD.
- ⑭ **TIMER**
 - Enters/exits the timer recording menu.
- ⑮ **BACK** ⏪
 - Returns to the previous menu of a video CD (VCD) or some DVDs.
- ⑯ **PAUSE LIVE TV** ⏸
 - Plays a disc or recording.
 - Pauses playback.
 - Pauses 'Live TV' viewing.
- ⑰ **PREV** ⏪ / **NEXT** ⏩
 - Skips to previous or next chapter/track.
- ⑱ **STOP** ■
 - Stops playback/recording.
 - Press and hold the key to open and close the disc tray.
- ⑲ **TV VOL** + / –
 - Adjust the volume of the TV set (Philips TV only).
- ⑳ **TV MUTE** 🔇
 - Mute the volume of the TV set (Philips TV only).
- ㉑ **Numeric keypad**
 - Selects a chapter/track number to play.
 - Selects the recorder's preset TV tuner channel.

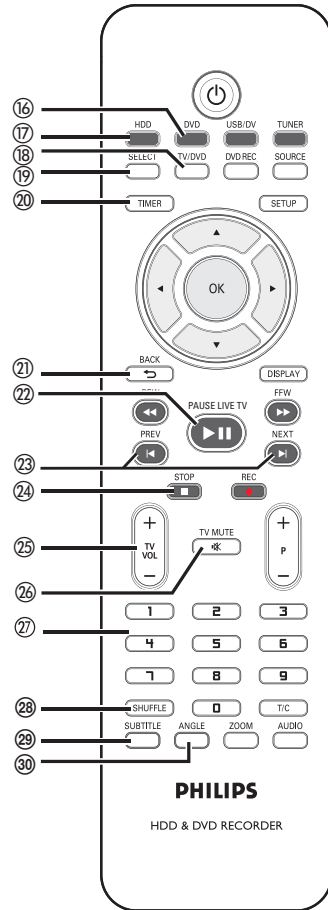

- ⑲ **SHUFFLE**
 - Switches to random playback of an audio CD, Video CD (VCD), picture CD or DVD disc.
 - In HDD title menu, select to sort the titles.
- ⑳ **SUBTITLE**
 - Selects a DVD subtitle language.
- ㉑ **ANGLE**
 - Selects a DVD disc camera angle (if available).

Remote Control (continued)

Using the remote control

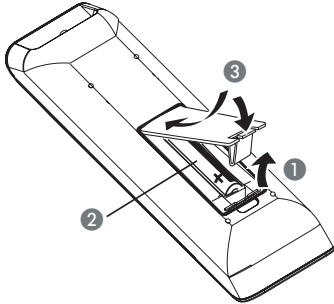

- 1 Open the battery compartment.
- 2 Insert two batteries of type R03 or AAA, following the indications (+ -) inside the compartment.
- 3 Close the cover.

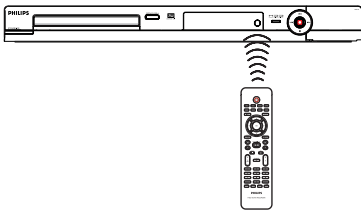

- 4 Aim the remote control directly at the remote sensor (IR) on the front panel.
- 5 Select the source you want to control by pressing the TUNER, HDD, DVD or USB/DV key on the remote control.
- 6 Select the desired function (for example ◀, ▶).

CAUTION!

- Remove batteries if they are exhausted or if the remote control will not be used for a long time.
- Do not mix batteries (old and new or carbon and alkaline, etc).
- Batteries contain chemical substances and should be disposed of properly.

Step 1: Basic Recorder Connections

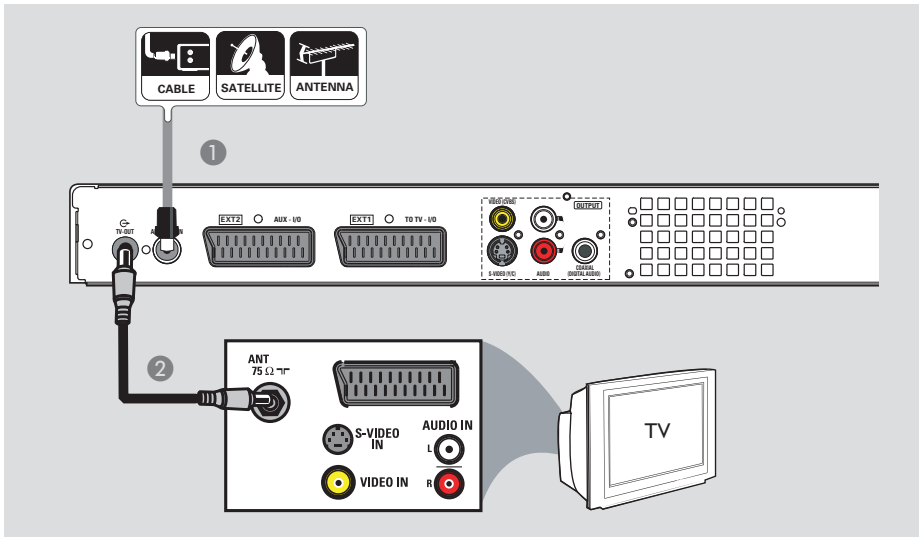

Connecting the antenna cables

These connections enable you to watch and record TV programmes using this recorder. If the antenna signal is connected via a VCR, Cable Box or Satellite Receiver, ensure that these devices are turned on in order to watch or record the cable programmes.

- **If you want to connect to a VCR and/or Cable Box/Satellite Receiver,** see the chapter “Step 2 : Optional Connections” for the possible connections to your TV.

- 1 Connect the existing Antenna/Cable TV signal (or from the Cable Box/Satellite Receiver {RF OUT or TO TV}) to the **ANTENNA-IN** socket on the recorder.
- 2 Use the supplied RF coaxial cable to connect the **TV-OUT** socket on the recorder to the antenna input socket (or labelled as VHF/UHF RF IN) on your TV.

Helpful Hint:

– Depending on how you have currently connected your TV (directly from an off-air antenna or Cable box or VCR), you will have to disconnect some of the cables before you make the above connection.

TIPS: Before making or changing any connections, make sure that all the devices are disconnected from the power outlet.

Step I: Basic Recorder Connections (continued)

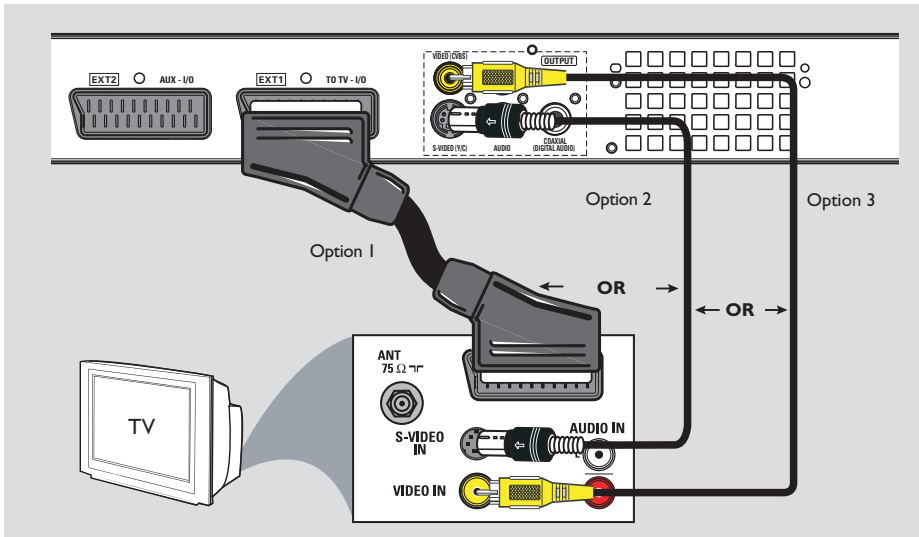

Connecting the video cable

This connection enables you to view the disc playback from the recorder. You only need to choose one of the options below to make your video connection.

Option 1: Using a SCART cable

- Use the SCART cable to connect the **EXT1 TO TV-I/O** scart socket on the recorder to the corresponding SCART input socket on the TV.

Helpful Hints:

- If your TV set displays a selection for the SCART socket, select 'VCR' as the source for the SCART socket.
- The EXT2 AUX-I/O scart socket is intended only for additional devices.

Option 2: Using an S-Video cable

- Use an S-video cable (not supplied) to connect the **S-VIDEO (Y/C)** socket on the recorder to the S-Video input socket (or labelled as Y/C or S-VHS) on the TV.
→ Audio connection is required in order to hear the sound, see next section "Connecting the audio cables".

Option 3: Using a Video (CVBS) cable

- Use a composite video cable (yellow - not supplied) to connect the **VIDEO (CVBS)** socket on the recorder to the video input socket (or labelled as A/V In, Video In, Composite or Baseband) on the TV.
→ Audio connection is required in order to hear the sound, see next section "Connecting the audio cables".

TIPS: Before making or changing any connections, make sure that all the devices are disconnected from the power outlet.

Step I: Basic Recorder Connections (continued)

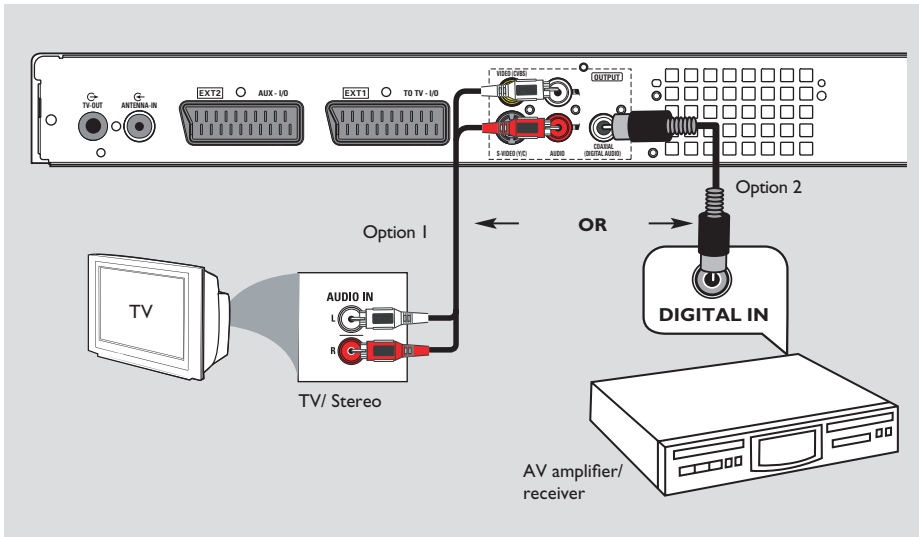

English

Connecting the audio cables

This connection enables you to listen to the sound. However, this connection is not required if this recorder is connected to the TV using the supplied SCART cable.

Option 1: Using an audio cable

You can connect the recorder to a two channel stereo system (mini system, TV) or receiver in order to enjoy the stereo sound system.

- Use the supplied audio cable (red/white ends) to connect the **AUDIO L/R** sockets to these devices with the same input sockets.

Option 2: Using a coaxial cable

You can connect the recorder to an AV amplifier/receiver in order to enjoy multichannel surround sound.

- Use a coaxial cable (not supplied). Connect the **COAXIAL (DIGITAL AUDIO)** socket on the recorder to the digital input of the amplifier/receiver.

Before you start operating, set the digital audio output settings accordingly (see the section "PLAYBACK settings – Digital Audio Output"). If the AUDIO settings do not match your amplifier's capabilities, the amplifier may produce a strong, distorted sound or no sound at all.

Helpful Hint:

– Do not connect your TV's audio output sockets to the AUDIO L/R (IN-EXT) sockets on this recorder, this may cause unwanted noise.

TIPS: Before making or changing any connections, make sure that all the devices are disconnected from the power outlet.

Step 2: Optional Connections

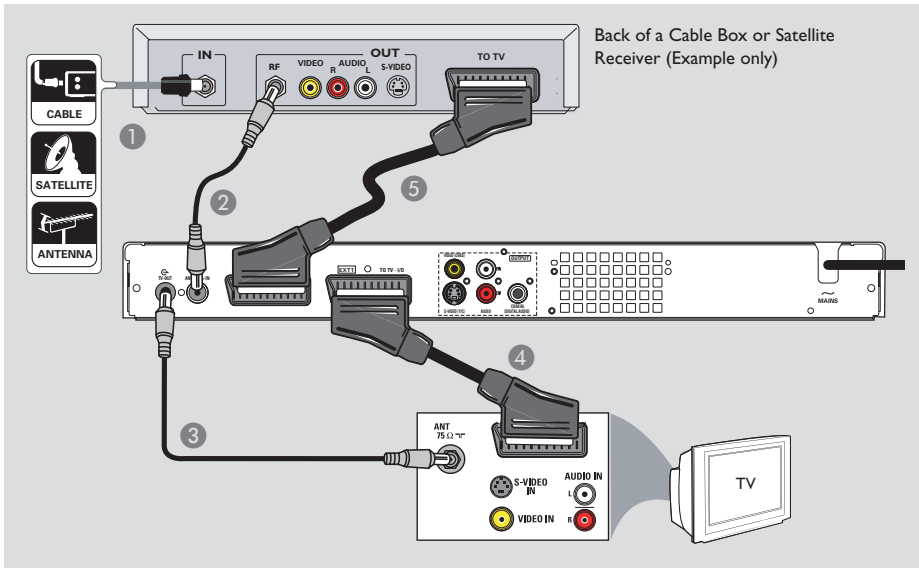

Back of a Cable Box or Satellite Receiver (Example only)

Connecting to a Cable Box or Satellite Receiver

Option 1

If your Cable Box/Satellite Receiver has only an antenna output socket (RF OUT or TO TV),

see "Step 1: Basic Recorder Connections – Connecting the antenna cables" for the complete connections to your TV.

Option 2 (as shown on the above illustration) If your Cable Box/Satellite Receiver has a SCART output socket

- 1 Keep the existing antenna connection to your Cable Box/Satellite Receiver.
- 2 Use a RF coaxial cable to connect the Cable Box/Satellite Receiver signal (or labelled as RF OUT or TO TV) to the **ANTENNA-IN** socket on the recorder.
- 3 Use another RF coaxial cable to connect the **TV-OUT** socket on the recorder to the antenna input socket on the TV.
- 4 Use the SCART cable to connect the **EXT1 TO TV-I/O** scart socket on the recorder to the corresponding SCART input socket on the TV.
- 5 Use another SCART cable to connect the **EXT2 AUX-I/O** scart socket on the recorder to the SCART output socket (or labelled as TV OUT or TO TV) on the Cable Box/ Satellite Receiver.

TIPS: Refer to the respective connected device's user manual for other possible connections.

Step 2: Optional Connections (continued)

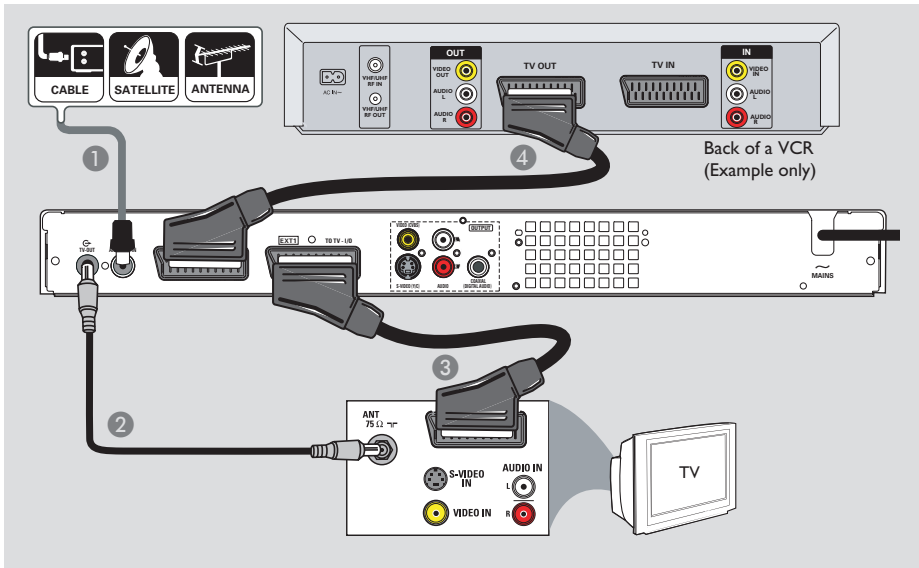

English

Connecting to a VCR or other similar device

This connection enables you to record from a video tape to the HDD or a recordable DVD and allows the VCR to be used for playback if the recorder is turned off.

IMPORTANT!

Your new recorder can replace the VCR for all your recording needs. Just unplug all the connections to your VCR.

- 1 Connect the existing Antenna/Satellite/Cable TV signal (or from the Cable Box/Satellite Receiver, labelled as RF OUT or TO TV) to the **ANTENNA-IN** socket on the recorder.

- 2 Use another RF coaxial cable to connect the **TV-OUT** socket on the recorder to the antenna input socket on the TV.
- 3 Use the SCART cable to connect the **EXT1 TO TV-I/O** scart socket on the recorder to the corresponding SCART input socket on the TV.
- 4 Use another SCART cable to connect the **EXT2 AUX-I/O** scart socket on the recorder to the SCART output socket (or labelled as TV OUT or TO TV) on the VCR.

Helpful Hints:

- Most commercial video cassettes and DVDs are copy-protected and therefore cannot be recorded.
- Connect the recorder directly to the TV. If there is a VCR or an additional device in between, the picture quality may be poor because of the copy protection system built into the recorder.

TIPS: Refer to the respective connected device's user manual for other possible connections.

Step 2: Optional Connections (continued)

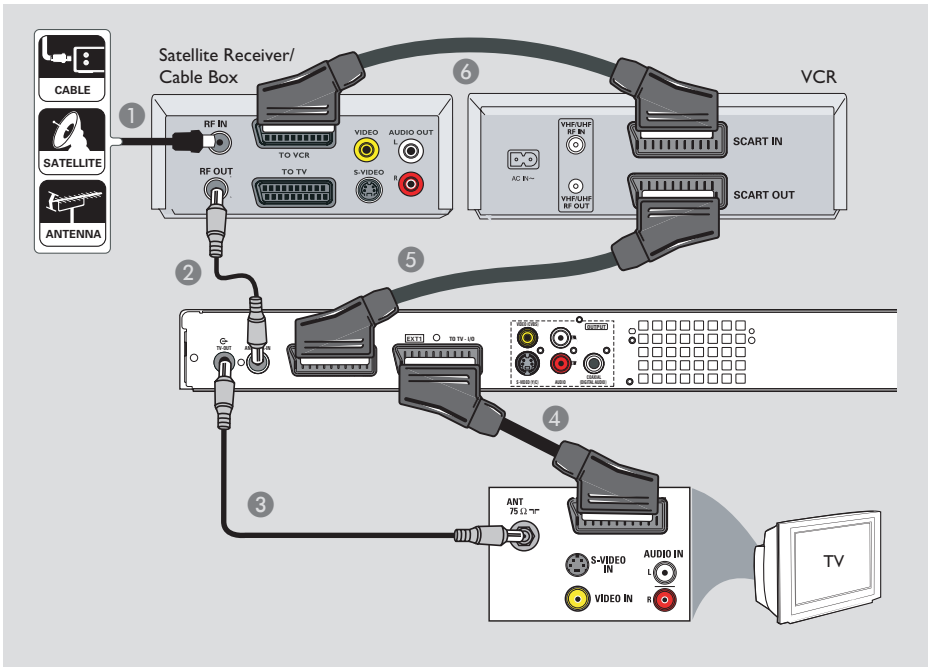

Connecting to a VCR and Cable Box/Satellite Receiver

- 1 Keep the existing aerial connection from the Cable Box/Satellite Receiver to your TV.
- 2 Use the supplied RF coaxial cable to connect the antenna output (RF OUT) socket on the Cable Box/Satellite Receiver to the **ANTENNA-IN** socket on the recorder.
- 3 Use another RF coaxial cable to connect the **TV-OUT** socket on the recorder to the antenna input socket on the TV.
- 4 Use the SCART cable to connect the **EXT1 TO TV-I/O** scart socket on the recorder to the corresponding SCART input socket on the TV.
- 5 Use another SCART cable to connect the **EXT2 AUX-I/O** scart socket on the recorder to the Scart output socket (or labelled as TV OUT or TO TV) on the VCR.
- 6 Use another scart cable to connect the scart input socket (or labelled as TV IN or TO DECODER) on the VCR to the scart output socket (or labelled as TV OUT or TO VCR) on the Cable Box/Satellite Receiver.

TIPS: Refer to the respective connected device's user manual for other possible connections.

Step 2: Optional Connections (continued)

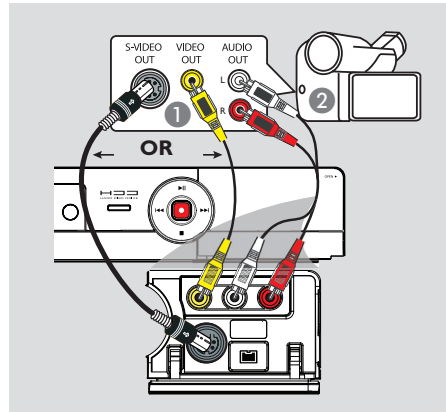
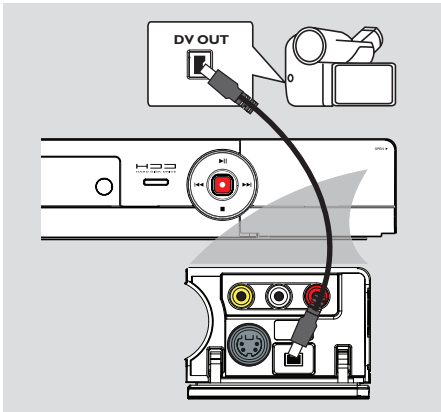

Connecting a camcorder

You can use the front sockets to copy camcorder recordings. These sockets are located behind the flap on the right hand side.

Option 1: Using the DV IN socket

Use this connection if you have a Digital Video or Digital 8 camcorder. The DV socket conforms to the i.LINK standard. It provides the best picture quality.

- Use an i.LINK 4-pin cable (not supplied) to connect the **DV IN** socket on the recorder to the appropriate DV OUT socket on the camcorder.

Before you start, press **USB/DV** on the remote control to select 'DV' as the input channel. For recording, see "Record on Hard Disk" or "Record on Recordable DVD".

Helpful Hints:

- The DV IN socket does not support a connection to a Personal Computer.
- It is not possible to record from the recorder to your camcorder via the DV IN socket on your recorder.

TIPS: Refer to the respective connected device's user manual for other possible connections.

Option 2: Using the S-VIDEO In or VIDEO In socket

Use the VIDEO (CAM1) connection if your camcorder has only a single video output (Composite Video, CVBS). *OR*, you can use the S-VIDEO (CAM2) connection if you have a Hi8 or S-VHS(C) camcorder.

- 1 Connect the **CAM 1** or **CAM 2** socket on the front panel of the recorder to the corresponding Video or S-VHS output socket on the camcorder.
- 2 Use an audio cable (red/white ends) to connect the **AUDIO L/R** sockets on the front panel of the recorder to the audio output sockets on the camcorder.

Before you start, press **SOURCE** on the remote control repeatedly to select 'CAM1' or 'CAM2' as the input channel, depending on your connections. For recording, see "Record on Hard Disk" or "Record on Recordable DVD".

Step 2: Optional Connections (continued)

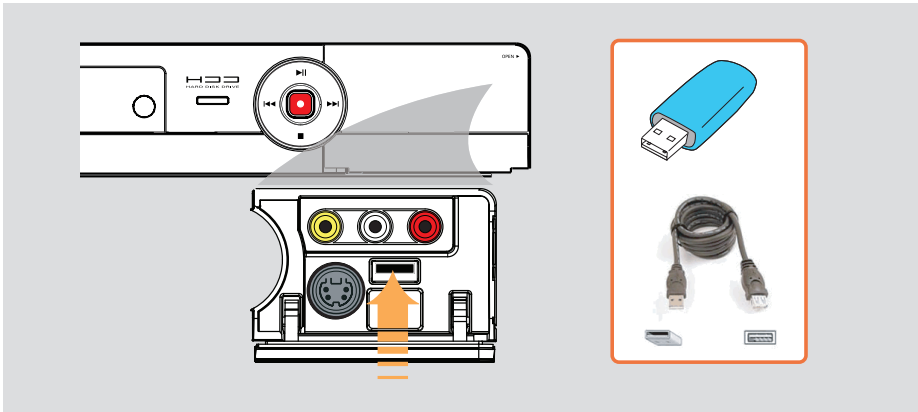

Connecting a USB flash drive or USB memory card reader

(for DVDR3460H/ DVDR3465H only)

You can only view the contents of a USB flash drive / USB memory card reader through this recorder. Editing the data and recording to the hard disk or a DVD±R/±RW is not possible.

- 1 Connect the USB flash drive / USB memory card reader directly to the USB port on the front panel (as shown in the above illustration).
- 2 Press **USB/DV** on the remote control in order to view the files stored in the USB flash drive or USB memory card reader.
- 3 To stop playback, press **STOP** or remove the USB flash drive / USB memory card reader from the USB port.

Helpful Hints:

- The USB port only supports the playback of JPEG/MP3 files.
- The USB port does not support the connection of other USB devices except to a USB flash drive / USB memory card reader.
- If the USB device does not fit into the USB port, a USB extension cable is required.

TIPS: Refer to the respective connected device's user manual for other possible connections.

Step 3: Installation and Setup

Before you start...

When you complete the connections and switch on the recorder for the first time, it is advisable that you make several basic settings.

Please see the following pages on using the Setup Menu features to programme TV channels, menu language and system clock settings. This will improve the performance of this recorder considerably.

Finding the viewing channel

- 1 Press **STANDBY-ON** on the recorder to switch it on.
- 2 Switch on the TV and set it to the correct video-in channel. You should see the blue DVD background screen.
 - Usually this channel is between the lowest and highest channels and may be called FRONT, A/V IN, VIDEO. See your TV's manual for more details.
 - Or, you may go to Channel 1 on your TV, then press the Channel down key repeatedly until you see the Video In channel.
 - Alternatively, the TV remote control may have a key or switch that chooses different video modes.

Setting the OSD language

Select the menu language for this recorder's on-screen display. The language options are different depending on your country or region. It may not correspond to the illustrations shown in the user manual.

Language settings can only be changed when the recorder is not playing or recording.

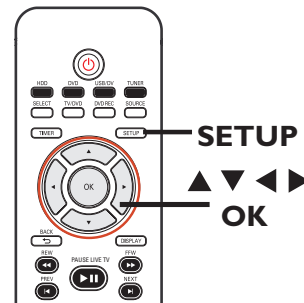

- 1 Press **SETUP**.
 - The setup menu appears on the TV.
- 2 Use ▲▼ keys to highlight  { **SETUP MENU - SETUP** } and press ► to access the menu.

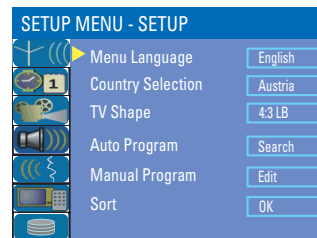

- 3 Use ▲▼ keys to highlight { **Menu Language** } and press ► to access the menu.
- 4 Use ▲▼ keys to highlight the desired language and press **OK** to confirm.

TIPS: Press ► to access the options of an item in the menu.
Press **SETUP** to exit the menu.

Step 3: Installation and Setup (continued)

Select the country of your residence

Select the country of your area for auto channel tuning.

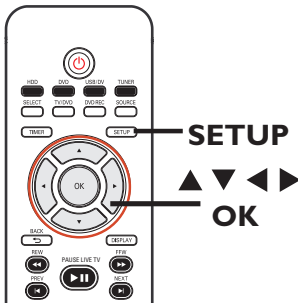

- 1 Press **SETUP** on the remote control.
→ The setup menu appears on the TV.
- 2 Use ▲▼ keys to highlight  { **SETUP MENU - SETUP** } and press ►.

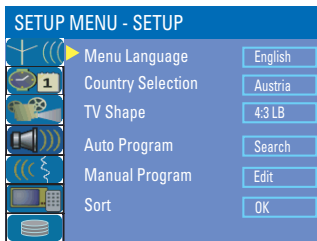

- 3 Select { **Country Selection** } and press ► to access the menu.
- 4 Use ▲▼ keys to select the country of your residence and press **OK** to confirm.

Setting your TV channel programmes

Before the recorder starts recording any TV channel programmes, you need to search for the available TV channels and store them in this recorder.

Before you start ...

Make sure you have successfully made all the required connections to the recorder, the TV and Satellite Receiver/ Cable Box (if any) and turned them on.

Tuner settings can only be changed when the recorder is not playing or recording.

- 1 Press **SETUP** on the remote control.
→ The setup menu appears on the TV.
- 2 Use ▲▼ keys to highlight  { **SETUP MENU - SETUP** } and press ►.

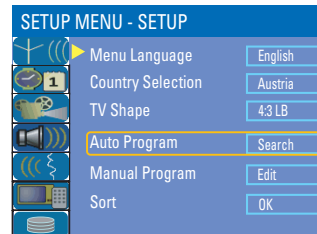

TIPS: Press ► to access the options of an item in the menu.
Press **SETUP** to exit the menu.

Step 3: Installation and Setup (continued)

- 3 Select { **Auto Program** } and press **OK**.
 → A warning message will appear. Select **OK** and press **OK** on the remote control
 → The automatic TV channel search will start. This process may take several minutes. Once complete, the total number of channels found will appear on the TV.

To modify or sort the TV channels, see the chapter “Setup Menu Options – GENERAL settings” for more information.

Setting the date & time

This recorder has an automatic date and time setting feature. The date and time settings are set according to the broadcast channel information of the selected preset channel.

- 1 Press **SETUP**.
 → The setup menu appears.
- 2 Use ▲▼ keys to highlight  { **SETUP MENU - DATE / TIME** } and press ► to access the menu.

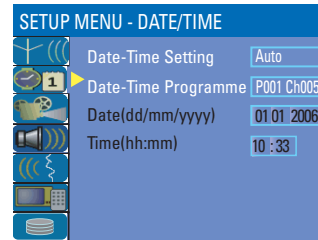

- 3 Use ▲▼ keys to highlight { **Date -Time Programme** } press ► to access the options.
- 4 Select the desired programme channel to for date/time settings and press **OK** to confirm.
 → The date and time fields will be set according to the broadcast information of the selected programme channel.
- If the recorder has not set the time and date correctly, you can further adjust the clock settings. See the chapter “Setup Menu Options – DATE/TIME Settings”.
- 5 Once complete, press ◀ to return to the previous menu.
- 6 Press **SETUP** to exit.

The basic installation is now complete. This recorder is ready for use!

TIPS: Press ► to access the options of an item in the menu.
 Press **SETUP** to exit the menu.

Control TV programmes

Switching on to TV programme

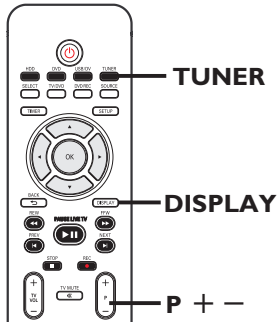

- 1 Switch on the TV to the correct programme number for the recorder (e.g. 'EXT', '0', 'AV').
- 2 Press **STANDBY-ON** to switch on the recorder.
 - If no TV programme appears on the screen, press **TUNER** on the remote control.
- 3 Press **P + -** to select a TV channel.
 - The selected TV channel will appear on the status window.
 - The active TV programme will be stored automatically to the temporary HDD storage in this recorder. This information is shown on the Time Shift video bar.
- To display or remove the Time Shift video bar, press the **DISPLAY** key repeatedly.



For more information about the temporary HDD storage (Time Shift Buffer), see next page.

Pause live TV function

You may be interrupted whilst watching your favorite TV program. You can pause the show by pressing **PAUSE LIVE TV ▶||**.

To resume playback of the program at the scene it was interrupted, press **PAUSE LIVE TV ▶||** again. You can 'pause' the live TV broadcast up to a maximum period of 6 hours. It behaves exactly as if you were in control of the live broadcast.

If you want to return to the live TV programme, press and hold ▶ .

Instant Replay function

Whilst watching a live TV programme, you can press ◀ on the remote control to jump back 10 seconds upon every single press for instant replay.

To view from the beginning of the time shift buffer, press and hold ◀ on the remote control.

If you want to return to the live TV programme, press and hold ▶ .

TIPS: Press **DISPLAY** to display the time shift video bar or help text.

Before Recording

About temporary HDD storage (Time Shift Buffer)

Once you switch on this recorder, the currently selected TV programme will be stored in a temporary hard disk storage called 'Time Shift Buffer' (TSB). The '**TSB**' captures up to 6 hours of TV programmes.

In tuner mode, the Time Shift video bar will appear on the screen, it indicates the status and timing of the TV programmes stored in the temporary HDD storage. You can choose to display or remove the video bar by pressing the **DISPLAY** key on the remote control.

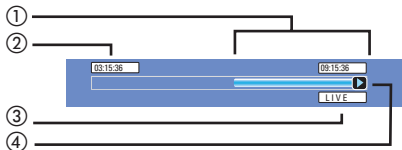

The Time Shift video bar consists of the following information :

- ① Content temporarily saved in the time shift buffer.
- ② The TV programme start time.
Once it has exceeded 6 hours, the content stored at the beginning will be deleted and the start time will be updated accordingly.
- ③ Status of source of video input.
"LIVE" or the time of current playback being viewed "HH:MM:SS".
- ④ Icon which shows the status of the time shift buffer.
 - ▶ – playback of content stored in the time shift buffer.
 - – marks the beginning of content recording.
 - – marks the current recording in progress.
 - ⏸ – the current screen has been paused from playback. (This will not pause recording).

WARNING!

The TV programmes stored in the temporary HDD storage will be deleted once it has exceeded the storage buffer or when you press **STANDBY-ON** to turn off the recorder.

In addition, executing the following actions will also clear the contents in the temporary HDD storage:

- Press **USB/DV, DVD REC** or **SOURCE** on the remote control.

Alternatively,

- Use the option { **Delete HDD** } to erase all contents of your hard disk storage. See the section "Before Recording – HDD Settings" for details.

TIPS: Press **DISPLAY** to display the time shift video bar or help text.

Before Recording (continued)

Default Recording settings

The default recording settings will allow you to preset auto chapter markers and the preferred mode of recording quality for HDD recording.

- 1 Press **SETUP** on the remote control.
→ The setup menu appears on the TV.
- 2 Use ▲▼ keys to highlight  { **SETUP MENU - GENERAL** } and press ► to confirm.

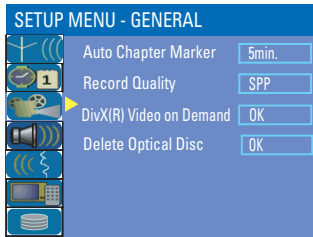

- 3 Use ▲▼ keys to select the setting you wish to change and press **OK** to confirm.
→ Instructions and explanation of the options are provided in the following pages.
- 4 To exit, press **SETUP**.

Auto Chapter Markers

You can insert chapter markers within a title during recording. This allows you to access to specific points on the recording.

- 1 Use ▲▼ keys to highlight { **Auto Chapter Marker** } and press ► to access its options.
- 2 Use ▲▼ keys to select your preferred setting.
- 3 Press **OK** to confirm.

Default Recording Quality

The setting defines the picture quality of recordings and the maximum recording time on the HDD.

Important! When copying from the HDD to a recordable DVD, the mode of recording quality for the selected recording in the HDD will automatically be transferred. It is not possible to select another mode of recording quality.

- 1 Use ▲▼ keys to highlight { **Record Quality** } and press ► to access its options.
- 2 Use ▲▼ keys to select your preferred mode of record quality.
- 3 Press **OK** to confirm.

TIPS: Press ◀ to go back to previous menu item.
Press **SETUP** to exit the menu.

Before Recording (continued)

GENERAL settings (underlined options are the factory default settings)

Auto Chapter Marker

You can insert chapter markers within a title during recording. This lets you access to specific points on the recording.

Press ► to access the menu and use ▲▼ keys to select one of the options.

- { 5min. } – Chapter markers are inserted during recording at every 5 minutes interval.
- { 10min. } – Chapter markers are inserted during recording at every 10 minutes interval.
- { 20min. } – Chapter markers are inserted during recording at every 20 minutes interval.
- { 30min. } – Chapter markers are inserted during recording at every 30 minutes interval.
- { Off } – The feature is disabled.

Record Quality

Select this option to preset your preferred mode of record quality.

Press ► to access the menu and use ▲▼ keys to select one of the options.

Record Quality	Hours of Recording that can be stored		
	160GB HDD	250GB HDD	DVD±R/ DVD±RW
HQ High Quality	34	50	1
SP Standard Play	68	100	2
SPP Standard Play Plus	85	130	2.5
LP Long Play	102	150	3
EP Extended Play	136	200	4
SLP Super Long Play	200	300	6
SEP Super Extended Play	270	400	8

Values are estimates only. Parts of the HDD storage capacity will be reserved for the operations of this recorder and time shifting.

Record on Hard Disk

IMPORTANT!

Unrecordable pictures

Television programmes, films, video tapes, discs, and other materials may be copy-protected and therefore cannot be recorded on this recorder.

Recording from various sources

You can choose to record a TV programme or make recordings from an external device to the HDD.

Recording TV programmes

Follow the instructions below to record TV programmes onto the HDD, where you can store for future viewing or copy to a recordable DVD.

- 1 In tuner mode, press the **DISPLAY** key on the remote control to display the time shift video bar.
- 2 Use **◀◀ / ▶▶** keys to search for the beginning of the scene in the temporary HDD storage where you want to start recording.
- 3 Press **REC ●** on the remote control to start recording.
→ To cancel, press **SELECT**.
- To save all current programmes stored in the time shift buffer, press and hold **REC ●**.
- 4 To stop recording, press **STOP ■** on the remote control.

To record directly to a recordable DVD, see the chapter "Record on Recordable DVD".

Recording from a DV camcorder

You can record video directly from a connected DV camcorder onto the HDD, where you can edit it easily and copy to a recordable DVD if required.

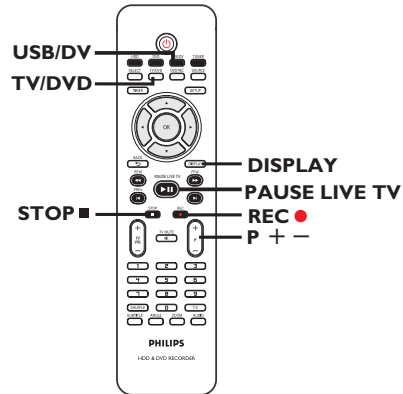

IMPORTANT!

– If you press **USB/DV** on the remote control, the contents in the **TSB** will be deleted.

TIPS: Set the appropriate mode of record quality for HDD recording, the same record quality will be transferred from HDD to a recordable DVD, see "Before Recording."

Record on Hard Disk (continued)

- 1 Connect the DV camcorder to the **DV IN** socket on the front panel of this recorder.
- 2 Find the footage on the DV camcorder that you want to start recording from and set the camcorder to pause mode.
- 3 Switch on the TV to the correct programme number for the recorder (e.g. 'EXT', '0', 'AV').
- 4 Switch on the recorder and press **USB/DV** on the remote control.
→ An information box will be displayed.

System State: **Stop** DV State: **Stop**
Record to Hard Disk As **Standard Play**
Elapsed Time: **00:00:00** Remaining Time: **00:00:00**

- Press **SELECT** repeatedly to change the mode of record quality.
- 5 Press **REC ●** to start recording and press the **PLAY** button on the DV camcorder to start playback.
- To pause the recording, press **PAUSE LIVE TV ►►**.
To resume recording, press **PAUSE LIVE TV ►►** again.
→ A new chapter marker is created after recording restarts.
- 6 To stop recording, press **STOP ■**.
→ A new title will be created when you begin another recording.

To record directly to a recordable DVD, see the chapter "Record on Recordable DVD".

Recording from an external device (Camcorder/VCR/ DVD player)

A copy protection system has been built into this recorder to prevent the transfer of data from pre-recorded DVDs or other copy protected material onto the recordable DVD. You can only store the contents in the temporary HDD storage of this recorder.

Note: Set the preferred mode of record quality before proceeding, see "Before Recording - Default Recording Settings."

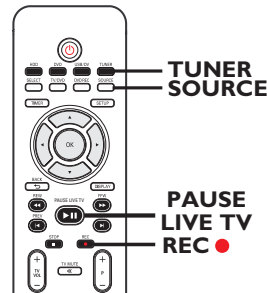

- 1 Connect the external device to this recorder (See the chapter "Step 2: Optional Connections").
- 2 Switch on the TV to the correct programme number for the recorder (e.g. 'EXT', '0', 'AV').
- 3 Press **STANDBY-ON** to switch on the recorder.
→ If no TV programme appears on the screen, press **TUNER** on the remote control.

TIPS: Set the appropriate mode of record quality for HDD recording, the same record quality will be transferred from HDD to a recordable DVD, see "Before Recording."

Record on Hard Disk (continued)

- 4 Press **SOURCE** repeatedly to select the correct input channel that matches the connected socket of the device.
 - { **EXT 1** } : EXT 1 TO TV I/O scart socket at the back.
 - { **EXT 2** } : EXT 2 AUX I/O scart socket at the back.
 - { **CAM 1** } : VIDEO socket on the front.
 - { **CAM 2** } : S-VIDEO socket on the front.
- 5 Press **REC** ● to start recording.
 - You can also press **REC** ● repeatedly to increase the recording time in 30-minute increments.
- 6 Start playback on the connected device.
 - The content from the connected device will be recorded.
- 7 To stop the recording before the scheduled ending, press **STOP** ■ .

To record directly to a recordable DVD, see the chapter “Record on Recordable DVD”.

Instant recording

This function allows you to make a recording with a pre-determined duration without using the timer programming.

- 1 Press **REC** ● repeatedly to toggle between recording options of 30-minute increments (30, 60 and up to 360-minutes of recording).
- 2 The recorder will stop recording at the designated end time.
 - If you wish to stop the recording before the scheduled time, press **STOP** ■ .

TIPS: Set the appropriate mode of record quality for HDD recording, the same record quality will be transferred from HDD to a recordable DVD, see “Before Recording.”

Record on Hard Disk (continued)

Watch playback from another source during recording

While recording is in progress, you can watch another TV channel or the playback from another audio/video device which is connected to this recorder.

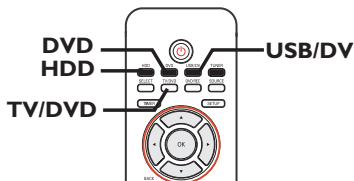

Watching playback from another device

This is only possible if the recorder is connected to the TV using the EXT1 TO TV-I/O socket.

- Press **TV/DVD** to view the picture from the device which is connected to the EXT2 AUX-I/O socket of this DVD recorder.

Watching another TV channel

If there is no device connected to the EXT2 AUX-I/O socket, pressing **TV/DVD** will switch to TV mode.

- Use the TV's remote control to change the channels.
→ The message "TV/LOOP" will be displayed on the recorder's system display panel.
- To switch back to recorder mode, press **TV/DVD** on the remote control.

Helpful Hint:

– Remember to switch the TV back to its video input channel if you want to watch the TV channel through the recorder or playback the recorded disc.

TIPS: Set the appropriate mode of record quality for HDD recording, the same record quality will be transferred from HDD to a recordable DVD, see "Before Recording."

Watching HDD title playback

You can playback another HDD title whilst recording is in progress.

- Press **HDD** to view the HDD title list. Use **▲▼** keys to highlight the title you want and press **PAUSE LIVE TV ►II**.

Watching DVD playback

You can playback another DVD title whilst recording is in progress.

- Press **DVD** to view the disc menu of the DVD in the tray. Use **▲▼** keys to highlight the title you want and press **PAUSE LIVE TV ►II**.

Watching playback from USB device

(for DVDR3460H/ DVDR3465H only)

You can watch playback from the connected USB device whilst recording is in progress.

- Press **USB/DV** twice to view the content menu of the connected USB device. Use **▲▼** keys to highlight the title you want and press **PAUSE LIVE TV ►II**.

Record on Recordable DVD

IMPORTANT!

Unrecordable pictures

Television programmes, films, video tapes, discs, and other materials may be copy-protected and therefore cannot be recorded on this recorder.

Copying from HDD to a recordable DVD

You can copy a recorded title(s) from the HDD (hard disk drive) to a recordable DVD.

The time taken to copy content from the HDD to a recordable DVD depends on the record quality of the HDD recordings.

It is not possible to change the mode of record quality during the copying process. As such, it is important that you choose the appropriate record quality when you first set up the recording to the HDD.

The copying process is done at a higher speed than the recording. The following information will be stored on the disc :

- Title/name of recording
- Date of recording
- Time of recording
- Record quality mode/ length of recording
- Index picture of title

Discs for recording

There are several formats of recordable DVD discs which can be used with this recorder:



DVD±RW (ReWritable DVD discs)

- Discs that are rewritable can be used for multiple recordings once the existing data has been erased.



DVD±R (Recordable DVD discs)

- Discs that can only be used for a single recording. Each new recording is always added at the end of all previous recordings as existing recordings cannot be overwritten.
- Editing can be made on DVD±R discs as long as they have not been finalised.
- To play a DVD±R disc on another DVD player, it must be finalised [see the section “Playing your recordings on other DVD players (DVD±R only)”]. After this is done, no more content can be added to the disc.

TIPS: Ensure that there is sufficient space available on the DVD±R before recording. You have to finalise the DVD±R before it can be played on other players, see “Edit Recordings – Recordable DVD”.

Record on Recordable DVD (continued)

Recording from various sources

You can choose to copy your recordings from the HDD or an external device to a recordable DVD. The storage capacity of the disc depends on the record quality that was selected for the recording in the recorder or device, see the previous page.

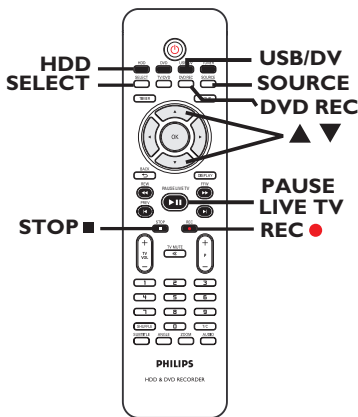

Recording from the HDD

- 1 Switch on the TV to the correct programme number for the recorder (e.g. 'EXT', '0', 'AV').
- 2 Insert a recordable DVD into the recorder.
- 3 Press **HDD** on the remote control.
→ The HDD content menu appears on the screen.

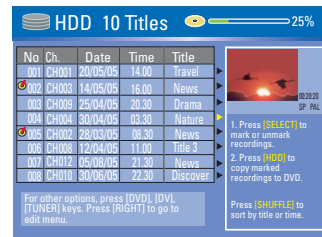

- 4 Use ▲▼ keys to highlight the title/titles and press **SELECT** to mark the titles for copy to DVD.
- If you have many HDD title recordings, use ◀ (PREV) or ▶ (NEXT) to view the previous/ next page of HDD titles for selection.
- 5 Press **HDD** on the remote control.
→ Recording to the recordable DVD will begin. The dubbing icon  will be displayed at the bottom right corner of the screen.
→ Once complete, the icon will not be shown.
- 6 To stop recording, press **STOP** ■ on the remote control.

Helpful Hint:

– During selection of recordings for copying, press **SHUFFLE** on the remote control to sort according to the titles of recording.

TIPS: Ensure that there is sufficient space available on the DVD±R before recording. You have to finalise the DVD±R before it can be played on other players, see "Edit Recordings – Recordable DVD".

Record on Recordable DVD (continued)

Recording from an external device/ VCR/ DV Camcorder

- Switch on the TV to the correct programme number for the recorder (e.g. 'EXT', '0', 'AV').
- Insert a recordable DVD into the recorder.
- Press **DVD REC** to switch to direct recording mode.
→ An information box will be displayed on the screen.
- Press **SOURCE** repeatedly to select from the various options:

System State: Stop
Record to Optical Disc As **Standard Play Plus**
Elapsed Time: 00:00:00 Remaining Time: 00:00:00

{ Tuner }

Input source from TV programmes.

{ CAM 1 }

Input source from the device connected to the VIDEO and AUDIO L/R sockets on the front panel.

{ CAM 2 }

Input source from the device connected to the S-VIDEO and AUDIO L/R sockets on the front panel.

{ EXT 1 }

Input source from the device connected to the EXT1 TO TV-I/O scart socket on the rear panel.

{ EXT 2 }

Input source from the device connected to the EXT2 AUX-I/O scart socket on the rear panel.

Alternatively,

- Press **USB/DV** to record from the DV camcorder connected to the DV IN socket on the front panel.

- Press **SELECT** to toggle between the different modes of record quality.

Record Quality	Hours of Recording that can be stored		
	160GB HDD	250GB HDD	DVD±R/DVD±RW
HQ High Quality	34	50	1
SP Standard Play	68	100	2
SPP Standard Play Plus	85	130	2.5
LP Long Play	102	150	3
EP Extended Play	136	200	4
SLP Super Long Play	200	300	6
SEP Super Extended Play	270	400	8

Values are estimates only. Parts of the HDD storage capacity will be reserved for the operations of this recorder and time shifting.

- Press **REC** on the remote control.
→ Recording to the recordable DVD will begin.
- To stop recording, press **STOP** on the remote control.

Helpful Hint:

– All title selections and settings will be lost once you replace or remove the recordable DVD.

To edit your recordings on the recordable DVD, see “Edit Recordings – Recordable DVD”.

TIPS: Ensure that there is sufficient space available on the DVD±R before recording. You have to finalise the DVD±R before it can be played on other players, see “Edit Recordings – Recordable DVD”.

Timer Recording

About timer recording

Use 'Timer Recording' to automatically start and stop a recording at a later date/ time. The recorder will tune to the right programme channel and begin recording at the specified time.

With this recorder, you can pre-programme up to **8 recordings**.

To make a timer recording, your recorder needs to know:

- The date you want to make the recording.
- The recording input source.
- The start and stop time of the recording.
- The mode of record quality, see the chapter "Before Recording – GENERAL settings.

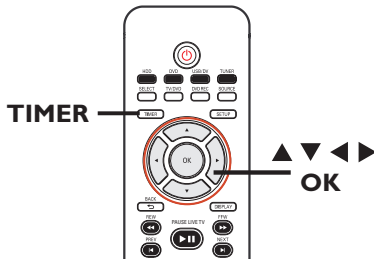

About 'VPS/PDC'

'VPS' (Video Programming System) or 'PDC' (Programme Delivery Control) controls the start and duration of TV channel recordings. If a TV programme starts earlier or ends later than was scheduled, the recorder will start/end the recording accordingly.

The VPS/PDC recording option can only be used to record an entire programme from its beginning to the end. To set a timer that is different from the VPS/PDC broadcast time, you must disable the VPS/PDC recording option. Programme Delivery Control (PDC) is not available to users in the UK.

Timer recording (SHOWVIEW®/ VIDEO Plus+ System)

This is a simple timer programming system. To use, enter the SHOWVIEW® programming number / VIDEO Plus+ PlusCode number associated with your television programme. You can find this number in your TV listings magazine.

All the information needed by this recorder for programming is contained in the programming number.

- 1 Switch on the TV. Select the correct Video In channel at the TV.
- If you are recording directly to a DVD disc, insert the recordable DVD before proceeding to step 2.
- 2 Press **TIMER** on the remote control.
 - The timer schedule appears.

Timer Schedule							
	Source	Rec Mode	Date	Start	End	Rec To	VPS
1							
2							
3							
4							
5							
6							

- 3 Use ▲▼ keys to highlight the next available empty slot and press **OK**.
 - The SHOWVIEW® / VIDEO Plus+ System menu appears.

SHOWVIEW System	
Please enter the programming number for your recording. Select [MANUAL] for manual timer recording. Press [BACK] to go to the timer list.	
<input style="width: 100%;" type="text"/>	
<input type="button" value="CONFIRM"/>	<input type="button" value="MANUAL"/>

TIPS: Set the appropriate mode of record quality for HDD recording, the same record quality will be transferred from HDD to a recordable DVD.

Timer Recording (continued)

- 4 Use the **numeric keypad 0-9** to enter the SHOWVIEW® / PlusCode programming number for the show you wish to record and press **OK**. (e.g. : 5-312-4 or 5,312 4, key in '53124').
- To cancel the SHOWVIEW® / PlusCode programming, press **BACK** on the remote control.
- 5 To confirm your entry, select **CONFIRM** in the menu and press **OK**.
→ The timer editor menu appears.

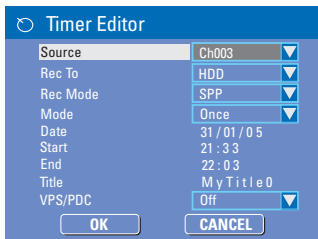

- 6 Use **▲▼** keys to select an entry in the menu and press **▶** to enter its options.
 - { **Source** }
 - Use **▲▼** keys to select the recording input source.
 - { **Rec To** }
 - Use **▲▼** keys to select { **HDD** } or { **DVD** } to enter the recording destination.
 - { **Rec Mode** }
 - Use **▲▼** keys to select your option.
 - { **Mode** }
 - Use **▲▼** keys to select { **Once** }, { **Daily** }, { **Weekly** }, { **Mon-Fri** }, { **Mon-Sat** }, { **Weekend** } recordings.
 - { **Date** }
 - Use **▲▼** keys or the **numeric keypad 0-9** to enter the date for recording.
 - { **Start** }
 - Use **▲▼** keys or the **numeric keypad 0-9** to enter the start time of recording.

- { **End** }
 - Use **▲▼** keys or the **numeric keypad 0-9** to enter the end time of recording.
- { **Title** }
 - Use **▲▼◀▶** keys to select the alphanumeric options to enter the title of your recording.
- { **VPS/PDC** }
 - Use **▲▼** keys to turn on/off the VPS/PDC mode (See the previous page “About VPS/PDC”)

- 7 Select **OK** in the menu and press **OK**.
→ The system will store the timer entry and return to the timer schedule list.
- 8 Press **TIMER** to exit the menu.
- 9 Press **STANDBY-ON** to turn off the recorder.
 - If the recorder is not in standby mode, a warning message will appear three minutes before the recording starts.
 - The ‘**TIMER**’ icon will light up on the display panel if a timer recording is set.

TIPS: Set the appropriate mode of record quality for HDD recording, the same record quality will be transferred from HDD to a recordable DVD.

Timer Recording (continued)

Timer recording (manually)

- Switch on the TV. Select the correct Video In channel at the TV.
- If you are recording directly to a DVD disc, insert the recordable DVD before proceeding to step 2.
- Press **TIMER** on the remote control.
→ The timer schedule appears.

	Source	Rec Mode	Date	Start	End	Rec To	VPS
1	CH003	SP	31/01/06	10:33	11:03	HDD	On
2	EXT 1	EP	05/01/06	04:00	05:30	DVD	Off
3	CH008	SP	30/03/06	10:00	11:15	HDD	On
4							
5							
6							

- Use ▼ keys to highlight the next available empty slot and press **OK**.
→ The **SHOWVIEW@/ VIDEO Plus+ System** menu appears.

SHOWVIEW System

Please enter the programming number for your recording. Select [MANUAL] for manual timer recording. Press [BACK] to go to the timer list.

CONFIRM **MANUAL**

- Select **MANUAL** in the menu and press **OK**.
→ The timer editor menu appears.

Timer Editor

Source: Ch003

Rec To: HDD

Rec Mode: SPP

Mode: Once

Date: 31 / 01 / 05

Start: 21 : 33

End: 22 : 03

Title: My Title 0

VPS/PDC: Off

OK **CANCEL**

- Use ▲▼ keys to select an entry in the menu and press ► to enter its options.

{ **Source** }

– Use ▲▼ keys to select the recording input source.

{ **Rec To** }

– Use ▲▼ keys to select { **HDD** } or { **DVD** } to enter the recording destination.

{ **Rec Mode** }

– Use ▲▼ keys to select your option.

{ **Mode** }

– Use ▲▼ keys to select { **Once** }, { **Daily** }, { **Weekly** }, { **Mon-Fri** }, { **Mon-Sat** }, { **Weekend** } recordings.

{ **Date** }

– Use ▲▼ keys or the **numeric keypad 0-9** to enter the date for recording.

{ **Start** }

– Use ▲▼ keys or the **numeric keypad 0-9** to enter the start time of recording.

{ **End** }

– Use ▲▼ keys or the **numeric keypad 0-9** to enter the end time of recording.

{ **Title** }

– Use ▲▼◀▶ keys to select the alphanumeric options to enter the title of your recording.

{ **VPS/PDC** }

– Use ▲▼ keys to turn on/off the VPS/PDC mode (See the previous page “About VPS/ PDC”)

- Select **OK** in the menu and press **OK**.

→ The system will store the timer entry and return to the timer schedule list.

- To cancel the above timer setting, press **SELECT** on the remote control.

TIPS: Set the appropriate mode of record quality for HDD recording, the same record quality will be transferred from HDD to a recordable DVD.

Timer Recording (continued)

- 7 Press **TIMER** to exit the menu.
- 8 Press **STANDBY-ON** to turn off the recorder.
 - If the recorder is not in standby mode, a warning message will appear three minutes before the recording starts.
 - The 'TIMER' icon will light up on the display panel if a timer recording is set.

Helpful Hint:

– Set the timer recording one minute ahead of the programme's start time. This helps ensure the entire programme is recorded as the disc requires about 30 seconds to prepare for recording.

Setting a timer recording from an external Cable Box/Satellite Receiver

If you have a Satellite Receiver/Cable Box connected to this recorder (see the section "Step 2: Optional connections – Connecting to a Cable Box or Satellite Receiver") follow the steps described below to programme the recordings.

- 1 Select the channel you want to record at the Satellite Receiver/Cable Box.
- 2 Programme the recording with the required information. Follow the steps 1 to 4 of "Timer Recording (manually)" on the previous page.
 - When selecting options for { **Source** } choose { **EXT 2** } as the input channel and press **OK** to confirm.
- 3 Keep the Satellite Receiver/Cable Box switched on for the recording.
- 4 Press **STANDBY-ON** to turn off the recorder.

TIPS: Set the appropriate mode of record quality for HDD recording, the same record quality will be transferred from HDD to a recordable DVD.

Changing/ Deleting a timer recording

- 1 Switch on the TV. Select the correct Video In channel at the TV.
- 2 Press **TIMER** on the remote control.
 - The timer schedule appears.

	Source	Rec Mode	Date	Start	End	Rec To	VPS
1	CH003	SP	31/01/06	10:33	11:03	HDD	On
2	EXT 1	EP	05/01/06	04:00	05:30	DVD	Off
3	CH008	SP	30/03/06	10:00	11:15	HDD	On
4							
5							
6							

- 3 Use **▲▼** keys to select a timer programme which you want to change/delete.
- 4 **To delete the timer entry**, press **SELECT** on the remote control.
- 5 **To change the timer schedule**, press **OK** to enter the timer editor menu of the selected timer programme.

Timer Editor	
Source	Ch003
Rec To	HDD
Rec Mode	SPP
Mode	Once
Date	31 / 01 / 05
Start	21 : 33
End	22 : 03
Title	My Title 0
VPS/PDC	Off
<input type="button" value="OK"/> <input type="button" value="CANCEL"/>	

- 6 Select the entry field and make the necessary changes.
- 7 Once complete, select **OK** in the menu and press **OK** to save the changes.
- 8 To cancel changes, select **CANCEL** in the menu and press **OK**.
- 9 Press **TIMER** to exit the menu.

Playback from Hard Disk

Playback your HDD recordings

Each recording stored on the HDD is displayed in the HDD content menu with an index picture.

- 1 Press **HDD** on the remote control.
→ The HDD content menu appears.
- 2 Use **▲▼** keys to highlight a title and press **OK** on the remote control to start playback.
- If you have many HDD title recordings, use **◀** (PREV) or **▶** (NEXT) to view the previous/ next page of HDD titles for selection.

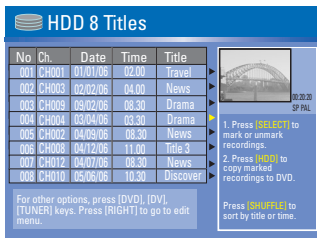

- 3 During playback, you can use the following keys on the remote control to access additional playback features.

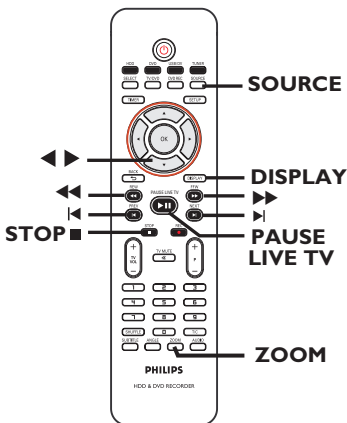

- ◀▶ – move to the previous or next chapter.
- ◀▶▶▶ – press this key to start fast backward/forward search.
- press this key again to increase the search speed.
- ▶ – jump forward by 30 seconds.
- ◀ – jump backward by 10 seconds.

PAUSE LIVE TV ▶||

- starts playback
- view a still picture.

DISPLAY

- displays the Time Shift video bar. Press repeatedly to remove the video bar display.
- displays the help text for the selected function.

STOP ■

- stop playback.

ZOOM

- zoom in and out of a still/paused picture.

Helpful Hint:

- During selection of recordings for playback, press **SHUFFLE** on the remote control to sort according to the titles of recording.

Playback from Disc

Playable discs

Using this recorder, you can play and record on the following discs:

Recording and Playback

DVD±RW

(ReWritable DVD); can be recorded on and overwritten repeatedly.



DVD±R

(Recordable DVD); can be recorded on only once.



Playback only:

DVD Video

(Digital Versatile Disc)



CD-RW (CD-ReWritable)
Audio/ MP3/ JPEG contents



CD-R (CD-Recordable)
Audio/ MP3/ JPEG contents



Audio CD (Compact Disc Digital Audio)



MP3-Disc



Video CD

(Formats 1.0, 1.1, 2.0)



Super Video CD



DivX Disc



(DivX 3.11, 4.x, 5.x, 6)



IMPORTANT!

- If the inhibit icon ( Error) appears on the TV screen when a key is pressed, it means the function is not available on the current disc or at the current time.
- DVD discs and players are designed with regional restrictions. Before playing a disc, make sure the disc is for the same region as your player.
- Do not push on the disc tray or put any objects other than discs on the disc tray. It may cause the disc player to malfunction.

Starting disc playback

- 1 Press **STANDBY-ON** to switch on the recorder.
- 2 Press **OPEN/CLOSE**  on the front of the recorder.
→ The disc tray opens.
- 3 Place the disc onto the tray with the label facing up, then press **OPEN/CLOSE** .
- 4 Switch on the TV. Select the correct Video In channel at the TV (See the chapter “Step 3: Installation and Setup – Finding the viewing channel”).
- 5 Press **DVD** to access the disc content menu.
→ Playback starts automatically or press **PAUSE LIVE TV** .
- If the disc has its own menu, this will be loaded. Otherwise, the recorder will launch an index screen.
- For more playback features, see the chapter “Additional Playback Features”.

TIPS: Some discs cannot be played on this recorder due to the configuration and characteristics of the disc, or due to the condition of recording and authoring software.

Playback from Disc (continued)

Playing a DVD video disc

The DVD disc is usually formatted with a disc menu. You may have to make your selection (e.g., subtitle or audio language) within the disc menu.

- 1 Insert a DVD disc. Press **DVD** on the remote control.

If the disc menu appears on the TV

- Use the **numeric keypad 0-9** to input your selection or use **◀▶▲▼** keys to select a play option and press **OK** to start playback.

To select the previous or next chapter

- During playback, press **◀** or **▶**.
- 2 To stop playback, press **STOP ■**.

Playing a (Super) Video CD

(Super) Video CDs may feature 'PBC' (Play Back Control). This allows you to play the video CDs interactively, following the menu on the display.

- 1 Insert a (Super) Video CD. Press **DVD** on the remote control.

If the 'PBC' is on, the disc index menu will appear on the TV

- 2 Use **numeric keypad 0-9** to input your selection or to select a play option.
 - Press **BACK ⏪** on the remote control to return to the previous menu.
 - To turn on/off the Playback Control mode, press **DISPLAY** key on the remote control twice during playback to access the playback menu options.
 - Use **▲▼** keys to select { **PBC** } and press **▶** to select either { **PBC On** } or { **PBC Off** }.
- 3 To stop playback, press **STOP ■**.

Playing an audio CD

- 1 Insert an audio CD. Press **DVD** on the remote control.
 - Playback starts automatically or press **PAUSE LIVE TV ▶||** to start play.
- 2 To stop playback, press **STOP ■**.

TIPS: Some discs cannot be played on this recorder due to the configuration and characteristics of the disc, or due to the condition of recording and authoring software.

Playback from Disc (continued)

Playing a recordable DVD

- 1 Insert a recordable DVD. Press **DVD** on the remote control.
→ The Index Picture screen appears.
- 2 Use **▲▼** keys to select a title and press **PAUSE LIVE TV ►||** to start playback.
- 3 To stop playback, press **STOP ■**.

Helpful Hint:

– If the message ‘BLANK’ appears on the display panel, this means that there are no recordings on this disc.

Playing a DivX disc

This recorder supports the playback of DivX® movies which you can copy from your computer onto a CD-R/RW or recordable DVD.

- 1 Insert a DivX disc. Press **DVD** on the remote control.
→ The disc content menu appears.
- If the DivX movie contains external subtitles, you have to first select the subtitle file from the file list. Use **▲▼** keys to select the files for playback and press **SELECT** to confirm your selection.
- 2 Press **PAUSE LIVE TV ►||** to start playback.
- During playback, you can press **DISPLAY** on the remote control to display the disc content menu.

Helpful Hints:

– Subtitle files with the following filename extensions (.srt, .smi, .sub, .sami) are supported.
– It is normal to experience an occasional pixelation during DivX playback due to poor encoding of the content.

TIPS: Some discs cannot be played on this recorder due to the configuration and characteristics of the disc, or due to the condition of recording and authoring software.

Playing a MP3 disc

- 1 Insert a MP3 CD. Press **DVD** on the remote control.
→ The disc content menu appears.

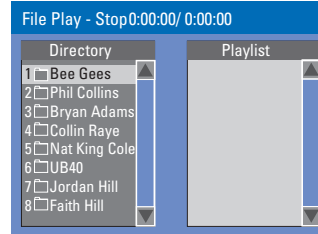

Note: It may require a longer time for the recorder to display the disc content menu on the TV due to the large number of songs/pictures compiled into one disc.

- 2 Use **▲▼** keys to navigate within the menu and press **OK** to access the folder/album.
- 3 Use **▲▼** keys to select the track/file to play.
 - To go to the previous menu, press **BACK ⏪**.
- 4 To create a playlist, highlight the track/file and press **SELECT**.
→ The selected tracks/files will appear on the right screen.
→ Use **◀▶** keys to toggle between the left and right screens.
- 5 Press **PAUSE LIVE TV ►||** to start playback.
- 6 During playback, you can press **◀▶** to select the next/previous track.
- 7 To stop playback, press **STOP ■**.

Helpful Hints:

– Only the first session of a multi-session CD will play back.
– It is normal to experience an occasional “skip” while listening to your MP3 disc.

Playback from Disc (continued)

Playing a picture disc (or musical slide show)

You can display JPEG pictures in the selected roll automatically one after the other.

- 1 Insert a JPEG picture disc (CD, CD-R/RW, DVD). Press **DVD** on the remote control.
 - The disc content menu appears.
- 2 Use **▲▼** keys to navigate within the menu and press **OK** to access the folder/album.
- 3 To create a playlist, highlight the track/file and press **SELECT**.
 - The selected tracks/files will appear on the right screen.
- To remove the track/file from the playlist, use **◀▶** keys to move to the right screen. Use **▲▼** keys to select the track/file, press **SELECT** once.
- 4 You can select to playback from the original disc content or from the playlist, just use **◀▶** keys to move to the correct screen before selecting the track/file for playback.

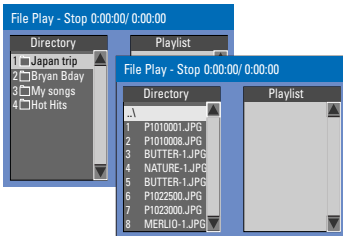

If the disc contains MP3 music and JPEG picture files, you can start a musical slide show playback,

- Select an MP3 file and press **OK** to start playback, then select a picture file in the menu and press **OK** to start the musical slide show playback.

TIPS: Some discs cannot be played on this recorder due to the configuration and characteristics of the disc, or due to the condition of recording and authoring software.

- 5 During playback, you can press **DISPLAY** on the remote control to access various settings for the slide show playback.

File Play		
Type	PIC	
Mode	Normal	
Track	Play	
Wipe	Top to bottom	Top to bottom
Zoom	Fitscreen	Down to top
Rotate	Clockwise 0	Left to right
		Right to left
		Extend center V

- Press **ZOOM** on the remote control to enlarge the picture.
- 6 To stop playback, press **STOP** ■.

Playable JPEG picture disc

This recorder can read JPEG pictures stored on a CD-ROM, Picture CD, or DVD.

File format:

- The file extension has to be '.JPG,' '.JPE' or '.JPEG.'
- Only DCF-standard still pictures or JPEG pictures (eg. TIFF) can be displayed.
- It cannot playback moving pictures, Motion JPEG, pictures in non-JPEG formats or pictures associated with sound.
- The recorder may require a longer time to display the disc content on the TV due to the large number of songs/pictures compiled onto one disc.

Playback from USB

Playing from a USB flash drive/ USB memory card reader

(for DVDR3460H/ DVDR3465H only)

This USB port only supports the playback of JPEG/MP3 files. It is not possible to record the data from the USB port to this DVD recorder.

- 1 Insert a USB flash drive or USB memory card reader into the USB port.
- 2 Press **USB/DV** twice on the remote control to access the data in the USB drive.
→ The USB content menu appears.
- 3 Use **▲▼** to navigate within the menu and select the file you want to access, then press **OK**.
- 4 To create a playlist, highlight the track/file and press **SELECT**.
→ The selected tracks/files will appear on the right screen.
- To remove the track/file from the playlist, use **◀▶** keys to move to the right screen. Use **▲▼** keys to select the track/file, press **SELECT** once.
- 5 To stop playback, press **STOP ■** and remove the USB flash drive / USB memory card reader from the USB port.

TIPS: Some discs cannot be played on this recorder due to the configuration and characteristics of the disc, or due to the condition of recording and authoring software.

Additional Playback Features

Changing to another title/ chapter/track

When a disc contains more than one track, title or chapter, you can change to a different track, title or chapter as follows:

During playback,

- Press ►| (NEXT) to go to the next title/
chapter/track.
- Press ◀| (PREV) to return to the start of
the previous chapter/track.

Pausing playback and resume play

- 1 During playback, press **PAUSE LIVE TV ►||** to pause playback.
- 2 To resume normal playback, press **PAUSE LIVE TV ►||**.

Searching forward/backward

You can fast forward or fast reverse a disc at two, four, sixteen or thirty two times the normal playback speed.

- 1 During playback, press ◀◀ (fast reverse) or ▶▶ (fast forward) to start fast reverse or fast forward search. Press the same key repeatedly for various search speed options.
- 2 During disc playback, press **DISPLAY** twice to access the playback menu.
 - Use ▲▼ keys to highlight { **Trick Mode - Pause** } and press ► (RIGHT) to access the search speed options.
 - The sound will be muted.
- 3 To resume normal playback, press **PAUSE LIVE TV ►||**.

Zooming in

This option allows you to enlarge the picture on the screen and pan through the enlarged picture.

- 1 Press **ZOOM** on your remote control to activate zoom.
- 2 Use ◀▶▲▼ keys to pan through the zoomed picture.
- 3 To exit, press **ZOOM** repeatedly until the picture returns to the normal size.

TIPS: The operating features described here might not be possible for certain discs. Always refer to the instructions supplied with the discs.

Additional Playback Features (continued)

Using DISPLAY options

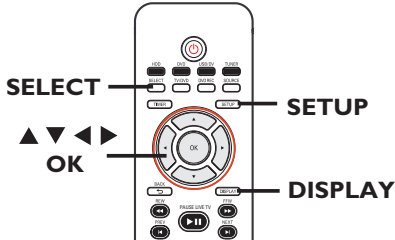

- 1 During disc playback, press **DISPLAY** twice on the remote control.
→ The playback menu appears on the TV.

DVD	
Mode	Normal
Trick mode	Play
Title	02/05
Chapter	01/22
Audio	01/02 - 0TH
Subtitle	Off
Angle	01/03
Title Time	00:22:03 - 00:27:24

- 2 Use ▲▼ keys to select the setting you want to adjust.
→ Instructions and explanation of the options are provided in the following pages.
- 3 To exit, press **DISPLAY**.

Selecting various repeat functions

You can select various repeat play or random play modes during playback.

- 1 During disc playback, press **DISPLAY** twice on the remote control.
→ The playback menu appears.
- 2 Use ▲▼ keys to select { **Mode** } and press **OK**.
- 3 Use ▲▼ keys to select one of the repeat options.
 - { **Normal** }
 - Select this to cancel the repeat mode and return to normal playback.
 - { **Repeat A-B** }
 - Select this to repeat the playback of a specific segment within a title/chapter/track. Press **OK** to mark the start and end of the segment you want to repeat.
 - { **Repeat Chapter** }
 - Select this to repeat playback of the current chapter (DVD, recordable DVDs only).
 - { **Repeat Track/Title** }
 - Select this to repeat playback of the current track/title.
 - { **Repeat Directory** }
 - Select this to repeat playback of the current folder/directory (MP3, JPEG, picture disc only).
 - { **Repeat Disc** }
 - Select this to repeat playback of the entire disc.
 - { **Shuffle** }
 - Select this to randomly playback all the tracks within the disc.
- 4 To cancel repeat playback, press **STOP ■**, then press **PAUSE LIVE TV ►II**. Alternatively, repeat steps 1 to 3 and select { **Normal** } and press **OK**.

TIPS: The operating features described here might not be possible for certain discs. Always refer to the instructions supplied with the discs.

Additional Playback Features (continued)

Creating a playlist

You can play the contents of the disc in the order you want by programming the tracks to be played.

- 1 Press **DISPLAY** twice on the remote control.
→ The playback menu appears.
- 2 Select { **Mode** } > { **Program** }.
→ The programme menu appears.

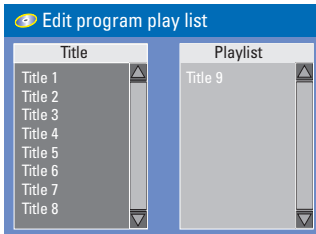

- 3 If the disc is recorded with Titles/Folders/Albums, press **OK** to access the tracks/files/chapters.
- Press **OK** at the highlighted track/file/chapter to start playback.

To programme your favourite track/ file/ chapter

- 4 Use **▲▼** keys to select the track/file/chapter to programme and press **SELECT** on the remote control.
→ The selected track/file/title will appear at the right screen.
→ The order on the right screen will be the order of programme playback.
- Use **◀▶** keys to toggle between the left and right screen.

To remove the programmed item from your selection

- 5 Press **▶** key to move to the right screen. Use **▲▼** keys to select the track/file/chapter to programme and press **SELECT** on the remote control.

To start programme play

- 6 Press **▶** key to move to the right screen and press **OK**.
→ Playback will start from the selected track/ file/ chapter according to the programmed sequence.

To exit programme play

- 7 Press **STOP** **■** to exit programme play.

Changing the audio soundtrack language

This operation works only on DVDs with multiple soundtrack language or VCDs with multiple audio channels.

This function can also be accessed by pressing the **AUDIO** key on the remote control.

- 1 Press **DISPLAY** twice on the remote control.
→ The playback menu appears.
- 2 Use **▲▼** keys to select { **Audio** } and press **▶** to access its options.
- 3 Use **▲▼** keys to select the audio language and press **OK** to confirm.
→ The languages may be numbered or abbreviated, such as "En" for English.
→ If the language selected is not available on the disc, the disc's default setting for language will be used instead.

Helpful Hint:

– Some DVDs allow soundtrack language changes only via the DVD disc menu. To access the disc menu, press **DVD** on the remote control.

TIPS: The operating features described here might not be possible for certain discs. Always refer to the instructions supplied with the discs.

Additional Playback Features (continued)

Changing subtitle language

This operation works only on DVDs with multiple subtitle languages, you can change the language you want while playing back the DVD.

This function can also be accessed by pressing the **SUBTITLE** key on the remote control.

- 1 Press **DISPLAY** twice on the remote control.
→ The playback menu appears.
- 2 Use **▲▼** keys to select { **Subtitle** } and press **▶** to enter the menu and find the different available options.
- 3 Use **▲▼** keys to select the language and press **OK** to confirm.
→ The languages may be numbered or abbreviated, such as "En" for English.
→ If the language selected is not available on the disc, the disc's default setting language will be used instead.

Helpful Hint:

– Some DVDs discs allow subtitle language changes only via the DVD disc menu. To access the disc menu, press DVD.

Switching camera angles

This option is only available with DVDs that contain sequences recorded from different camera angles. This allows you to view the picture from different angles.

This function can also be accessed by pressing the **ANGLE** key on the remote control.

- 1 Press **DISPLAY** twice on the remote control.
→ The playback menu appears.
- 2 Use **▲▼** keys to select { **Angle** } and press **▶** to enter its options.
→ The camera angles available for selection appears.
- 3 Use **▲▼** keys to select the camera angle you want to switch to, then press **OK** to confirm.

Title/ Chapter search

This option allows you to skip to a specific title/chapter on the current disc.

- 1 Press **DISPLAY** twice on the remote control.
→ The playback menu appears.
- 2 Use **▲▼** keys to select { **Title** } or { **Chapter** } and press **OK** to enter its options.
→ Use the **numeric keypad 0-9** to enter the title/chapter required.
→ Playback skips to the selected title/ chapter.

TIPS: The operating features described here might not be possible for certain discs. Always refer to the instructions supplied with the discs.

Edit Recordings - HDD

About HDD title edit menu

In the HDD title edit menu, you can change the title name, hide unwanted scenes, delete titles, split a title.

The edit options in the HDD title edit menu are:

{ Play Title }

- Select a title (recording) to play.

{ Delete Title }

(For unprotected and unlocked titles only)

- Delete the title (recording).

{ Divide Title }

- Divide the recording into two separate titles.

{ Edit Title }

- Hide the unwanted scene in the recording.

{ Rename }

- Change the name of a title (recording).

{ Lock/ Unlock }

- Lock or unlock a title (recording) to prevent/allow playback.

{ Protect/ Unprotect }

- Protect or unprotect a title (recording) to prevent/allow erasure or changes being made.

Accessing the HDD title edit menu

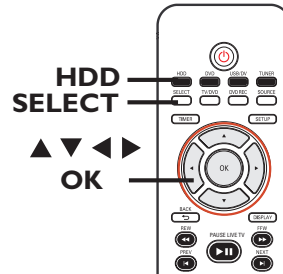

- 1 Press **HDD** on the remote control.
→ The HDD content menu appears.
- 2 Use **▲▼** keys to highlight a title (recording) and press **▶**.
→ The HDD title edit menu appears.

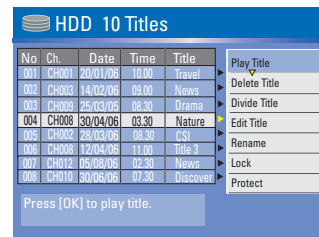

- If you have many HDD title recordings, use **◀** (PREV) or **▶** (NEXT) to view the previous/ next page of HDD titles for selection.
- 3 Use **▲▼** keys to access the different options and press **OK**.
→ Instructions and explanation of the options are provided in the following pages.
 - 4 To exit, press **◀** to go back to the HDD title menu screen.

Note: Any title/ recording which has been edited will be marked with an edited icon  next to the selected title's index picture.

TIPS: Press **◀** to go back to the previous menu.

Edit Recordings - HDD (continued)

Dividing a title

You can divide the current title into two new titles. Each of these titles is characterised by its own index picture.

Warning! Once a title is divided, the process cannot be reversed.

- 1 In HDD title edit mode, use ▲▼ keys to highlight { **Divide Title** } and press **OK**.
→ The edit title playback screen appears.
- 2 During playback, use ◀▶ keys to navigate through the title. Press **OK** to divide the title at the desired playback position.
→ A warning message will appear.
- 3 To confirm, select **OK** in the menu and press **OK**.
→ A new title will be shown in the HDD title menu.
- 4 To abort, select **CANCEL** and press **OK**.

Hiding unwanted scenes

You can choose to hide certain scenes from playback (e.g. skipping a commercial scene) or make it visible again.

- 1 In HDD title edit mode, use ▲▼ keys to highlight { **Edit Title** } and press **OK**.
→ The edit title playback screen appears.
- 2 During playback, press **PAUSE LIVE TV ▶||** and use ◀▶ keys to navigate through the title. Press **OK** to mark the beginning of a segment to hide.
- 3 Use ◀▶ keys to navigate through the title. Press **OK** again to mark the end of segment to hide.
- To hide more segments, repeat steps 2 to 3 for each segment you want to hide.

To unhide the scenes,

- 4 In HDD title edit mode, use ▲▼ keys to highlight { **Edit Title** } and press **OK**.
→ The edit title playback screen appears.
- 5 During playback, use ◀▶ keys to navigate through the title. Press **OK** at the beginning of the marked segment.
- 6 Press ▶ repeatedly until you reach the end of the marked segments and press **OK**.

Helpful Hints:

- All hidden scenes will be played back in HDD title edit mode.
- The { **Edit Title** } option is only available if the title is unlocked or unprotected.

TIPS: Press ◀ to go back to the previous menu.

Edit Recordings - HDD (continued)

Rename a title

The original title name is automatically generated by the recorder. You can change the disc name by following the steps below.

- 1 In HDD title edit mode, use ▲▼ keys to highlight { **Rename** } and press **OK**.
→ The keyboard screen appears.
- 2 Use ◀▶▲▼ keys to highlight a character on the keyboard and press **OK** to select.
→ The maximum input is up to 255 characters. However, only 12 characters will be displayed at any one time in the HDD title menu.
- You can use the following keys on the keyboard screen to edit your input:
 - BkSp** : to remove a character to the left of the cursor.
 - Space** : to create a space between characters.
 - Caps** : to toggle between upper and lower case characters .
 - Clear** : to clear the entry field completely.
 - Exit** : to exit the keyboard screen.
- 3 To confirm your entry, select **OK** on the keyboard and press **OK**.
→ The info panel is now updated.
- To exit, select **Exit** on the keyboard and press **OK**.

Lock/ Unlock a title

You can choose to lock a title to prevent any unauthorised playback of the recording.

If a title has been locked, the user will be prompted to enter a 4-digit password preset in the system setup menu. To set/reset this password, see the chapter "Setup Menu Options - PREFERENCES Settings – Change Password."

- In HDD title edit mode, use ▲▼ keys to highlight { **Lock** } and press **OK**.
→ The locked title will have a Lock icon  next to its index picture.
→ When the title is locked, the option in the HDD title edit menu will change to { **Unlock** }.

Protect/ Unprotect a title

You can choose to protect the title in order to prevent accidental loss of recordings.

- In HDD title edit mode, use ▲▼ keys to highlight { **Protect** } and press **OK**.
→ The protected title will have a Safe Box icon  next to its index picture.
→ When the title is protected, the option in the HDD title edit menu will change to { **Unprotect** }.

TIPS: Press ◀ to go back to the previous menu.

Edit Recordings - Recordable DVD

About disc editing menu

This recorder offers various disc edit options for various disc types. You can change the disc content and settings of a recordable DVD from the disc editing menu. The edited contents may not be available if you play the disc on another DVD player.

The displayed options in the disc editing menu may differ depending on the type of disc.

{ Play }

- Start playing from the beginning of the disc.

{ Rename Disc }

- Change the name of the disc.

{ Erase Disc } - DVD±RWs only

- Erase all the recordings in the disc.

{ Record New Title }

- Start recording from the last empty title in the disc.

{ Overwrite Disc } - DVD±RWs only

- Start a new recording from the beginning of the disc, all the recorded content will be overwritten.

{ Finalize Disc } - DVD±Rs only

- Finalise the disc to enable playback on other DVD players. Further recording and editing to the disc are not allowed. It is not possible to unfinalise the disc.

{ Make Compatible } - DVD±RWs only

- To ensure the edited changes remain when the disc is played back on another DVD player. (eg., hidden chapters to remain hidden).

{ Lock/Unlock Disc } - DVD±RWs only

- Lock or unlock a disc to prevent accidental erasure or changes being made.

Accessing disc editing menu

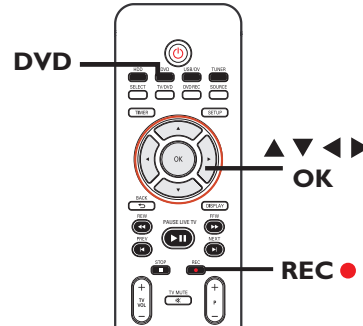

- 1 Insert a recordable DVD into the recorder. Press **DVD** on the remote control.
→ The Index Picture screen appears on the TV.
- 2 Select the first title on the disc, press and hold **▲** on the remote control.
→ The disc editing menu appears. Press **▶** to access the options. The available editing options may vary for DVD±R and DVD±RW discs.

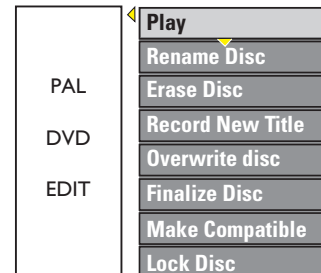

- 3 Use **▲▼** keys to access different options and **OK** to select.
→ Instructions and explanation of the options are provided in the following pages.
- 4 To exit, press **DVD** to go back to the disc Index Picture screen.

TIPS: No further recording and editing can be carried out on a finalised recordable DVD. Press **DVD** to return to the index picture screen.

Edit Recordings - Recordable DVD (continued)

Rename disc

The original disc name is generated automatically by the recorder. You can change the disc name by following the steps below.

- In disc editing menu, use ▲▼ keys to select { **Rename Disc** } and press **OK**.
→ The keyboard screen appears.
- Use ◀▶▲▼ keys to highlight a character on the keyboard and press **OK** to select.
→ The maximum input is up to 9 characters.
- You can use the following keys on the keyboard screen to edit your input:
 - BkSp** : to remove a character to the left of the cursor.
 - Space** : to create a space between characters.
 - Caps** : to toggle between upper and lower case characters .
 - Clear** : to clear the entry field completely.
 - Exit** : to exit the keyboard screen.
- To confirm your entry, select **OK** on the keyboard and press **OK**.
→ The info panel is now updated.
- To exit, select **Exit** on the keyboard and press **OK**.

Erase disc (DVD±RWs only)

This erases the content of the DVD±RW disc including those that was not recorded on this recorder. Once the existing content is erased, it can be used for recording.

- In disc editing menu, use ▲▼ keys to select { **Erase Disc** } and press **OK**.
→ A warning message will appear.
- Select **YES** in the menu to proceed or **NO** , to abort, then press **OK** to confirm.

Helpful Hint:

– To erase content that cannot be played back on this recorder, please use the option { **Delete Optical Disc** } under the setup menu.

Record a new title

This function allows you to start a new recording at the remaining empty space in the recordable DVD.

- In disc editing menu, use ▲▼ keys to select { **Record New Title** } and press **OK**.
- Select the source you want to record from and press **REC** ● to start recording.

Overwrite disc (DVD±RWs only)

This function allows you to start a new recording from the beginning of a DVD±RW regardless of the contents of the disc.

- In disc editing menu, use ▲▼ keys to select { **Overwrite Disc** } and press **OK**.
- Select the source you want to record from and press **REC** ● to start recording.

TIPS: No further recording and editing can be carried out on a finalised recordable DVD. Press **DVD** to return to the index picture screen.

Edit Recordings - Recordable DVD (continued)

Make compatible (DVD±RW only)

The edited DVD±RW may still display the original titles or hidden scenes when played back on other DVD players. This function ensures that the edited changes of the DVD±RW remain when played back on other players.

- In disc editing menu, use ▲▼ keys to select { **Make Compatible** } and press **OK** to confirm.

Helpful Hint:

– If the option { *Compatible* } is not available for selection, it means that the disc is already compatible.

Lock/Unlock disc (DVD±RWs only)

You can choose to protect the recordings on the DVD±RW disc in order to prevent accidental loss of recordings.

- 1 In disc editing menu, use ▲▼ keys to select { **Lock Disc** } and press **OK**.
→ The disc is locked for this DVD recorder only.
→ When the disc is locked, the option in the disc editing menu will change to { **Unlock Disc** }.
- 2 If you want to overwrite or edit on the protected disc, select { **Unlock Disc** }.

Playing your recordings on other DVD players (DVD±R only)

It is necessary to finalise a DVD±R disc before you can play it on any other DVD player. Otherwise, the disc will only playback on this recorder.

After a DVD±R disc has been finalised, no further recordings or editing can be made to it. Make sure you have completed all the recordings and editing before finalising the disc.

- 1 In disc editing menu, use ▲▼ keys to select { **Finalize Disc** } and press **OK**.
→ A warning message will appear.
- 2 Select in the menu and press **OK** to start the process.
→ Finalisation will take a few minutes.
Do not try to open the disc tray or turn the power off as this may render the disc unusable.
- 3 Select to abort.

TIPS: No further recording and editing can be carried out on a finalised recordable DVD. Press **DVD** to return to the index picture screen.

Edit Recordings - Recordable DVD (continued)

About DVD title editing

You can change the individual title information or delete a title (recording) on a recorded DVD disc. If the recordable DVD has been finalised, it cannot be edited.

The displayed options in the title editing menu may differ depending on the type of disc.

{ Play Title }

- Start playing a recording.

{ Edit Title }

- Access video editing menu.

{ Rename Title }

- Change the name of the recording.

{ Erase Title } - DVD±RWs only

- Delete the title (recording).

{ Overwrite Title } - DVD±RWs only

- Start a new recording and the existing title (recording) will be overwritten.

{ Overwrite Disc } - DVD±RWs only

- Overwrite from existing selected title onwards to the end of the disc.

{ Append Title }

- Insert a new recording to the last existing recording.

Accessing DVD title edit menu

- 1 Insert a recordable DVD into the recorder. Press **DVD** on the remote control.
 - The Index Picture screen appears on the TV.
- 2 During playback, press **DVD** to access the Index Picture screen.
 - Use ▲▼ keys to highlight a title (recording), and press ►.
 - The title editing menu appears.



- 3 Use ▲▼ keys to access different options and **OK** to select.
 - Instructions and explanation of the options are provided in the following pages.
- 4 To exit, press ◀.

Editing video

This feature allows access to the video editing menu. See the chapter “Edit Recordings – Recordable DVD - About video editing” for more information.

- In title editing menu, use ▲▼ keys to select { **Edit Title** } and press **OK**.
 - The video editing menu appears.
 - The recorder will play the selected title.

TIPS: No further recording and editing can be carried out on a finalised recordable DVD. Press ◀ to go back to the previous menu.

Edit Recordings - Recordable DVD (continued)

Rename title

The original title name is generated automatically by the recorder. You can give a new name to the title by following the steps below.

- In title editing menu, use ▲▼ keys to select { **Rename Title** } and press **OK**.
→ The keyboard screen appears.
- Use ◀▶ ▲▼ keys to highlight a character and press **OK** to select.
→ The maximum input is up to 9 characters.
- You can use the following keys on the keyboard screen to edit your input:
 - BkSp** : to remove a character to the left of the cursor.
 - Space** : to create a space between characters.
 - Caps** : to toggle between upper and lower case characters .
 - Clear** : to clear the entry field completely.
 - Exit** : to exit the keyboard screen.
- To confirm your entry, select **OK** on the keyboard and press **OK**.
→ The info panel is now updated.
- To exit, select **Exit** on the keyboard and press **OK**.

Erase title

You can delete a specific title (recording) from the disc.

- In title editing menu, use ▲▼ keys to select { **Erase Title** } and press **OK**.
→ A warning message will appear.
- Select **YES** in the menu to proceed or **NO** to abort, then press **OK** to confirm.

TIPS: No further recording and editing can be carried out on a finalised recordable DVD. Press ◀ to go back to the previous menu.

Overwrite title (DVD±RW only)

This function allows you to record a new title from the beginning of the current title in the DVD±RW disc.

- In title editing menu, use ▲▼ keys to select { **Overwrite Title** } and press **OK**.
- Select the source you want to record from and press **REC** ● to start recording.

Overwrite from the selected title

You can select to overwrite only the recordings from the selected title to the end of the disc.

- In title editing menu, use ▲▼ keys to select { **Overwrite Disc** } and press **OK** to delete.

Append recording

This function allows you to append recording to the last existing title.

Note: Under the { **Append Title** } option, it is not possible to select the mode of record quality when a recording is appended to an existing title on a DVD. The record quality will always be determined by the quality mode of the existing title.

- In title editing menu, use ▲▼ keys to select { **Append Title** } and press **OK**.
- Press **SOURCE** to select the input channel to append.
- Press **REC** ● to start append recording.
- To stop append recording, press **STOP** ■.

Edit Recordings - Recordable DVD (continued)

About video editing

After a recording has been made, this recorder allows you to edit the video content. You can add/delete chapter marker, hide unwanted scenes, change the picture in the index picture screen and split a title (recording) into two.

When you playback a recording in video edit mode, the entire recording will be played back including hidden scenes.

The edit functions available in the disc editing menu are:

{ Title }

– Select a specific title (recording) to play.

{ Chapter }

– Select a chapter within the selected title.

{ Chapter Marker }

– Insert a chapter marker in the recording or erase a chapter marker to combine two chapters.

{ Hide Chapter }

– Hide the unwanted scene in the recording.

{ Index Picture }

– Select a scene in the recording as the index picture screen.

{ Split Title } - DVD±RWs only

– Divide the recording into two separate titles.

Accessing video editing menu

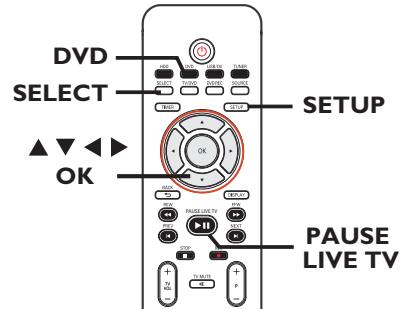

- 1 Insert a recordable DVD into the recorder. Press **DVD** on the remote control.
→ The Index Picture screen appears on the TV.
- 2 Use **▲▼** keys to highlight a title (recording), and press **▶** to access the menu.
→ The title editing menu appears.
- 3 Use **▲▼** keys to select { **Edit Title** } and press **OK**.
→ The edit mode menu appears.

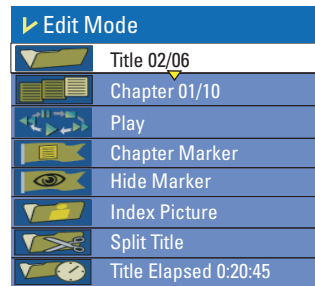

- 4 Use **▲▼** keys to access different options and press **OK** to select.
→ Instructions and explanation of the options are provided in the following pages.
- 5 To exit, press **DVD**.

TIPS: No further recording and editing can be carried out on a finalised recordable DVD.
Press **◀** to go back to the previous menu.

Edit Recordings - Recordable DVD (continued)

Selecting a title

It shows the current title and the total number of titles in the disc. It also allows you to select another title.

- 1 In edit mode, use ▲▼ keys to select  { **Title** } and press **OK**.
- 2 Use the **numeric keypad 0-9** to key in a title and press **OK**.
→ The recorder will play the selected title.

Selecting a chapter

It shows the current chapter and the total number of chapters in the title. It also allows you to select another chapter within the title.

- 1 In edit mode, use ▲▼ keys to select  { **Chapter** } and press **OK**.
- 2 Use the **numeric keypad 0-9** to key in the chapter and press **OK**.
→ The recorder will play the selected chapter.

Creating chapter markers

You can create a chapter by inserting a chapter marker at any point within a title during playback. This will allow you to access a specific point in the recording easily or set a chapter you wish to hide.

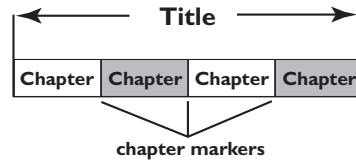

- 1 In edit mode, use ▲▼ keys to select  { **Chapter Marker** } and press **OK**.
- 2 Use ▲▼ keys to select one of the options and press **OK** to confirm.
 - { **Insert Marker** }
 - Select this to insert a new chapter marker at the current point of playback.
 - { **Delete Marker** }
 - Select this to delete the current chapter marker (it refers to the closest marker before the current point of playback).
 - { **Delete All Markers** }
 - Select this to delete all the chapter markers in the current title.

TIPS: No further recording and editing can be carried out on a finalised recordable DVD. Press ◀ to go back to the previous menu.

Edit Recordings - Recordable DVD (continued)

Hiding an unwanted chapter

You can choose to hide certain scenes from playback (e.g. skipping a commercial scene) or make it visible again.

- 1 Create a chapter marker at the scene you are going to hide. (See previous page on "Creating chapter markers").
- 2 Select the chapter you want to hide and start playback. (See previous page on "Selecting a chapter").
- 3 In edit mode, use ▲▼ keys to select  { **Hide Chapter** } and press **OK**.
→ The current chapter will be hidden.

To unhide a chapter

- 1 In edit mode, use ▲▼ keys to select  { **Unhide Chapter** } and press **OK**.
→ The video editing menu appears.
→ While in editing mode, the hidden chapter/chapters will play.
- 2 Wait for the chapter you want to unhide to occur or use ◀▶ keys on the remote control to make a fast search.
→ The current chapter will be visible during playback.

Helpful Hint:

– All the hidden chapters will be played back while in video editing mode.

Changing Index Picture

The index picture is the picture of the title you will see when the recorder loads up the Index menu. Normally, the first frame of a recording is shown as the title's index picture.

- 1 In edit mode, use ▲▼ keys to select  { **Index Picture** } and press **OK**.
→ The display will be in playback mode.
- 2 Use ◀▶ keys on the remote control to search for the scene to use, then press **OK** to confirm the current scene as the index picture for the title.
→ The new index picture will be shown in the title menu.

Splitting a title (DVD±RWs only)

You can divide the current title into two new titles. Each of these titles will be characterised by its own index picture.

Warning! Once a title is divided, the process cannot be reversed.

- In edit mode, use ▲▼ keys to select  { **Split Title** } and press **OK** to divide the title at the current playback position.
→ A new title will be shown at the Index Picture screen.

TIPS: No further recording and editing can be carried out on a finalised recordable DVD.
Press ◀ to go back to the previous menu.

Setup Menu Options

Accessing the Setup Menu

The setup menu provides various options for you to adjust the recorder to suit your preferences.

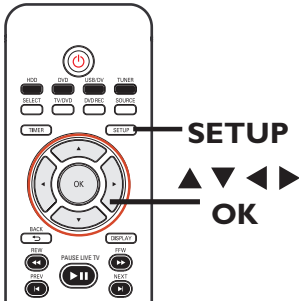

- 1 Press **SETUP** on the remote control.
→ The setup menu appears on TV.
- 2 Use **▲▼** keys to highlight a setup option and press **▶** to access.
- 3 Use **▲▼** keys to highlight the setting you wish to change and press **OK** to confirm and go back to the previous menu item.
→ Instructions and explanation of the options are provided in the following pages.
- 4 To exit, press **SETUP**.

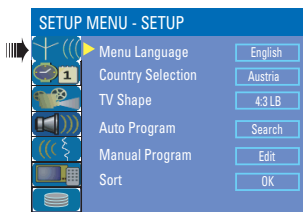

See facing page.

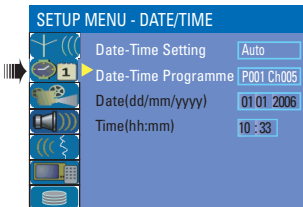

See this chapter "DATE/TIME Settings".

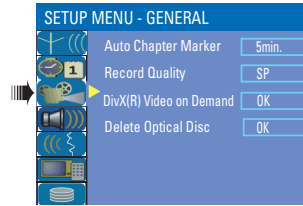

See the chapter "Recording" and "GENERAL Settings".

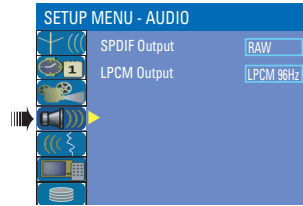

See this chapter "AUDIO Settings".



See this chapter "LANGUAGE Settings".

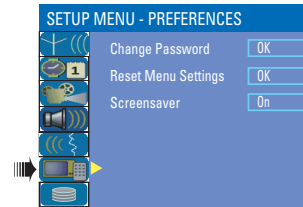

See this chapter "PREFERENCES Settings".

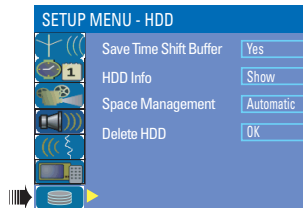

See this chapter "HDD Settings".

Setup Menu Options (continued)

SETUP settings (underlined options are the factory default settings)

Menu Language

Selects the menu language for this recorder on-screen display.

Country Selection

Select the country of your residence.

TV Shape

The picture shape can be adjusted to fit your TV.

Press **▶** to access this menu and use **▲▼** keys to select one of the options.

{ 4:3 LB } – For a 'wide screen' display with black bars on the top and bottom of the screen.



{ 4:3 PS } – For a full-height picture with sides trimmed.

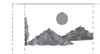

{ 16:9 WS } – For wide screen TV (frame ratio 16:9).



Auto Program

Start automatic TV channel programming. Press **OK** to start automatic TV channel programme search. See the chapter on "Setting your TV channel programmes".

Manual Program

Modify your preset TV channels.

- 1) Use **▲▼** keys to highlight { **Manual Program** } and press **→**. A warning message will appear. Select **OK** to proceed.
- 2) Use **▲▼** keys to select one of the options and press **▶**.

{ **Programme Number** } – Use **P + /** – to select by the programme number for modifying.

{ **Search Type** } – Select the mode to search for a programme channel, either by { **Frequency** } or { **Channel** }.

This option is available if you have selected { Search Type - Frequency },

{ **Frequency** } – Select this to adjust the frequency of the channel.

– Use **◀▶** keys to search for the next frequency or use the **numeric keypad 0-9** to change the frequency. Press **OK** on the remote control to confirm the setting.

This option is available if you have selected { Search Type - Channel },

{ **Channel** } – Select this to locate the programme number for fine-tuning.

– Use **◀▶** keys to search for the next channel or use the **numeric keypad 0-9** to enter the channel number. Press **OK** on the remote control to confirm the setting.

Manual Program	
Programme Number	P001 CH023
Search Type	Frequency
Frequency	058.98Mhz
Fine Tuning	+
Standard	PAL B/G
NICAM	On
Audio	Dual A
Decoder	Off
Skip	No
<input type="button" value="OK"/> <input type="button" value="CANCEL"/>	

Manual Program	
Programme Number	P001 CH023
Search Type	Channel
Channel	C-23
Fine Tuning	+
Standard	PAL B/G
NICAM	On
Audio	Dual A
Decoder	Off
Skip	No
<input type="button" value="OK"/> <input type="button" value="CANCEL"/>	

Setup Menu Options (continued)

SETUP settings

Manual Program

2) Use ▲▼ keys to select one of the options and press ►.

Manual Program	
Programme Number	P001 CH023
Search Type	Frequency
Frequency	058.8 Mhz
Fine Tuning	Standard
Standard	PAL B/G
NICAM	On
Audio	Dual A
Decoder	Off
Skip	No
<input type="button" value="OK"/> <input type="button" value="CANCEL"/>	

{ **Fine Tuning** }

- Select this to fine-tune the TV channel manually if the reception is poor.
- Use ◀▶ keys to fine-tune the frequency.

{ **Standard** }

- Select this to set the system that produces the least distortion of picture and sound. Press **OK** on the remote control to confirm the setting. (See chapter “TV System Guide” at the back of this manual for information).

{ **NICAM** }

- Select this to receive dual language broadcasts and to improve the sound quality of the TV channel.
- Use ▲▼ keys to select { **On** } or { **Off** }, then press **OK** on the remote control to confirm the setting.

Manual Program	
Programme Number	P001 CH023
Search Type	Channel
Channel	C-23
Fine Tuning	Standard
Standard	PAL B/G
NICAM	On
Audio	Dual A
Decoder	Off
Skip	No
<input type="button" value="OK"/> <input type="button" value="CANCEL"/>	

{ **Audio** }

- For dual language broadcasts, select this to switch between stereo (original) and the additional audio language.
- Use ▲▼ keys to select { **Dual A** } or { **Dual B** }, then press **OK** on the remote control to confirm the setting.

{ **Decoder** }

- If you have connected the recorder to an external decoder, select { **On** } and press **OK** to confirm. (for the channel from decoder).

{ **Skip** }

- Set the channel to be skipped. The skipped channels can only be accessed by pressing the corresponding number key on the remote control.
- Use ▲▼ keys to select { **Yes** } if you wish to skip the channel and press **OK** on the remote control to confirm the setting.

3) To confirm all the changes, select and press **OK** on the remote control to exit to the previous screen.

Setup Menu Options (continued)

SETUP settings

Sort

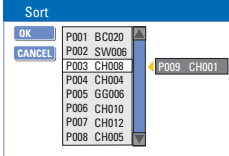

Sort your stored TV channels.

- 1) Use ▲▼ keys to highlight { **Sort** } and press ►.
→ The list of TV channel programmes appears.
 - 2) Use ▲▼ keys to highlight the channel you want to shift and press ►.
→ The selected channel will move to the right side of the screen.
 - 3) Use ▲▼ keys to shift the TV channel to the desired position. Select **OK** and press **OK** on the remote control.
→ The selected channel will be inserted before the current position.
- To cancel the change**, highlight **CANCEL** and press **OK**.
- 4) Repeat steps 2~3 until you have sorted all the TV channels you want.

DATE/ TIME settings (underlined options are the factory default settings)

Date -Time Setting

You can choose to activate/deactivate the automatic setting of date and time.

{ Auto }

– Select to activate automatic setting of date and time. The date and time setting will be updated according to the broadcast channel information of the selected preset Program Number under the { **Date-Time Programme** } setting.

{ Manual }

– Select this to manually set date and time.

Date-Time Programme

This option is available only if you have selected { Auto } for the { **Date - Time Setting** }.

Press ► to access the options. Use ▲▼ keys to select the programme channel for automatic date/ time settings. Press **OK** to confirm.

Date (dd/mm/yyyy)

Use ▲▼ keys to change the number and use ◀▶ keys to select different entry fields, then press **OK** to confirm.

Time (hh:mm)

Use ▲▼ keys to change the number and use ◀▶ keys to select different entry fields, then press **OK** to confirm.

Setup Menu Options (continued)

GENERAL settings

Auto Chapter Marker

Insert chapter markers within a title during recording. This lets you access to specific points on the recording. See the chapter on "Default Recording Settings".

Record Quality

Preset your preferred mode of recording quality. See the chapter on "Default Recording Settings".

DivX(R) Video on Demand

Philips provides you with the DivX® VOD (Video On Demand) registration code that allows you to rent and purchase videos using the DivX® VOD service. For more information, visit www.divx.com/vod.

- 1) Press ► to display the registration code.
- 2) Use the registration code to purchase or rent videos from DivX® VOD service at www.divx.com/vod. Follow the instructions and copy the video from your computer onto a CD-R/RW for playback on this recorder.

Delete Optical Disc

Erase all content on a DVD±RW disc, including those that were not recorded on this recorder. This option is only available in tuner mode.

Press ► to highlight **OK**.

→ A warning message will appear. Select **OK** to proceed or **CANCEL** to abort.

Setup Menu Options (continued)

AUDIO settings (underlined options are the factory default settings)

SPDIF Output

Press ► to access this menu and use ▲▼ keys to select one of the options.

- { RAW } – Select this if you have used the recorder's COAXIAL OUT socket to connect to a multichannel receiver.
- { LPCM } – Select this if you have used the recorder's COAXIAL OUT socket to connect to a stereo or audio/video system.

LPCM Output

This setting allows you to select between two levels:

- { LPCM 48 kHz } – Select this if the connected audio device is capable of processing digital signal input with sampling rates of 48 kHz. In addition, the disc you are playing back must be recorded in 48kHz LPCM format.
- { LPCM 96 kHz } – Select this if the connected audio device is capable of processing digital signal input with sampling rates of 96 kHz. In addition, the disc you are playing back must be recorded in 96kHz LPCM format.

LANGUAGE settings

Audio Language

Selects the preferred audio language for DVD playback.

Subtitle Language

Selects the preferred subtitle language for DVD playback.

Disc Menu Language

Selects the preferred disc menu language for DVD playback

Helpful Hints:

- If the selected audio/subtitle language is not available on the disc, the disc's default setting language will be used instead.
- For some DVDs, the subtitle/audio language can only be changed via the DVD disc menu.

Setup Menu Options (continued)

PREFERENCES settings (underlined options are the factory default settings)

Change Password

New Password

Enter password

Enter new password

Re-enter password

Change your password setting for locking/ unlocking a title recording.

- 1) Use ▲▼ keys to highlight { **Change Password** } and press **OK**.
→ You will be prompted to enter your four-digit pin code.
- 2) Use the numeric keypad 0-9 to enter your four-digit pin code.
→ When doing this for the first time, enter the default password '3308'.
→ If you forget your four-digit pin code, the default password is 3308.
- 3) Enter your new password and press ▼.
- 4) Re-enter your new password and select , then press **OK** on the remote control to confirm.

Reset Menu Settings

Restore all the settings of this recorder to factory settings.

Press ► to reset the menu settings of this recorder.

→ A warning message will appear. Select in the menu to proceed or to abort, then press **OK** to confirm.

Screensaver

The screen saver prevents damage to the TV screen by avoiding exposure to a static image for too long.

Press ► to access this menu and use ▲▼ keys to select one of the options.

- { On } – Select this if you wish to turn off the TV screen, after playback had been stopped or paused for more than 15 minutes.
- { Off } – Select this to disable the screen saver.

Setup Menu Options (continued)

HDD settings (underlined options are the factory default settings)

Save Time Shift Buffer

This option allows you to control the behaviour of the Time Shift Buffer.

- { Yes } – Retain the contents in the temporary HDD storage when you switch the tuner's TV channel or external video input source.
- { No } – Delete the contents in the temporary HDD storage.

HDD Info

Press **OK** to display information on:

- Hard disk size in MB (Megabytes).
- Used space in MB (Megabytes).
- Remaining space in MB (Megabytes).
- Number of titles stored on the HDD.

Space Management

This option determines how the recorder will respond when the HDD is full of recordings.

- { Automatic } – During recording, when the HDD is full, the recorder will proceed to overwrite any unprotected recordings in the HDD. The oldest unprotected recordings will be deleted first.
- { Manual } – During recording, when the HDD is full, recording will be stopped. A warning message { **The hard disk is full. Please erase some programmes to allow further recording.** } will appear on the screen.

Delete HDD

Erase all marked/ unmarked recordings on the HDD. This option is not available when recording to HDD is in progress.

Press **▶** to highlight **OK**.

→ A warning message will appear. Select **OK** to proceed or **CANCEL** to abort. Once complete, the recorder will switch to standby mode.

Software Upgrade

English

Installing the latest software

Periodically, Philips will release upgrades for the software that was initially installed in your recorder as the software is continuously refined for greater stability and compatibility of the recorder.

Caution! Power supply must not be interrupted during upgrade!

- Visit Philips' website at 'www.philips.com/support' to check for the availability of the latest software upgrade.

Note: When checking for the latest software upgrade, please also check for any accompanying instructions on installing the software.

Frequently Asked Questions

What kind of disc should I use for recording?

You can record on both DVD±R and DVD±RW discs. They are compatible with DVD-Video players and DVD-ROM drives in computers.

What is the capacity of a recordable DVD disc?

4.7GB, or equivalent to 6 CDs. You can store only one hour of recordings on a single disc at the highest quality (DVD standard) and about 8 hours recordings at the lowest quality (VHS standard).

What is the difference between DVD±R and DVD±RW?

DVD±Rs are "recordable" discs and DVD±RWs are "rewritable" discs. With a DVD±R disc, you can record multiple sessions on the same disc, but when the disc is full, you cannot record any more content on the disc. The DVD±RW disc allows you to record over the same disc repeatedly.

What is DV?

Using DV, also known as i.LINK, you can connect a DV-equipped camcorder to this recorder using a single DV cable for input and output of audio, video, data and control signals.

- This recorder is only compatible with DV-format (DVC-SD) camcorders. Digital satellite tuners and Digital VHS video recorders are not compatible.
- You cannot connect more than one DV camcorder at any one time to this recorder.
- You cannot control this recorder from external equipment connected via the DV IN socket.

Can I copy a VHS tape or DVD from an external player?

Yes, but only if the VHS tape or DVD is not copy-protected.

What are Titles and Chapters?

A DVD disc contains Titles and Chapters, which are similar to the Titles and Chapters of a book. A Title is often a complete movie and is broken down into Chapters, or individual scenes from the movies.

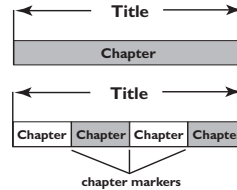

A programme is recorded as a single title, it may consist of one chapter or a few chapters within a title, depending on the recording settings.

How do I set up Titles and Chapters?

The recorder will automatically create a new Title each time you start a new recording.

- For DVD recordings, you can add chapters manually.
- For HDD recordings, you can preset chapters to be automatically inserted at 5-minutes intervals.

What does "finalizing" a disc do?

Finalizing a disc locks the disc so it can no longer be recorded, only required for DVD±Rs. It will then be compatible with virtually any DVD player. To close a disc without finalizing it, simply stop recording and eject the disc. You will still be able to record on the disc if there is capacity for more recordings.

How good is the quality of the recording?

There are seven modes of record quality levels to choose from, ranging from "HQ" (1 hour recording at high quality) to "SEP" (8 hours recording at VHS quality) on a recordable DVD. Choose the quality level that best suits your purpose and the length of material.

Record Quality	Hours of Recording that can be stored		
	160GB HDD	250GB HDD	DVD±R/ DVD±RW
HQ High Quality	34	50	1
SP Standard Play	68	100	2
SPP Standard Play Plus	85	130	2.5
LP Long Play	102	150	3
EP Extended Play	136	200	4
SLP Super Long Play	200	300	6
SEP Super Extended Play	270	400	8

Values are estimates only. Parts of the HDD storage capacity will be reserved for the operations of this recorder and time shifting.

Troubleshooting

WARNING

Under no circumstances should you try to repair the system yourself, as this will invalidate the warranty. Do not open the system as there is a risk of electric shock.

If a fault occurs, first check the points listed below before taking the system for repair. If you are unable to remedy a problem by following these hints, consult your dealer or Philips for help.

Problem (General)	Solution
No power	<ul style="list-style-type: none"> – Press STANDBY-ON button on the front of the recorder to switch on the system. – Make sure the AC outlet has power.
The recorder does not respond.	<ul style="list-style-type: none"> – There is a technical problem. Disconnect the recorder from the power outlet for 30 seconds, then reconnect and switch on the recorder again.
Remote control does not work.	<ul style="list-style-type: none"> – Aim the remote control directly at the IR sensor on the front of the recorder (not towards TV). – Remove any obstacles between the recorder and remote control. – Batteries are weak, replace the batteries.
No picture.	<ul style="list-style-type: none"> – Switch on your TV and set to the correct Video In channel for the recorder. You may go to Channel 1 on your TV, then press the channel down key on your TV's remote control until you see the TV programme. – Check the video connection between the recorder and the TV.
No sound.	<ul style="list-style-type: none"> – Check the recorder audio connections. Read chapter "Step 1 – Basic Recorder Connections - Connecting the audio cables" for details. – Set the option for Digital audio output correctly, based on the device you have connected to the recorder. Read chapter "Setup Menu Options - AUDIO settings" for details.
No TV signal received from the recorder.	<ul style="list-style-type: none"> – Check your antenna or cable TV signal. – Install the TV channel. Read chapter "Installation and Setup - Setting your TV channel programmes" for details.
The message 'This will clear the time shift buffer' appears.	<ul style="list-style-type: none"> – The requested action requires that the time shift buffer (temporary HDD storage) to be cleared. All contents that were not marked for recording will be deleted.
There is a power failure during the formatting of the recorder's HDD.	<ul style="list-style-type: none"> – Reformat the HDD again. – If the problem persists, please contact Philips for help.

Troubleshooting (continued)

Problem (Playback)	Solution
<p>Disc will not play.</p>	<ul style="list-style-type: none"> - Insert the disc with the label facing up. - Wrong region code. The DVD must be coded for ALL regions or Region 2 in order to play on this recorder. - There is no recording on the disc or it is not a supported type of disc. Read chapter "Playback from Disc - Playable discs" for details. - Make sure the disc is not scratched or warped. Clean the disc or replace a new one. - Check if the disc is defective by trying another disc.
<p>The picture is distorted or black and white during playback.</p>	<ul style="list-style-type: none"> - The disc does not match with the TV colour system standard (PAL/NTSC). - The disc is dirty, clean the disc. - Sometimes a small amount of picture distortion may appear. This is not a malfunction.
<p>There is picture or sound interference with the TV reception.</p>	<ul style="list-style-type: none"> - Have your antenna or cable TV signal checked. - Fine-tune your TV channel. Read chapter "Step 3: Installation and Setup - Setting your TV channel programmes" for details.
<p>Distorted sound coming from a connected hi-fi system or amplifier.</p>	<ul style="list-style-type: none"> - Do not connect any cables from the recorder to the 'Phono' input of your amplifier. - If you are playing a DTS CD, you have to connect the COAXIAL socket of this recorder to a Hi-Fi system or amplifier.
<p>The message 'UNKNOWN DISC' appears.</p>	<ul style="list-style-type: none"> - This message may appear if you insert a disc that may have encountered one of the following: <ul style="list-style-type: none"> - Error during recording: The title may be missing. - Error while changing the title/index picture. The original title/index picture may be visible. - Error while finalizing or the disc has not been finalised.
<p>AVI file does not play.</p>	<ul style="list-style-type: none"> - The AVI file you are trying to playback is not a DivX file.

Troubleshooting (continued)

English

Problem (Recording)	Solution
<p>Recordings are not occurring as scheduled. New recordings cannot be made.</p>	<ul style="list-style-type: none"> – The TV channel you want to record is not stored. Or, you may have selected the wrong programme number. Check the TV channels stored. – You have to reset the timer recording after adjusting the clock setting. – You cannot use the recorder to duplicate copy-protected materials (DVDs or videotapes) onto a recordable DVD. – The hard disk could be full. Delete some titles to create space for new recordings.
<p>The wrong TV channel was decoded (recorded) after you programmed a recording using the SHOWVIEW® /VIDEO Plus+ system.</p>	<ol style="list-style-type: none"> 1) Enter the SHOWVIEW®/ PlusCode programming number of the desired TV channel. 2) Press OK to confirm. 3) Check the channel number in the {Program #} input field. If this does not correspond to the desired TV channel, select this entry field and change the channel number. 4) Press OK to confirm.
<p>The recorded DVD cannot be played back on another DVD player.</p>	<ul style="list-style-type: none"> – If a recording is too short, it is possible that a DVD player/recorder cannot detect it. Please observe the following 'minimum recording times'. Mode of record quality: {High Quality - HQ} – 5 minutes, {Standard Play - SP} – 10 minutes, {Standard Play Plus - SPP} – 13 minutes, {Long Play - LP} – 15 minutes, {Extended Play - EP} – 20 minutes, {Super Long Play - SLP} – 30 minutes, {Super Extended Play - SEP} – 30 minutes. – You have to finalise the DVD±R. Refer to chapter "Playing your recordings on other DVD players" for details.
<p>Picture is fuzzy and brightness varies when copying DVD Video discs or prerecorded video cassettes.</p>	<ul style="list-style-type: none"> – This happens if you try to copy DVDs or video cassettes that have been copy-protected. Even though the picture on the TV is fine, but the recording on the recordable DVD is faulty. This interference is unavoidable with copy-protected DVDs or video cassettes. – The recordable DVD has a limited recording lifetime, please change a new disc for recording.

Troubleshooting (continued)

Problem (Recording)	Solution
<p>There is a power failure during the copying of files to a recordable DVD.</p>	<ul style="list-style-type: none"> – The titles that were previously recorded will be deleted and the space used for recording cannot be re-used. The disc can be used as a normal blank disc. You have to re-copy the files to the disc again.
<p>During recording from the time shift buffer, it is not possible to start or stop a recording.</p>	<ul style="list-style-type: none"> – Parts of the signal may be copy-protected by the broadcaster. This portion of the time shift video bar will be shown in a different colour. You can only start or stop a recording if the selected portion does not contain any copyright content. – Use ◀▶ keys or ◀◀ ▶▶ keys to navigate to a non-protected portion and press REC to start a recording. To end a recording, press STOP. – Press SELECT to clear a recording at any time.
<p>Archiving does not end.</p>	<ul style="list-style-type: none"> – There is a technical problem. Disconnect the recorder from the power outlet for 30 seconds, then reconnect and switch on the recorder again.

Specifications

Video Recording

- Recording System: PAL
- Compression formats: MPEG2
- Modes of Record Quality:
 - High Quality : HQ
 - Standard Play : SP
 - Standard Play Plus : SPP
 - Long Play : LP
 - Extended Play : EP
 - Super Long Play : SLP
 - Super Extended Play : SEP
- Recording enhancements:
 - Auto Chapter Marker Insertion, Divide Title, Erase, Manual Chapter Marking, One Touch Record
- Audio compression: Dolby Digital

Video Playback

- Disc Playback Media: CD, CD-R/CD-RW, DVD, DVD-Video, DVD+R/+RW, DVD+R DL, DVD-R/-RW, MP3-CD, Video CD, SVCD
- Compression formats: MPEG2, MPEG1, DivX
- Video disc playback system: PAL, NTSC

Audio Playback

- Disc Playback Media: MP3-CD, CD, CD-R/CD-RW
- Compression formats: Dolby Digital, DTS, MP3, PCM,
- MP3 bit rates: 32 - 256 kbps

Still Picture Playback

- Disc Playback Media: Picture CD
- Picture compression format: JPEG
- Picture enhancement: Rotate, Zoom, Slideshow

TV systems

- Playback: PAL
- Recording: PAL/NTSC
- Internal tuner: PAL/SECAM

Video Performance

- D/A Converter 10 bit, 54 MHz
- A/D Converter 10 bit, 27 MHz

Audio Performance

- DA Converter 24 bit, 192 kHz
- AD Converter 24 bit, 96 kHz
- Signal / Noise (1kHz) 100 dB
- Dynamic range (1kHz) 95 dB
- Crosstalk (1kHz) 105 dB

Tuner/Reception/ Transmission

- TV System: PAL, SECAM
- Aerial input: 75 ohm coaxial (IEC75)

Storage Media

- Recording :
 - DVD+R/+RW, DVD-R/-RW
- Hard Disk Capacity:
 - DVDR3450H/ DVDR3452H : 160GB
 - DVDR3460H/ DVDR3465H : 250GB
- HDD recording enhancements:
 - Instant Replay, Time Shift Buffer
- Extra Hard Disk Technology:
 - Pause Live TV, Simultaneous Record and Playback, Direct Record to DVD
- HDD to DVD archiving: high speed (direct copy)

Connectivity

- Rear Connections
 - SCART 1 (CVBS/RGB out)
 - SCART 2 (CVBS/RGB in)
 - S-video out
 - Video out (CVBS)
 - Analogue audio left/right out
 - Digital audio out (coaxial)
 - RF antenna in
 - RF TV out
 - Mains
- Front Connections
 - i.LINK DV in (IEEE 1394 4-pin)
 - S-Video in
 - Video (CVBS) in
 - Analogue audio left/right in
 - USB in (for DVDR3460H/ DVDR3465H)

Timer Recording

- Programmable events: 8
- Repeat modes: Once, Daily, Weekly, Mon-Fri, Mon-Sat, Weekend
- Enhancement: Manual Timer, SHOWVIEW®/VIDEO Plus+®

Convenience

- Direct record to optical disc

Power

- Power Supply: 110V~240V, 50~60 Hz
- Power Consumption: 28 W
- Standby power consumption: < 3.0 W

Dimensions

- Set dimension (W x H x D) : 435 x 43 x 322 mm
- Set Weight : 4.3 kg

Analogue: Sound that has not been turned into numbers. Analogue sound varies, while digital sound has specific numerical values. These sockets send audio through two channels, the left and right.

Aspect ratio: The ratio of vertical and horizontal sizes of a displayed image. The horizontal vs. vertical ratio of conventional TVs is 4:3, and that of widescreen is 16:9.

AUDIO OUT sockets: Red and white sockets on the back of the system that send audio to another system (TV, Stereo, etc).

Chapter: Sections of a picture or a music piece on a DVD that are smaller than titles. A title is composed of several chapters. Each chapter is assigned a chapter number enabling you to locate the chapter you want.

Digital: Sound that has been converted into numerical values. Digital sound is available when you use the DIGITAL AUDIO OUT COAXIAL. These sockets send audio through multiple channels, instead of just two channels as analogue does.

Disc menu: A screen display prepared for allowing selection of images, sounds, subtitles, multi-angles, etc recorded on a DVD.

DivX 3.11/4.x/5.x/6: The DivX code is a patent-pending, MPEG-4 based video compression technology, developed by DivX Inc., that can shrink digital video to sizes small enough to be transported over the internet, while maintaining high visual quality.

Dolby Digital: A surround sound system developed by Dolby Laboratories containing up to six channels of digital audio (front left and right, surround left and right, centre and subwoofer).

DTS: Digital Theatre Systems. This is a surround sound system, but it is different from Dolby Digital. The formats were developed by different companies.

Index Picture Screen: A screen that gives an overview of a DVD±RW or DVD±R. An Index Picture represents each recording.

JPEG: A very common digital still picture format. A still-picture data compression system proposed by the Joint Photographic Expert Group, which features small decrease in image quality in spite of its high compression ratio.

MP3: A file format with a sound data compression system. "MP3" is the abbreviation of Motion Picture Experts Group 1 (or MPEG-1) Audio Layer 3. By using the MP3 format, one CD-R or CD-RW can contain about 10 times more data than a regular CD.

MPEG: Motion Picture Experts Group. A collection of compression systems for digital audio and video.

Multichannel: DVDs are formatted to have each sound track constitute one sound field. Multichannel refers to a structure of sound tracks having three or more channels.

PBC: Playback Control. Refers to the signal recorded on video CDs or SVCDs for controlling playback. By using menu screens recorded on a Video CD or SVCD that supports PBC, you can enjoy interactive playback and searching.

PCM: Pulse Code Modulation. A digital audio encoding system.

Region code: A system allowing discs to be played only in the region designated. This unit will only play discs that have compatible region codes. You can find the region code of your unit by looking on the product label. Some discs are compatible with more than one region (or ALL regions).

S-Video: Produces a clear picture by sending separate signals for the luminance and the colour. You can use S-Video only if your TV has an S-Video In socket.

Surround: A system for creating realistic three dimensional sound fields full of realism by arranging multiple speakers around the listener.

Title: The longest section of a movie or music feature on DVD. Each title is assigned a title number, enabling you to locate the title you want.

VIDEO OUT socket: Yellow socket on the back of the DVD system that sends the DVD picture video to a TV.

Display panel symbols /messages

The following symbols/messages may appear on your recorder display:

- 00:00
Multifunction display/ text line
 - Title/track number
 - Total/elapsed/remaining title/track time
 - Disc/title name
 - Additional information regarding the disc
 - TV channel number or source of video
 - Clock (This is displayed in Standby mode).
 - TV programme title
- ⌚ TIMER
A timer recording has been programmed or is active.
- BLANK
No recordings on the disc.
- CLOSING
Disc tray is closing.
- EMPTY
No recordings in the hard disk drive.
- MENU
The system setup menu, disc menu, or title menu display is on.
- HDDMENU
The hard disk menu display is on.
- NO DISC
No disc has been inserted. If a disc has been inserted, then it is possible that the disc cannot be read.
- OPEN
Disc tray is opened or opening.
- READING
Disc is being recognised by the recorder.
- PHILIPS
The recorder has been turned on.
- SCANXXX
Please wait until this message disappears. The recorder is busy processing an operation. XXX indicates the number of found channels.
- TV/LOOP
The video input source is from your connected external device.
- Y_CHXXX
In time shift mode, where XXX indicates the input video source or channel number of tuner input.
- UPDATE
Please wait until the message disappears. Data is being written to the disc.

TV System Guide

English

COUNTRY	VHF	UHF	DVD REGIONS
AFGHANISTAN	PAL/SECAM B		5
ALBANIA	PAL B	PAL G	2
ALGERIA	PAL B	PAL G	5
ANGOLA	PAL I		5
ARGENTINA	PAL N	PAL N	4
AUSTRALIA	PAL B	PAL H	4
AUSTRIA	PAL B	PAL G	2
AZORES	PAL B		
BAHAMAS	NTSC M		4
BAHRAIN	PAL B	PAL G	2
BANGLADESH	PAL B		5
BARBADOS	NTSC M		4
BELGIUM	PAL B	PAL H	2
BERMUDA	NTSC M		
BOLIVIA	NTSC M	NTSC M	4
BOTSWANA	PAL I		5
BRAZIL	PAL M	PAL M	4
BRUNEI	PAL B	PAL B	
BULGARIA	SECAM D	SECAM K	2
BURKINA FASO	SECAM K1		5
BURMA	NTSC M		
BURUNDI	SECAM K1		5
CAMBODIA	NTSC M		3
CAMEROON	PAL B	PAL G	5
CANADA	NTSC M	NTSC M	1
CANARY ISLANDS	PAL B		2
CHAD	SECAM K1		5
CHILE	NTSC M	NTSC M	4
CHINA	PAL D		6
COLOMBIA	NTSC M	NTSC M	4
COSTA RICA	NTSC M	NTSC M	4
CROATIA	PAL B	PAL G	2
CUBA	NTSC M	NTSC M	4
CYPRUS	PAL B	PAL G	
CZECH REPUBLIC	PAL D	PAL K	2
DAHOMEY	SECAM K1		
DENMARK	PAL B	PAL G	2
DJIBOUTI	SECAM B	SECAM G	5
DOMINICAN REP	NTSC M	NTSC M	4
ECUADOR	NTSC M	NTSC M	4
EGYPT	SECAM B/PAL B	SECAM G/PAL G	2
EL SALVADOR	NTSC M	NTSC M	4
EQUAT. GUINEA	PAL B		5
ESTONIA	PAL B (was SECAM)	PAL D	5
ETHIOPIA	PAL B	PAL G	5
FIJI	PAL B		
FINLAND	PAL B	PAL G	2
FRANCE	SECAM L	SECAM L	2
FRENCH POLYNESIA	SECAM K1		
GABON	SECAM K1		5
GAMBIA	PAL I		5
GERMANY	PAL B	PAL G	2
GHANA	PAL B	PAL G	5
GIBRALTAR	PAL B	PAL H	2
GREECE	PAL B (was SECAM)	PAL G	2
GREENLAND	NTSC/PAL B		2
GUADELOUPE	SECAM K1		
GUAM	NTSC M		1
GUATEMALA	NTSC M	NTSC M	4
GUINEA	PAL K		5
GUYANA (FRENCH)	SECAM K1		4
HONDURAS	NTSC M	NTSC M	4

TV System Guide

English

COUNTRY	VHF	UHF	DVD REGIONS
LIBYA	SECAM B	SECAM G	5
LITHUANIA	PAL D (was SECAM)	PAL K	5
LUXEMBOURG	PAL B/SECAM L	PAL G/SEC L	2
MADAGASCAR	SECAM K1		5
MADEIRA	PAL B		
MALAGASY	SECAM K1		
MALAWI	PAL B	PAL G	5
MALAYSIA	PAL B		3
MALI	SECAM K1		5
MALTA	PAL B	PAL H	2
MARTINIQUE	SECAM K1		
MAURITANIA	SECAM B		5
MAURITIUS	SECAM B		5
MEXICO	NTSC M	NTSC M	4
MONACO	SECAM L		2
MONGOLIA	SECAM D		5
MOROCCO	SECAM B		5
MOZAMBIQUE	PAL B		5
NAMIBIA	PAL I		5
NEPAL	PAL B		
NETHERLANDS	PAL B	PAL G	2
NETH. ANTILLES	NTSC M	NTSC M	
NEW CALEDONIA	SECAM K1		
NEW GUINEA	PAL B	PAL G	4
NEW ZEALAND	PAL B	PAL G	4
NICARAGUA	NTSC M	NTSC M	4
NIGER	SECAM K1		5
NIGERIA	PAL B	PAL G	5
NORWAY	PAL B	PAL G	2
OMAN	PAL B	PAL G	2
PAKISTAN	PAL B		5
PANAMA	NTSC M	NTSC M	4
PARAGUAY	PAL N	PAL N	4
PERU	NTSC M	NTSC M	4
PHILIPPINES	NTSC M	NTSC M	3
POLAND	PAL D	PAL K	2
PORTUGAL	PAL B	PAL G (was SECAM D)	2
PUERTO RICO	NTSC M	NTSC M	1
QATAR	PAL B		2
REUNION	SECAM K1		
RUMANIA	PAL D	PAL K	2
RUSSIA	SECAM D	SECAM K	5
RWANDA	SECAM K1		5
SABAH/SAWARA	PAL B		
ST. KITTS	NTSC M	NTSC M	
SAMOA (US)	NTSC M		1
SAUDI ARABIA	SECAM-B/PAL-B	SECAM G	2
SENEGAL	PAL		5
SEYCHELLES	PAL B	PAL G	5
SIERRA LEONE	PAL B	PAL G	5
SINGAPORE	PAL B	PAL G	
SLOVAK REPUBLIC	PAL	PAL	2
SOMALIA	PAL B	PAL G	5
SOUTH AFRICA	PAL I	PAL I	2
SPAIN	PAL B	PAL G	2
SRI LANKA	PAL B		5
SUDAN	PAL B	PAL G	5
SURINAM	NTSC M	NTSC M	4
SWAZILAND	PAL B	PAL G	
SWEDEN	PAL B	PAL G	2
SWITZERLAND	PAL B	PAL G	2
SYRIA	SECAM B		2

English

Meet Philips at the Internet
www.philips.com
<http://www.philips.com/support>



Be responsible
Respect copyrights

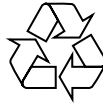

DVDR3450H
DVDR3452H
DVDR3460H
DVDR3465H

**CLASS 1
LASER PRODUCT**

3139 245 24502



Sgp-0722/05/31-I