

VMMK-3413

25 - 45 GHz Directional Detector in SMT Package



Data Sheet



Lead (Pb) Free
RoHS 6 fully
compliant



Description

The VMMK-3413 is a small and easy-to-use, broadband, directional detector operating in various frequency bands from 25 to 45 GHz with typical insertion loss of 0.8 dB. It is housed in the Avago Technologies' industry-leading and revolutionary sub-miniature chip scale package (GaAsCap wafer scale leadless package) which is small and ultra thin yet can be handled and placed with standard 0402 pick and place assembly equipment. The VMMK-3413 provides a wide detecting power level from -5 to +30 dBm with excellent input and output return losses. A typical of 10 dB directivity is provided, and the detector requires only 1.5 V DC biasing with small current drawn of 0.16 mA.

WLP0402, 1 mm x 0.5 mm x 0.25 mm

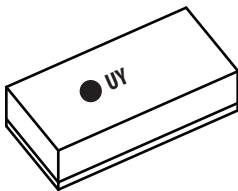

Pin Connections (Top View)

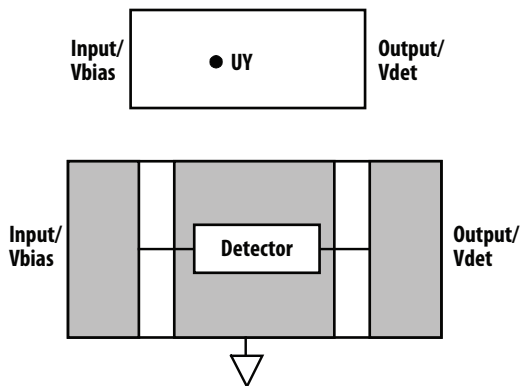

Note:
"U" = Device Code
"Y" = Month Code

Features

- 1 x 0.5 mm surface mount package
- Ultrathin (0.25 mm)
- Wide frequency range: 25 to 45 GHz
- Wide dynamic range
- Low Insertion loss
- Directivity: 10 dB typ.
- In and output match: 50 ohm

Specifications (35 GHz, Vb = 1.5 V, Zin = Zout = 50 Ω)

- Bias Current: 0.16 mA typical
- Insertion Loss: 0.8 dB
- Detector output offset voltage: 63 mV typical
- Detector Output voltage at +20 dBm: 674 mV typical

Applications

- Point-to-Point Radio
- Monitoring Power Amplifier Output Power
- Power Control Loop Detector



Attention: Observe precautions for handling electrostatic sensitive devices.
ESD Machine Model = 70 V
ESD Human Body Model = 350 V
Refer to Avago Application Note A004R:
Electrostatic Discharge, Damage and Control.

Electrical Specifications

Table 1. Absolute Maximum Rating ⁽¹⁾

Sym	Parameters/Condition	Unit	Absolute Max
Vbias	Bias Voltage (RF Input)	V	2
Ibias	Bias Current	mA	1
P _{in, max}	CW RF Input Power (RF Input) ⁽²⁾	dBm	+31
Tch	Max Channel Temperature	°C	+150

Notes

1. Operation of this device above any one of these parameters may cause permanent damage
2. With the DC (typical bias) and RF applied to the device at board temperature, T_b = 25° C

Table 2. DC and RF Specifications

T_A = 25° C, Freq = 35 GHz, V_{bias} = 1.5 V, Z_{in} = Z_{out} = 50 Ω unless otherwise specified

Symbol	Parameters / Condition	Unit	Min	Typical	Max
Ibias ⁽¹⁾	Bias Current	mA	0.1	0.16	0.23
I.L. ⁽¹⁾	Insertion Loss at 25 GHz at 35 GHz at 45 GHz	dB		0.5 0.8 1.1	
IRL ⁽¹⁾	Input Return Loss	dB		20	
ORL ⁽¹⁾	Output Return Loss	dB		17	
Dir ⁽²⁾	Directivity at 25 GHz at 35 GHz at 45 GHz	dB		10 18 7	
Voffset ^(1,3)	Detector Output Offset Voltage	mV	50	63	80
Vdet ⁽⁴⁾	Detector Output Voltage at +12 dBm	mV	550	674	790

Notes

1. Measured data obtained from wafer-probing, losses from measurement system de-embedded from final data, V_{bias} = 1.5 V applied through a broadband bias tee.
2. Measured by reversing the detector and applying RF power to the output port. Directivity is defined as the difference in dB between the power applied in the forward direction and the power required in the reverse direction to produce the same V_{det} voltage.
3. Voffset is measured with RF input power turned off.
4. Vdet is measured with +12 dBm RF input power at 35 GHz.

Product Consistency Distribution Charts at 35 GHz, Vbias = 1.5 V

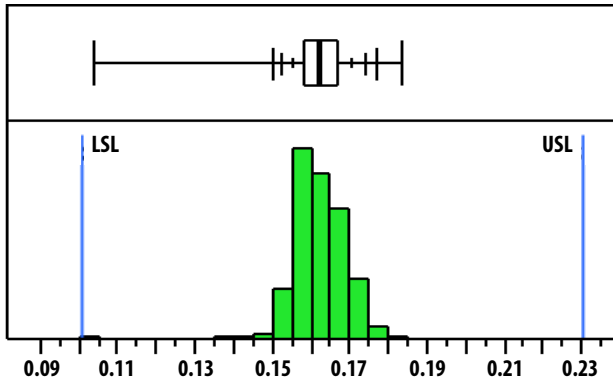

Ibias: Mean = 0.16 mA, LSL = 0.1 mA, USL = 0.23 mA

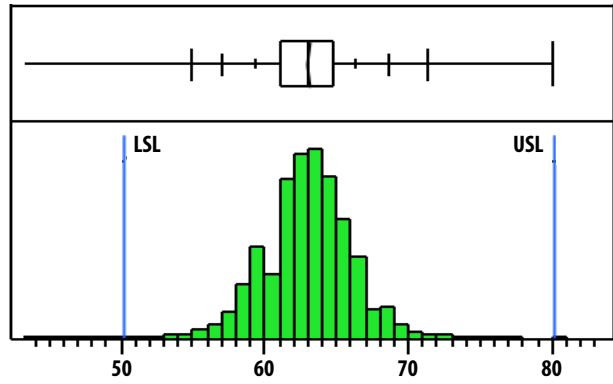

Voffset: Mean = 63 mV, LSL = 50 mV, USL = 80 mV

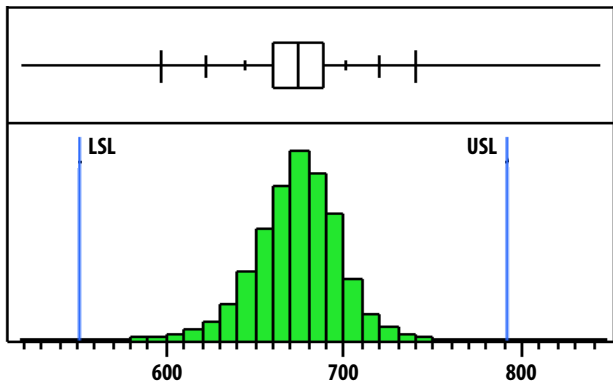

Vdet_On @ Pin = +12 dBm: Mean = 674 mV, LSL = 550 mV, USL = 790 mV

Notes:
 Distribution data sample sized is based on at least 57 Kpcs taken from MPV lots.
 Future wafers allocated to this product may have nominal values anywhere between the upper and lower limits.

VMMK-3413 Typical Performance

S-parameter data obtained using 300 μm G-S-G probe substrate; bias was brought in via broadband bias tees. Power vs. Vdet data obtained using CPW PCB (Fig. 8). Losses calibrated out to the package reference plane. ($T_A = 25^\circ\text{C}$, $V_{\text{bias}} = 1.5\text{ V}$, $I_{\text{bias}} = 0.16\text{ mA}$, $Z_{\text{in}} = Z_{\text{out}} = 50\ \Omega$ unless otherwise specified)

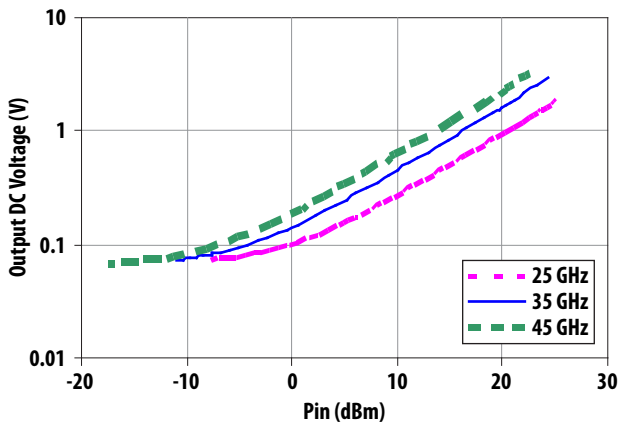

Figure 1. Vdet vs. Input Power

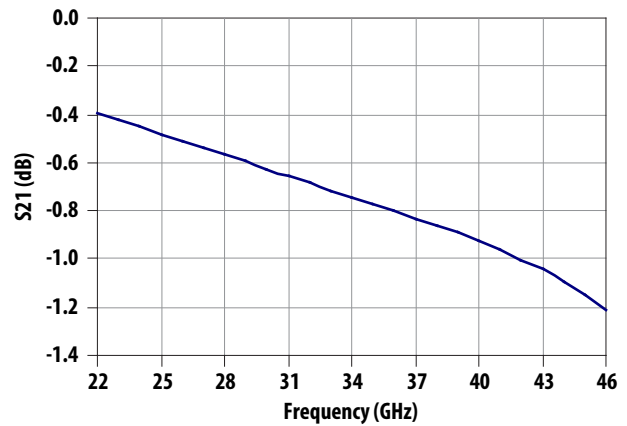

Figure 2. Insertion Loss vs. Frequency

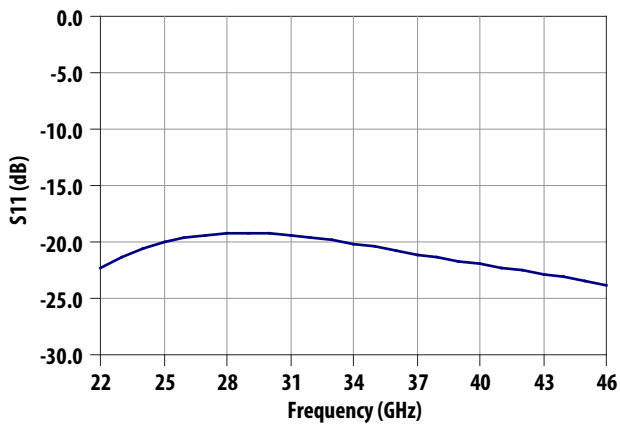

Figure 3. Input Return Loss

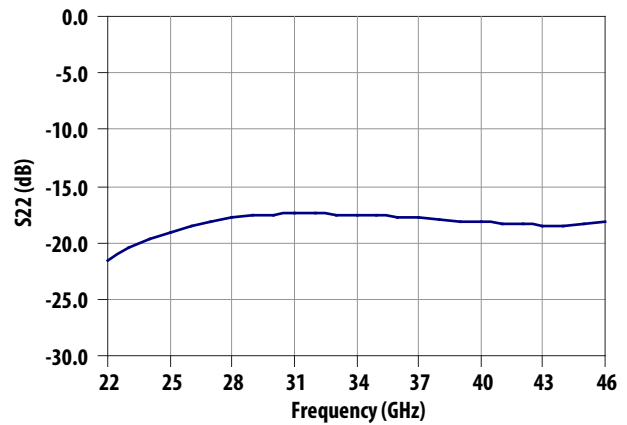

Figure 4. Output Return Loss

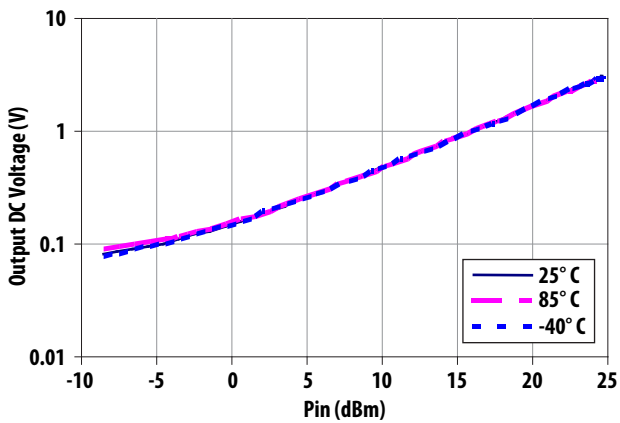

Figure 5. Pin vs. Vdet Over Temperature at 42 GHz

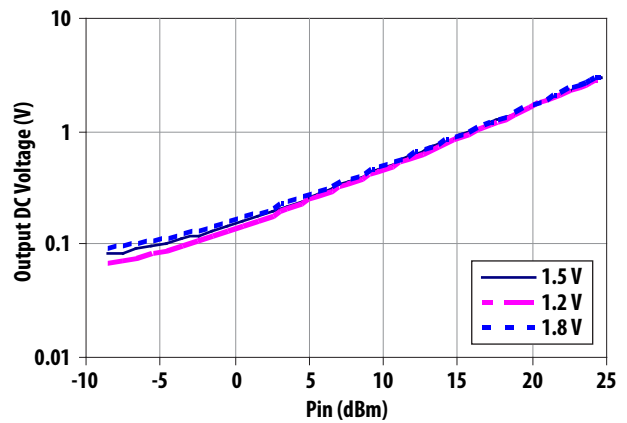

Figure 6. Pin vs. Vdet Over Vbias at 42 GHz

Typical Scattering Parameters

Data obtained with 300 μm G-S-G probing on 0.016 inch thick PCB substrate, broadband bias tees, losses calibrated out to the package reference plane. $T_A = 25^\circ\text{C}$, $Z_{in} = Z_{out} = 50\ \Omega$.

Freq GHz	S11			S21			S12			S22		
	dB	Mag	Phase	dB	Mag	Phase	dB	Mag	Phase	dB	Mag	Phase
2	-17.538	0.133	-95.400	-0.164	0.981	-3.500	-0.159	0.982	-3.400	-17.446	0.134	-96.800
5	-22.189	0.078	-116.600	-0.179	0.980	-23.300	-0.178	0.980	-23.200	-22.095	0.079	-119.300
10	-25.036	0.056	-145.600	-0.199	0.977	-50.700	-0.199	0.977	-50.700	-24.777	0.058	-148.200
15	-41.546	0.008	165.551	-0.252	0.971	-77.700	-0.250	0.972	-77.600	-38.966	0.011	123.306
16	-44.980	0.006	47.366	-0.267	0.970	-83.000	-0.266	0.970	-83.000	-38.458	0.012	78.001
17	-35.934	0.016	3.849	-0.285	0.968	-88.500	-0.283	0.968	-88.500	-33.629	0.021	45.982
18	-31.053	0.028	-3.001	-0.305	0.966	-94.000	-0.303	0.966	-94.000	-29.835	0.032	24.096
19	-27.793	0.041	-8.657	-0.326	0.963	-99.500	-0.324	0.963	-99.400	-26.940	0.045	9.650
20	-25.439	0.053	-14.670	-0.349	0.961	-105.100	-0.346	0.961	-105.000	-24.710	0.058	0.401
21	-23.677	0.065	-20.981	-0.373	0.958	-110.500	-0.371	0.958	-110.500	-22.972	0.071	-5.472
22	-22.337	0.076	-27.540	-0.398	0.955	-116.100	-0.396	0.955	-116.100	-21.606	0.083	-9.387
23	-21.317	0.086	-34.302	-0.425	0.952	-121.700	-0.423	0.952	-121.700	-20.531	0.094	-12.389
24	-20.549	0.094	-41.226	-0.452	0.949	-127.200	-0.451	0.949	-127.200	-19.685	0.104	-15.190
25	-19.986	0.100	-48.275	-0.480	0.946	-132.900	-0.479	0.946	-132.800	-19.026	0.112	-18.206
26	-19.592	0.105	-55.421	-0.509	0.943	-138.400	-0.508	0.943	-138.400	-18.518	0.119	-21.605
27	-19.342	0.108	-62.638	-0.538	0.940	-144.100	-0.538	0.940	-144.000	-18.137	0.124	-25.353
28	-19.214	0.109	-69.907	-0.567	0.937	-149.700	-0.568	0.937	-149.700	-17.859	0.128	-29.276
29	-19.189	0.110	-77.214	-0.597	0.934	-155.400	-0.598	0.934	-155.300	-17.667	0.131	-33.116
30	-19.253	0.109	-84.549	-0.626	0.930	-161.000	-0.627	0.930	-161.000	-17.546	0.133	-36.599
31	-19.390	0.107	-91.909	-0.655	0.927	-166.700	-0.657	0.927	-166.800	-17.483	0.134	-39.508
32	-19.588	0.105	-99.295	-0.685	0.924	-172.600	-0.686	0.924	-172.500	-17.467	0.134	-41.755
33	-19.834	0.102	-106.714	-0.714	0.921	-178.200	-0.715	0.921	-178.100	-17.489	0.134	-43.465
34	-20.117	0.099	-114.179	-0.743	0.918	176.000	-0.744	0.918	176.200	-17.542	0.133	-45.063
35	-20.424	0.095	-121.706	-0.772	0.915	170.200	-0.773	0.915	170.300	-17.618	0.132	-47.363
36	-20.746	0.092	-129.318	-0.801	0.912	164.500	-0.802	0.912	164.500	-17.713	0.130	-51.668
37	-21.073	0.088	-137.044	-0.830	0.909	158.400	-0.831	0.909	158.600	-17.821	0.129	-55.697
38	-21.397	0.085	-144.916	-0.861	0.906	152.500	-0.861	0.906	153.000	-17.939	0.127	-59.437
39	-21.711	0.082	-152.972	-0.893	0.902	146.900	-0.892	0.902	147.100	-18.062	0.125	-63.632
40	-22.012	0.079	-161.257	-0.926	0.899	141.100	-0.924	0.899	141.200	-18.185	0.123	-68.310
41	-22.300	0.077	-169.819	-0.962	0.895	135.200	-0.960	0.895	135.100	-18.300	0.122	-73.437
42	-22.579	0.074	-178.712	-1.001	0.891	129.000	-0.999	0.891	129.000	-18.398	0.120	-78.884
43	-22.854	0.072	167.300	-1.044	0.887	123.200	-1.042	0.887	123.300	-18.464	0.119	-84.403
44	-23.136	0.070	157.400	-1.092	0.882	117.000	-1.091	0.882	117.100	-18.478	0.119	-89.590
45	-23.435	0.067	148.300	-1.146	0.876	110.900	-1.147	0.876	111.100	-18.413	0.120	-93.848
46	-23.768	0.065	129.500	-1.208	0.870	104.700	-1.212	0.870	104.800	-18.237	0.122	-96.350

VMMK-3413 Biasing Information

Biasing and Operation

The VMMK-3413 is a 3 terminal device consisting of a “through” 50 ohm line connecting directly between the RF Input and RF Output ports and a directional coupler with a full wave detector that provides a DC output proportional to RF power input. As with any high frequency device, good grounding is required on the common port under the device for it to produce low loss in the “through” mode. A suggested PCB layout with appropriate grounding will be cover later in the application section.

With only 3 terminals available, the DC bias and detected voltage are internally DC coupled to the input and output terminals respectively. The key to successful operation of the VMMK-3413 is the use of low loss bias decoupling networks connected to both the RF Input and the RF Output ports. Figure 7 shows a simple biasing circuit.

The bias decoupling networks provide a low loss AC coupled RF path to the device, a means of biasing the device on the input, and a means of extracting the detected voltage on the output of the device. The detector needs 2 DC blocking caps, C1 and C2, on the input and output ports. This can be accomplished by printing coupled lines on the PCB or using SMT capacitors (ATC 600 series) with

values chosen for the frequency of operation. All SMT components are recommended to be no larger than 0402 size. Nominal bias voltage of 1.5 V or 0.16 mA is required for proper operation. Biasing on the input is by a way of a large value resistor R1. Its value can be computed using the following equation:

$$R1 = (Vb - 1.5) / 0.00016$$

where Vb is the supply voltage.

Detected DC voltage is extracted on the output by a way of a large value resistor R2, in the range of 10 kΩ. Bypassing capacitors C3 and C4 are needed to prevent RF influence on the DC lines. Suggested value for bypass capacitors is 1 pF.

At zero RF input power, and at 1.5 V supply bias, a nominal 63 mV offset voltage appears at the detected output port. The internal output source resistance for the detector is approximately 20 kΩ. Resistor R3 can be used as an external load resistor for the detector. Its value can be optimized for the desired Vout vs. RF input curve.

Figure 8 shows a characterization PCB used to obtain the Vdet vs. Input Power characterization data from 25 to 45 GHz. For ease in broadband characterization, two external 45 MHz – 50 GHz Bias Networks (HP 11612B) were used.

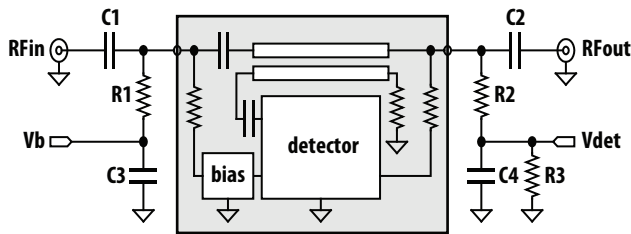

Component	Description
C1, C2	0.1 pF (ATC 600 series or printed coupled lines)
R1	$(Vb - 1.5) / 0.00016 \Omega$
R2	10 kΩ
C3, C4	1 pF
R3	External load resistor (optional)

Figure 7. Biasing the VMMK-3413 Detector Module

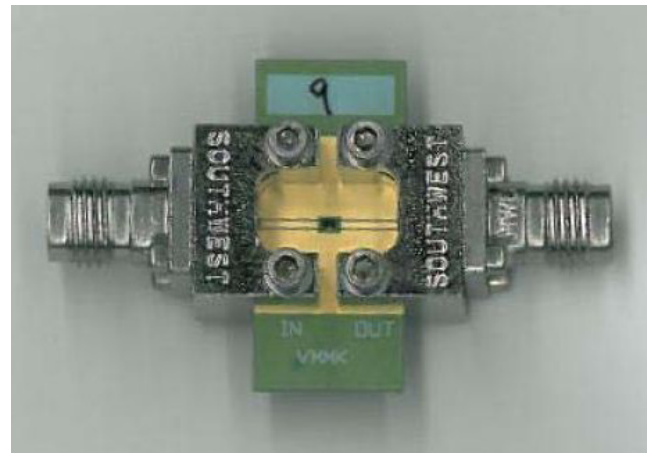

Figure 8. VMMK-3413 Characterization Board

S Parameter Measurements

The S-parameters are measured on a 0.016 inch thick RO4003 printed circuit test board, using 300 μm G-S-G (ground signal ground) probes. Coplanar waveguide is used to provide a smooth transition from the probes to the device under test. The presence of the ground plane on top of the test board results in excellent grounding at the device under test. A combination of SOLT (Short – Open – Load – Thru) and TRL (Thru – Reflect – Line) calibration techniques are used to correct for the effects of the test board, resulting in accurate device S parameters

Package and Assembly Notes

For detailed description of the device package and assembly notes, please refer to Application Note 5378.

ESD Precautions

Note: These devices are ESD sensitive. The following precautions are strongly recommended. Ensure that an ESD approved carrier is used when die are transported from one destination to another. Personal grounding is to be worn at all times when handling these devices. For more detail, refer to Avago Application Note A004R: Electrostatic Discharge Damage and Control

Ordering Information

Part Number	Devices Per Container	Container
VMMK-3413-BLKG	100	Antistatic Bag
VMMK-3413-TR1G	5000	7" Reel

Package Dimension Outline

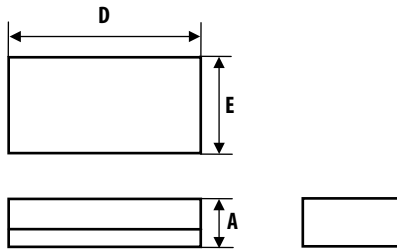

Dimensions Symbol	Min (mm)	Max (mm)
E	0.500	0.585
D	1.004	1.085
A	0.225	0.275

Note:
All dimensions are in mm

Reel Orientation

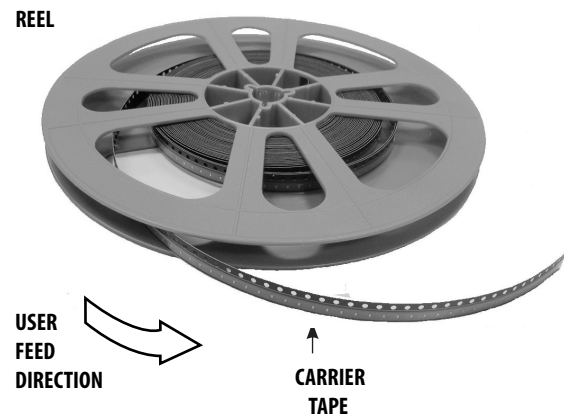

Device Orientation

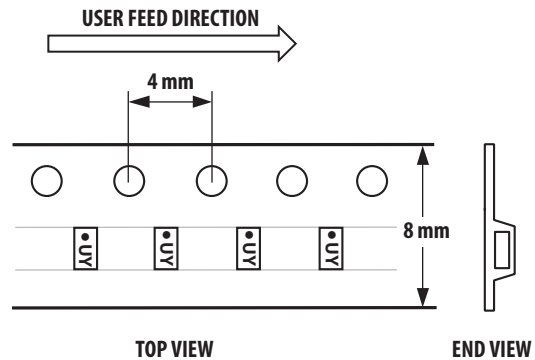

Notes:
"U" = Device Code
"Y" = Month Code

Tape Dimensions

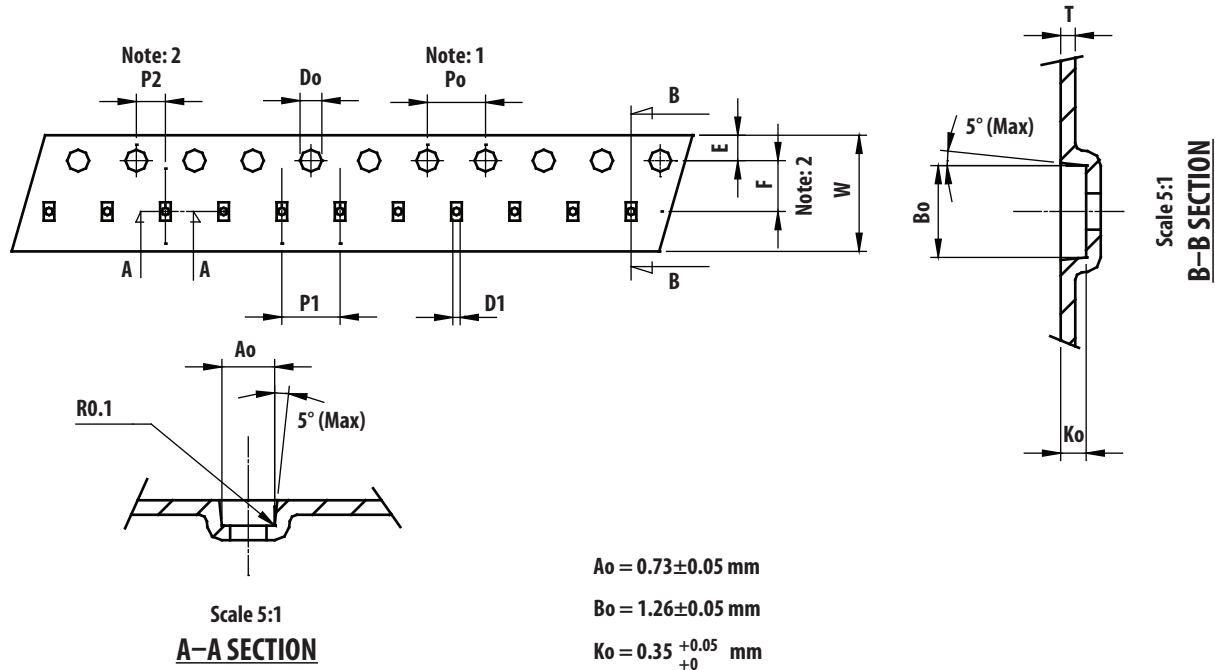

Unit: mm

Symbol	Spec.
K1	-
Po	4.0±0.10
P1	4.0±0.10
P2	2.0±0.05
Do	1.55±0.05
D1	0.5±0.05
E	1.75±0.10
F	3.50±0.05
10Po	40.0±0.10
W	8.0±0.20
T	0.20±0.02

Notice:

1. 10 Sprocket hole pitch cumulative tolerance is $\pm 0.1 \text{ mm}$.
2. Pocket position relative to sprocket hole measured as true position of pocket not pocket hole.
3. A_o & B_o measured on a plane 0.3 mm above the bottom of the pocket to top surface of the carrier.
4. K_o measured from a plane on the inside bottom of the pocket to the top surface of the carrier.
5. Carrier camber shall be not than 1 m per 100 mm through a length of 250 mm.

For product information and a complete list of distributors, please go to our web site: www.avagotech.com

Avago, Avago Technologies, and the A logo are trademarks of Avago Technologies in the United States and other countries. Data subject to change. Copyright © 2005-2012 Avago Technologies. All rights reserved. AV02-2917EN - December 26, 2012

AVAGO
TECHNOLOGIES