



SANYO Semiconductors

DATA SHEET

LV5254LG — Bi-CMOS LSI Inverting Charge Pump Regulator IC

Overview

The LV5254LG is an inverting charge pump regulator IC.

Functions

- Inverting charge pump regulator

Specifications

Absolute Maximum Ratings at $T_a = 25^\circ\text{C}$, SGND and PGND = 0V

Parameter	Symbol	Conditions	Ratings	Unit
Input supply voltage	$V_{DD\ max}$	$SV_{DD} = PV_{DD}$	6.5	V
VS pin input voltage	VS max		6.5	V
STBY pin input voltage	STBY max		6.5	V
S1 and S2 pin input voltage	S1, S2 max		6.5	V
Maximum output current	I_{OUT}		110	mA
Operating temperature	Topr		-20 to +85	$^\circ\text{C}$
Storage temperature	Tstg		-40 to +125	$^\circ\text{C}$

Recommended Operating Conditions at $T_a = 25^\circ\text{C}$, SGND and PGND = 0V

Parameter	Symbol	Conditions	Ratings	Unit
Input supply voltage	V_{DD}	$SV_{DD} = PV_{DD}$	3.5 to 6	V
VS pin input voltage	VS		1 to 4.5	V
Output current	I_{OUT}		100	mA

■ Any and all SANYO Semiconductor Co.,Ltd. products described or contained herein are, with regard to "standard application", intended for the use as general electronics equipment (home appliances, AV equipment, communication device, office equipment, industrial equipment etc.). The products mentioned herein shall not be intended for use for any "special application" (medical equipment whose purpose is to sustain life, aerospace instrument, nuclear control device, burning appliances, transportation machine, traffic signal system, safety equipment etc.) that shall require extremely high level of reliability and can directly threaten human lives in case of failure or malfunction of the product or may cause harm to human bodies, nor shall they grant any guarantee thereof. If you should intend to use our products for applications outside the standard applications of our customer who is considering such use and/or outside the scope of our intended standard applications, please consult with us prior to the intended use. If there is no consultation or inquiry before the intended use, our customer shall be solely responsible for the use.

■ Specifications of any and all SANYO Semiconductor Co.,Ltd. products described or contained herein stipulate the performance, characteristics, and functions of the described products in the independent state, and are not guarantees of the performance, characteristics, and functions of the described products as mounted in the customer's products or equipment. To verify symptoms and states that cannot be evaluated in an independent device, the customer should always evaluate and test devices mounted in the customer's products or equipment.

SANYO Semiconductor Co., Ltd.

TOKYO OFFICE Tokyo Bldg., 1-10, 1 Chome, Ueno, Taito-ku, TOKYO, 110-8534 JAPAN

LV5254LG

Electrical Characteristics

(a) Electrical Characteristics

Ta = 25°C, SV_{DD} and PV_{DD} = 4.6V, SGND and PGND = 0V, CLK = 2MHz, unless otherwise specified.

Parameter	Symbol	Conditions	Ratings			Unit
			min	typ	max	
Output ripple	V _{rp}	C2, C5 = 1μF, I _O = 60mA		20		mVp-p
Standby mode V _{DD} current	I _{ddstby}				1	μA
Operating V _{DD} current 1	I _{ddope1}	I _O = 0mA		2.2		mA
Operating V _{DD} current 2	I _{ddope2}	I _O = 60mA		3.2		mA
Power efficiency	P _{eff}	V _{DD} = 4.6V, V _{OUT} = -2.8V, I _{OUT} = 60mA		57.5		%
Reference voltage	V _{REF}		1.262	1.300	1.339	V
Overcurrent protection threshold current	I _{OCP}		115			mA
Overcurrent protection latch off wait time	t _{OCP}	F _{clk} = 2MHz		6		ms
Regulator output on time	t _{regon}	F _{clk} = 2MHz		3.5		ms
Internal clock frequency*	f _{clk}			2		MHz
Thermal shutdown circuit operating temperature	TSD	Design guarantee		170		°C
V _{OUT} discharge resistance	R _{DIS}			650		Ω
VS pin input resistance	R _{VS}		180	280	480	kΩ
STBY pin pull-down resistance	R _{SHD}		100	170	300	kΩ
STBY pin control voltage	V _{thH}		1.6		V _{DD}	V
	V _{thL}		0		0.3	V
S1 and S2 pin control voltage	V _{thH}		0.7V _{DD}		V _{DD}	V
	V _{thL}		0		0.3	V

* : The charge pump operating frequency, F_{cp}, is the internal clock frequency divided by two, i.e. F_{clk}/2.

(b) Output Characteristics

Ta = 25°C, SV_{DD} and PV_{DD} = 4.6V, SGND and PGND = 0V, CLK = 2MHz, unless otherwise specified.

Fixed Output Voltage (V_{out} = -2.8V) Mode

Outputs a fixed voltage of -2.8V determined by an internal resistor.

Parameter	Symbol	Conditions	Ratings			Unit
			min	typ	max	
Input supply voltage	V _{DD}	SV _{DD} = PV _{DD}	4.37		4.83	V
Output voltage precision	V _{OUT}	V _{DD} = +4.37 to +4.83V I _{OUT} = 60mA	-2.884	-2.8	-2.716	V
Maximum output current	I _{OUT}	V _{DD} = +4.37 to +4.83V V _{OUT} = -2.8V			70	mA

VS Mode

Outputs a voltage that is -1 times the voltage VS input to the VS pin.

Parameter	Symbol	Conditions	Ratings			Unit
			min	typ	max	
VS pin input voltage	VS		1		4.5	V
VS pin output voltage range	V _{OUT}	*1	-4.5		-1	V
Output voltage precision		VS = 1 to 2V, I _{OUT} = 0 to 60mA	-1.05VS	-VS	-0.95VS	V
Output voltage precision		VS = 2 to 4.5V, I _{OUT} = 0 to 60mA	-1.03VS	-VS	-0.97VS	V

LV5254LG

External Setting Mode

Outputs a voltage determined by external resistors and the external reference voltage.

See page 8, External Setting Mode Applications and the Output Voltage Setting Method for the method for setting the V_{OUT} voltage.

Parameter	Symbol	Conditions	Ratings			Unit
			min	typ	max	
Output voltage range	V_{OUT}	*1	-4.5		-1	V
FB pin voltage	VFB	$V_{DD} = 5V, I_{OUT} = 0 \text{ to } 100\text{mA}$	-5		20	mV
FB pin current	IFB	$V_{DD} = 5V, I_{OUT} = 0 \text{ to } 100\text{mA}$		70	200	nA

*1 : The V_{OUT} range that can be set and the current drive capacity of the charge pump regulator are, in principle, determined by the relationship between the values of the V_{DD} voltage and the set voltage. (See the "Relationship Between the Input and Output Voltages") Contact your SANYO Semiconductors representative for more detailed information.

Logic Function Tables

The pins S1 and S2 must be connected to V_{DD} (high) or ground (low) according to the mode to be used.

Mode	Description	S1	S2
Mode 1	Outputs a fixed voltage of -2.8V determined by an internal resistor.	High	Low
Mode 2	Outputs a voltage that is -1 times the voltage VS input to the VS pin.	Low	High
Mode 3	Outputs a voltage determined by an external resistor and the external reference voltage.	High	High

Package Dimensions

unit : mm (typ)

3330

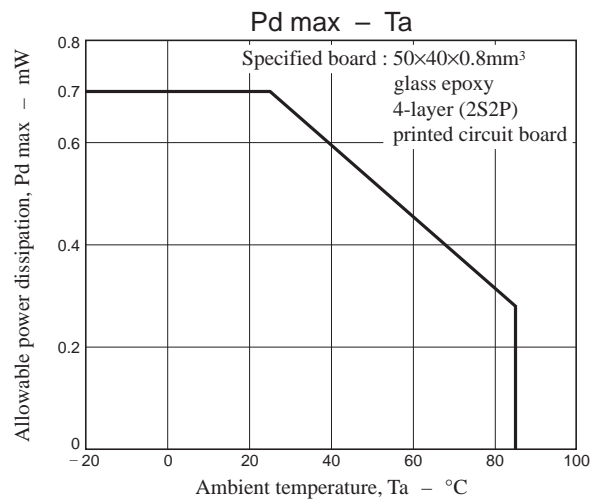
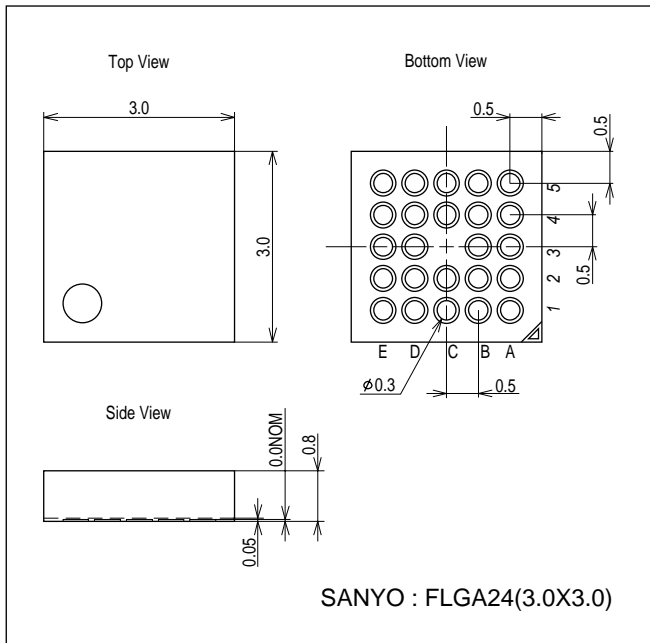

LV5254LG

Pin Assignment

FLGA24 (3mm×3mm)

	E	D	C	B	A	
			S2	SGND	VREF	1
6	5	3	1	24		
	S1	STBY	FB	VS		2
7	4	2	22	23		
SVDD	TEST			VOUT		3
9	8		20	21		
PVDD						4
11	10	14	16	19		
	C1+	PGND	C1-	C2		5
12	13	15	17	18		

TOP VIEW

Pin Descriptions

Pin No.	Pin	Functions
9	SVDD	Small signal system V _{DD}
11	PVDD	Power system V _{DD}
1	SGND	Small signal system ground
15	PGND	Power system ground
13	C1+	Inversion capacitor connection (driver side)
17	C1-	Inversion capacitor connection (charge transfer side)
18	C2	Charge pump output
21	V _{OUT}	Regulator output
24	VREF	Band gap voltage output
22	FB	Feedback pin
23	VS	VS mode output setting
2	STBY	Standby mode control
4	S1	Sensing mode selection 1
3	S2	Sensing mode selection 2
8	TEST	Test mode enable (normally not used)

* : The test mode enable pin must be left open. (There is a built-in pull-down resistor, and this pin should always be low.)

LV5254LG

Block Diagram and Application Circuit Example 1 (Internal fixed-voltage mode)

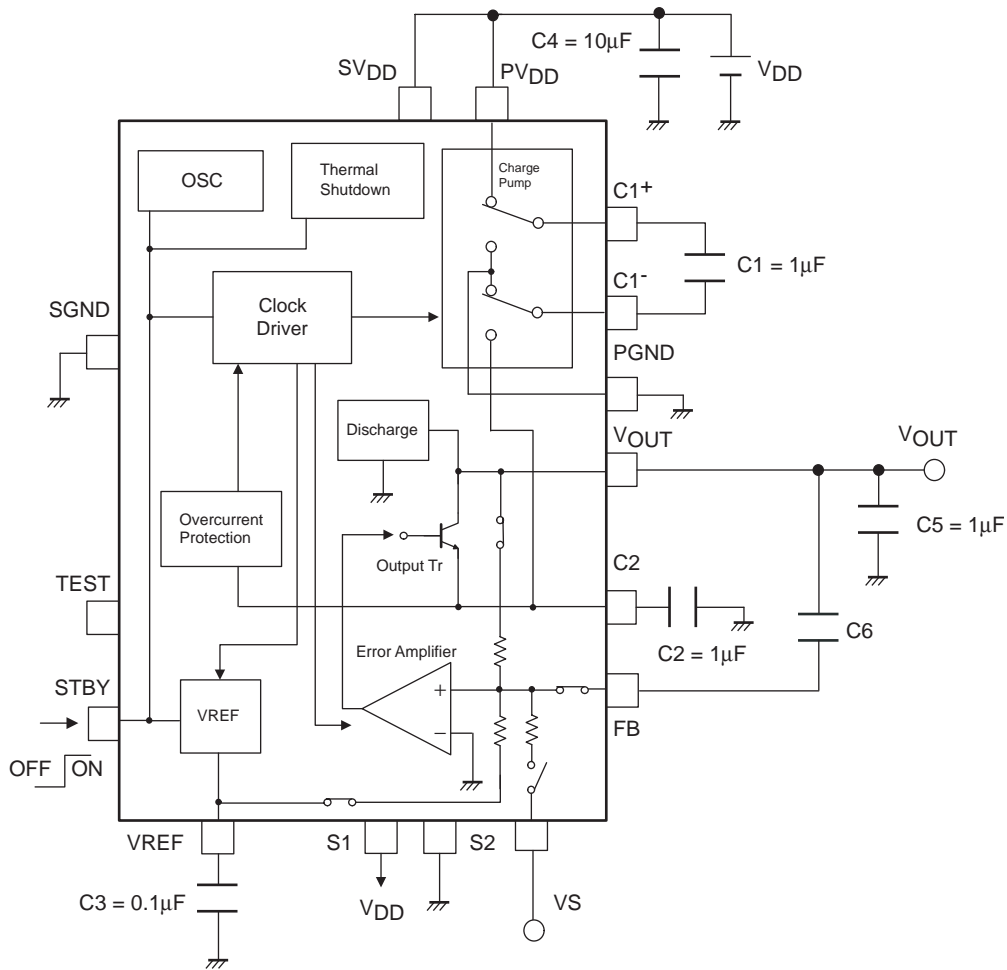

- Use ceramic capacitors for the external capacitors and connect them as close as possible to the IC. We recommend using class B devices with excellent temperature characteristics.)
- Use capacitors with the same values for the charge pump capacitors C1 and C2. We recommend a capacitance of 1µF for C1 and C2. (See figure 4 on page 10)
- SVDD and PVDD must be at the same potential. Short them together with the shortest possible line and use a ceramic capacitor with a value of 1µF or greater for C4 (which is inserted between this point and PGND). C4 must be mounted as close as possible to the IC.
- C6 is a phase compensation capacitor. It is required for stable regulator operation.

LV5254LG

Recommended Power On and Off Sequences

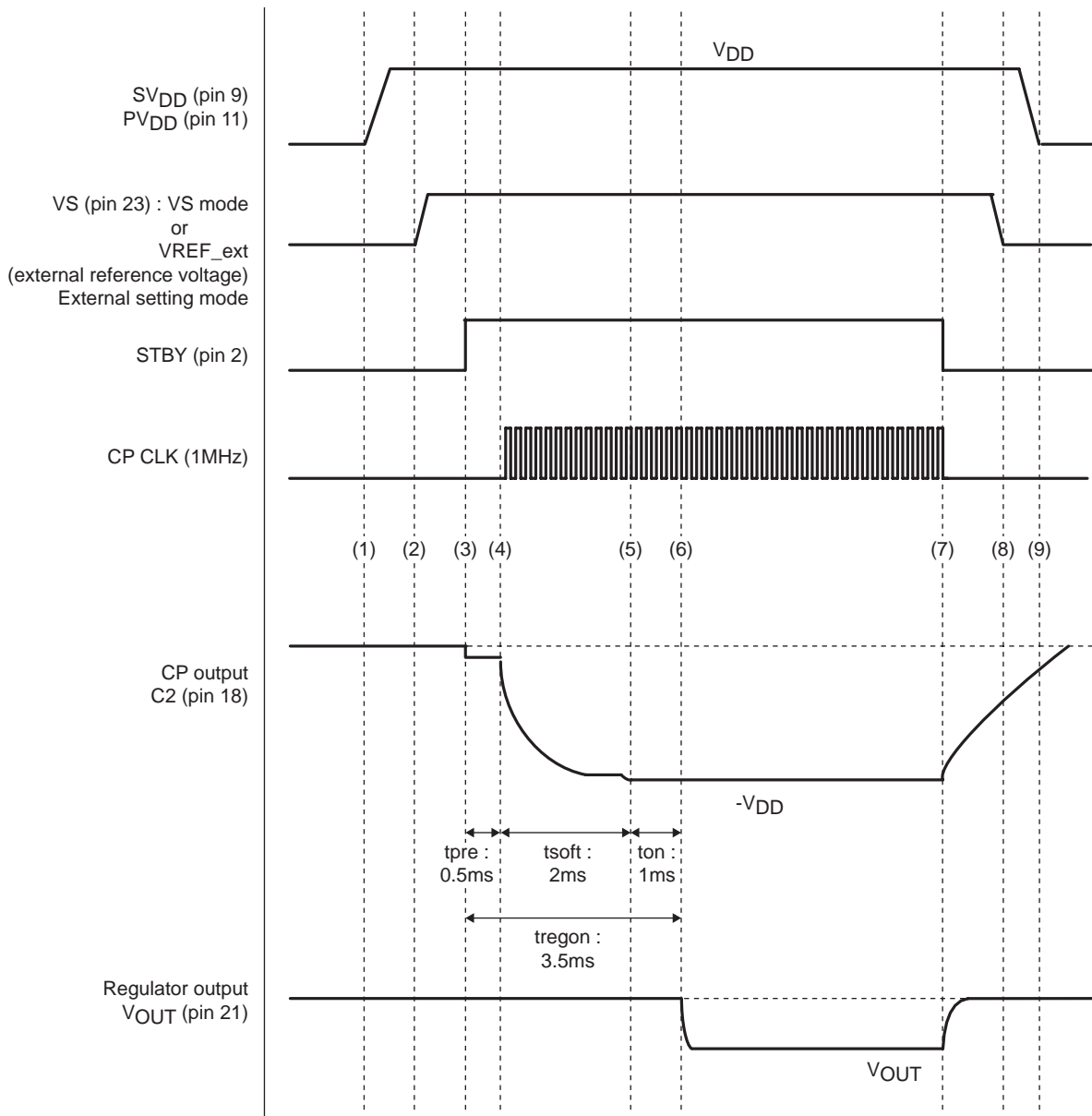

- (1) Apply the V_{DD} voltage to the SV_{DD} and PV_{DD} pins.
- (2) If VS mode is used, apply the VS voltage. If external setting mode is used, apply the external reference voltage.
- (3) Start pre-charging the flying capacitor with a high-level input to the $STBY$ pin.
- (4) Start charging the pump-up capacitor with the charge pump sub-driver (soft start).
- (5) Switch to the charge pump driver. This starts charging of the pump-up capacitor by the main driver.
- (6) Regulator output starts.
- (7) Stop IC drive by applying a low-level input to the $STBY$ pin to start V_{OUT} output discharge operation by the internal discharge transistor. (This operates when the $STBY$ pin is low.)
- (8) If VS mode is used, shut down the VS voltage, and if external setting mode is used, shut down the external reference voltage.
- (9) Shut down the V_{DD} voltage.

Overcurrent Protection Operation

This IC includes a function that protects against overcurrent in V_{OUT} . If the V_{OUT} output is shorted and a large current flows, the IC will latch and stop the output. To recover from this stopped state, set the STBY pin low and then set it high again.

External Setting Mode Applications and the Output Voltage Setting Method

In the LV5254's external setting mode, the output voltage is set by the external resistors R1 and R2 and by the external reference voltage, V_{ref_ext} . In this mode, the output voltage is expressed by equation (1). The second term in equation (1) is the error amplifier's offset component and the third term is the offset component due to the feedback current. The voltage precision achieved by an application can be determined by considering the tolerances of the parameters in equation (1).

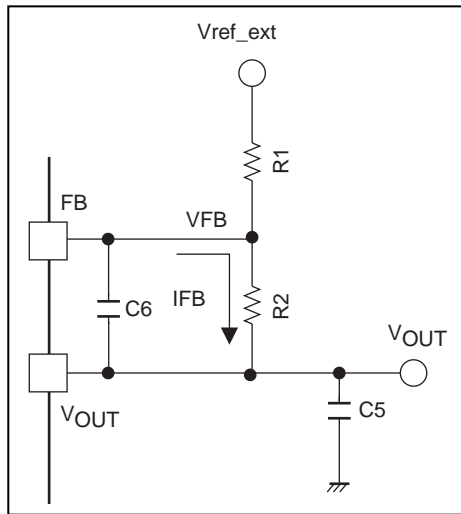

$$V_{OUT} = -\frac{R2}{R1} \cdot V_{ref_ext} + \frac{R1+R2}{R1} \cdot V_{FB} - R2 \cdot I_{FB} \dots (1)$$

Relationship Between the Input and Output Voltages

Equation (2) gives the relationship between the input voltage and output voltage. In the LV5254, a charge pump circuit generates VC2, which is the VIN level inverted, and generates the output voltage VOUT by regulating that inverted voltage. In this case, due to the charge pump block impedance Ron, the voltage drop IO × Ron (where IO is the load current) is generated. (* Here we are ignoring the capacitor loss components in the charge pump capacitors C1 and C2.) The LV5254's current capacity is expressed by equation (3). At this time, the impedance Ron increases with temperature. Thus the current capacity decreases with increasing temperature.

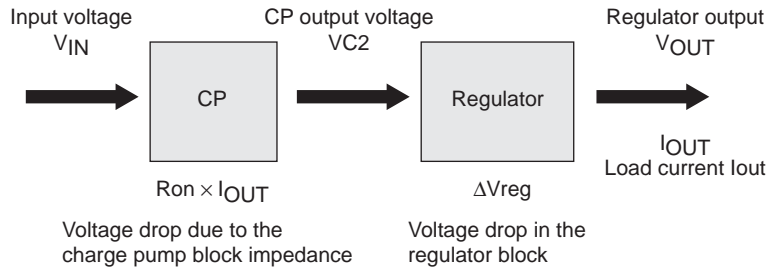

$$V_{OUT} = VC2 + \Delta V_{reg} = (-V_{IN} + R_{on} \times I_{OUT}) + \Delta V_{reg} \dots (2)$$

VOUT : Output voltage, VIN : Input voltage, IOOUT : Load current, Ron : Charge pump block impedance, ΔVreg : Regulator voltage drop

$$I_{O \text{ [max]}} = (V_{IN} + V_{OUT} - \Delta V_{reg \text{ [min]}}) / R_{on} \dots (3)$$

IO [max] : Maximum load current, ΔVreg [min] : Minimum regulator voltage drop

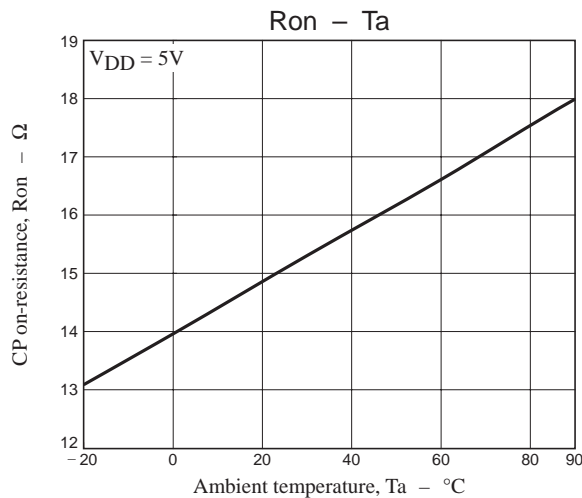

Figure 1 : Charge Pump Block Impedance Temperature Characteristics : Assumed Worst Case (C1, C2 = 1μF)

LV5254LG

Next, consider figure 2, which shows the relationship between the input voltage V_{IN} and the charge pump block impedance R_{on} at $T_a = 85^\circ\text{C}$, which is the maximum temperature for which operation is guaranteed. At $T_a = 85^\circ\text{C}$, if $\Delta V_{reg} [\text{min}] = 0.3\text{V}$ (inferred worst case value), the LV5254's maximum output current can be expressed as equation (4).

$$I_O [\text{max}] = (V_{IN} + V_{OUT} - 0.3) / R_{on} \dots (4)$$

The current capacity shown in figure 3 can be determined from the characteristics in figure 2 when V_{OUT} is set to be -3V .

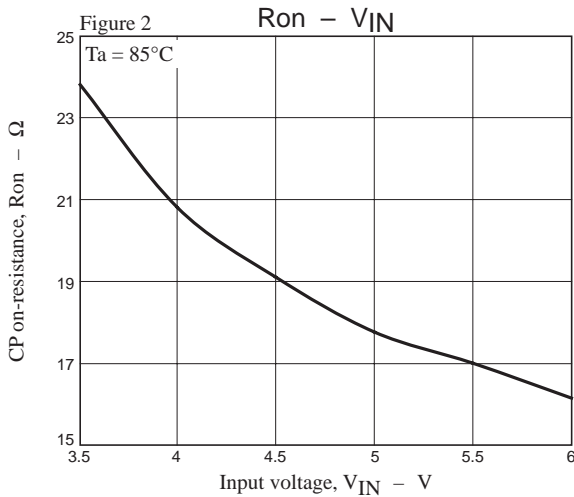

Figure 2 : Charge Pump Block Impedance - Input Voltage Characteristics ($T_a = 85^\circ\text{C}$) : Assumed Worst Case ($C_1, C_2 = 1\mu\text{F}$)

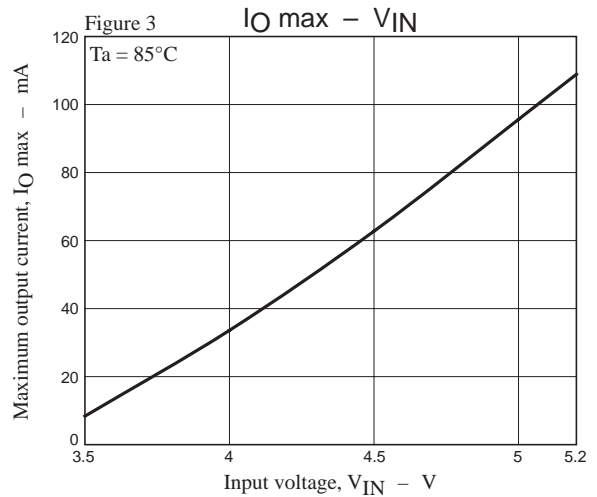

Figure 3 : Maximum Output Current - Input Voltage Characteristics when $V_{OUT} = -3\text{V}$ ($T_a = 85^\circ\text{C}$) : Assumed Worst Case ($C_1, C_2 = 1\mu\text{F}$)

Caution : The characteristics values presented in this reference documentation are nothing other than inferred worst-case values. No guarantee or warranty is made with respect to these values.

Loss in the Charge Pump Capacitors

Voltage loss occurs in the pump capacitors C_1 and C_2 in the charge pump circuit. Figure 4 shows the charge pump output vs. load current characteristics (with the C_1 and C_2 value as a parameter) at room temperature when $V_{DD} = 5\text{V}$. Note that the load regulation becomes worse as the value of the capacitors C_1 and C_2 is reduced. To minimize the loss in these capacitor, we recommend using a value of $1\mu\text{F}$ for C_1 and C_2 .

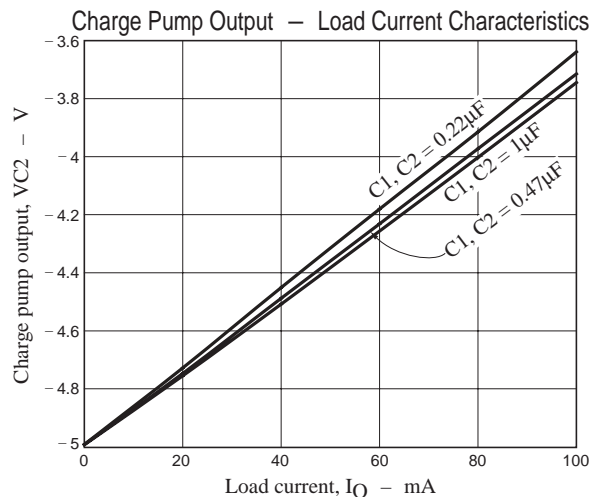
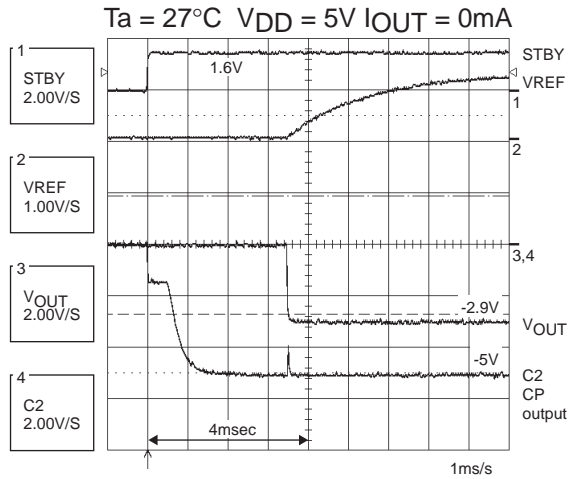

Figure 4 : Charge Pump Output - Load Current Characteristics when $V_{DD} = 5\text{V}$, data provided for reference purposes.

IC start and stop

1. Startup waveform (External setting mode)



(a) No load - Startup waveform

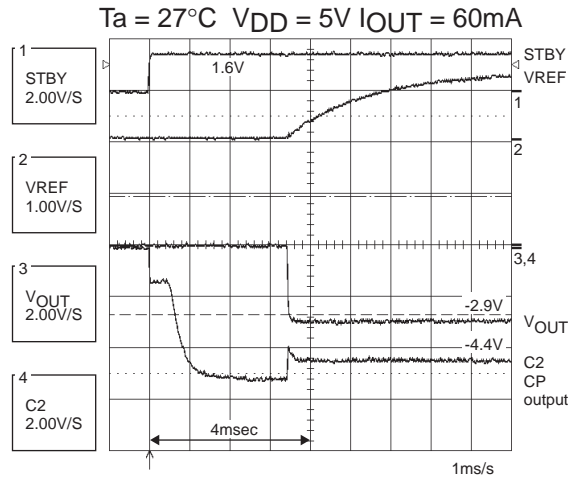

(b) 50Ω - Startup waveform

2. Falling waveform (External setting mode)

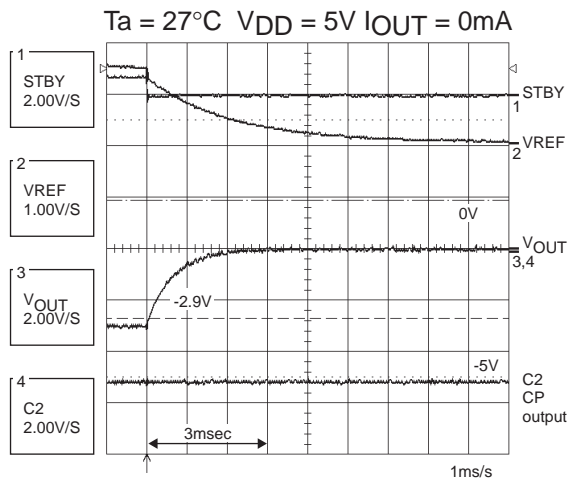

(a) No load - Falling waveform

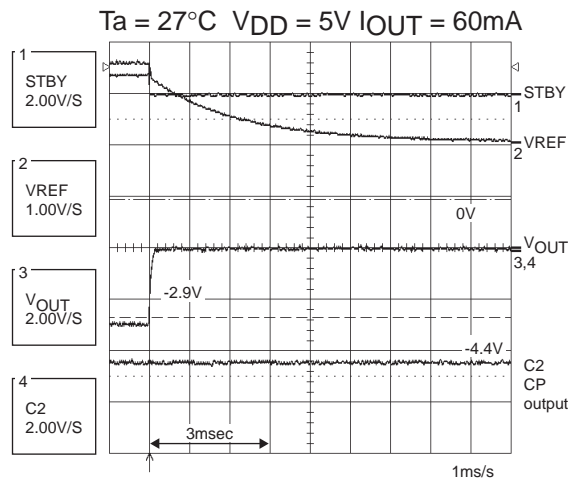

(b) 50Ω - Falling waveform

Internal fixed mode - Regulator

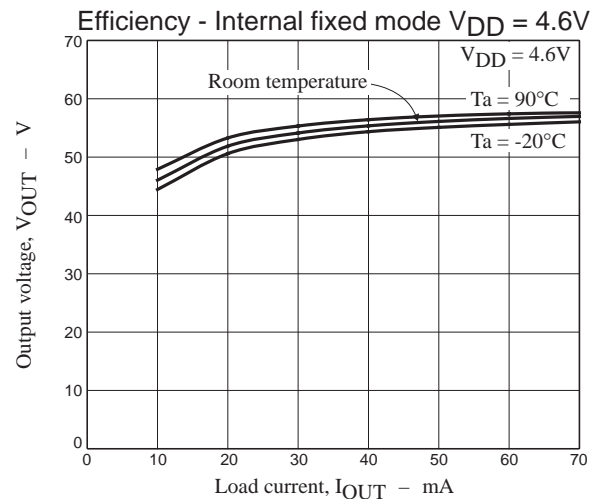
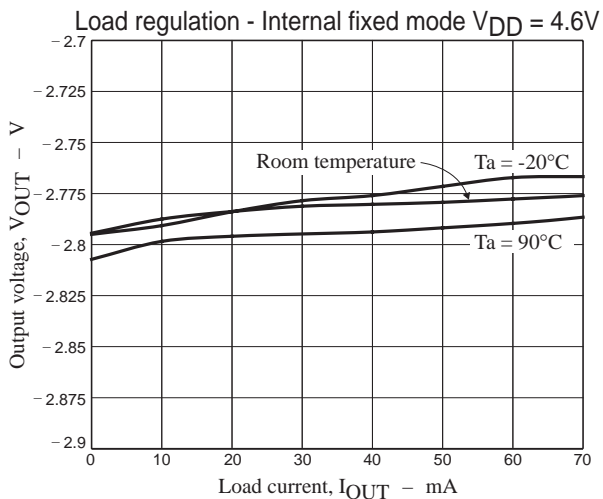

LV5254LG

VS mode - Regulator

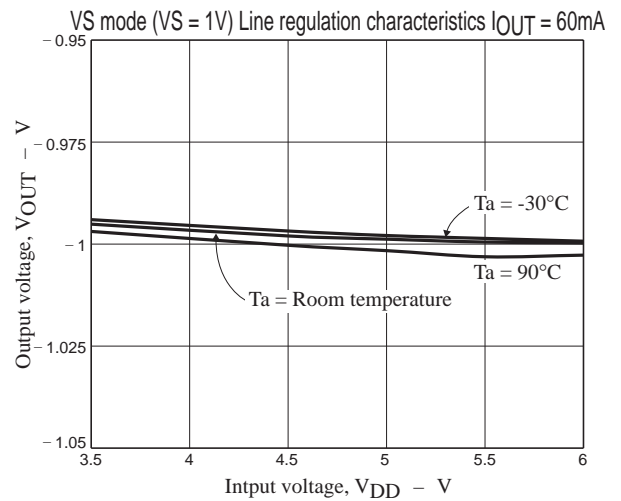
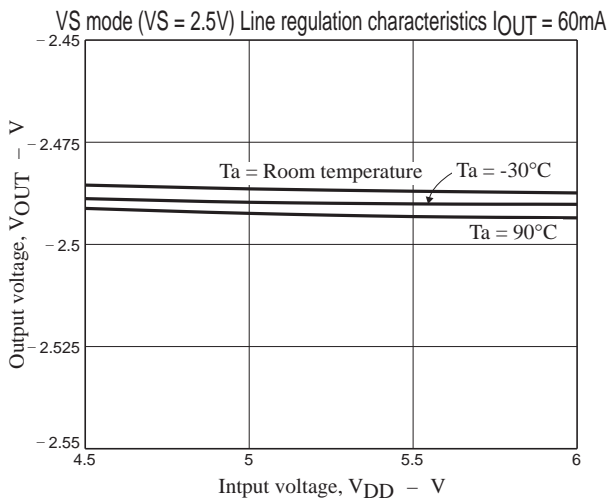
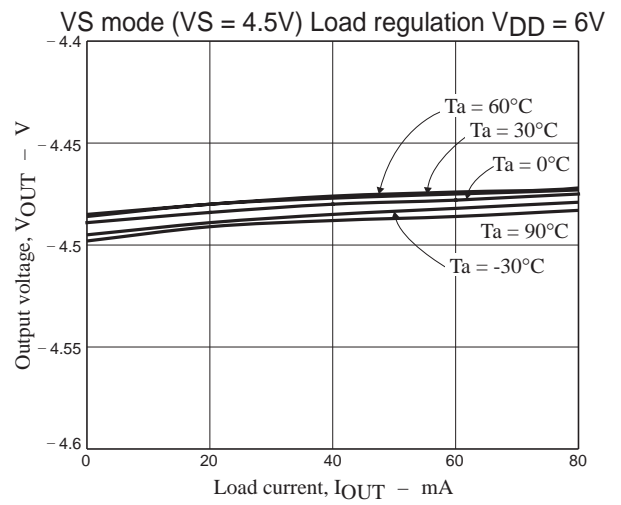
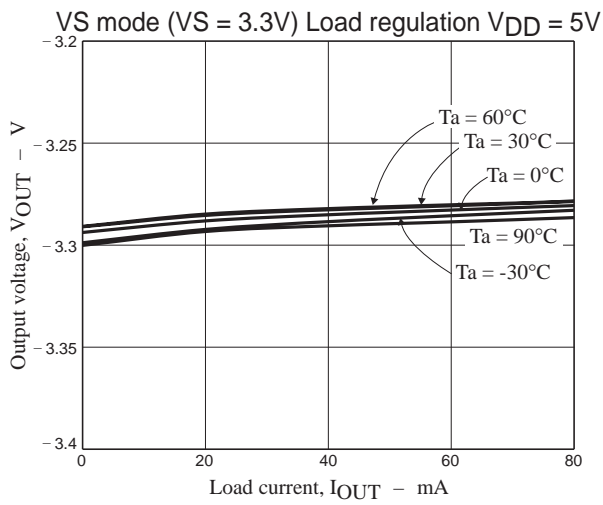
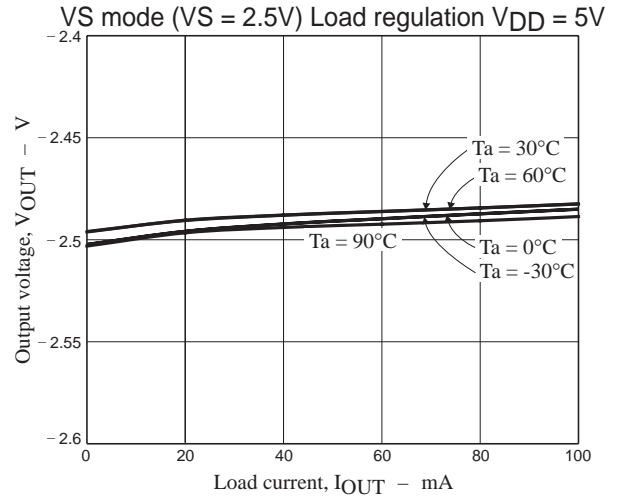
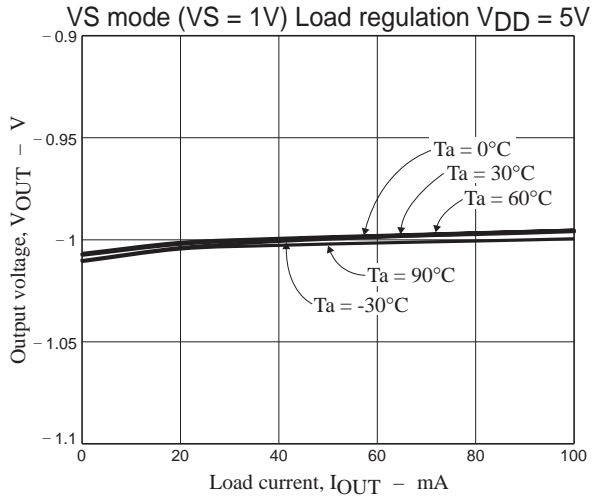

LV5254LG

External Setting Mode Applications and the Output Voltage Setting Method

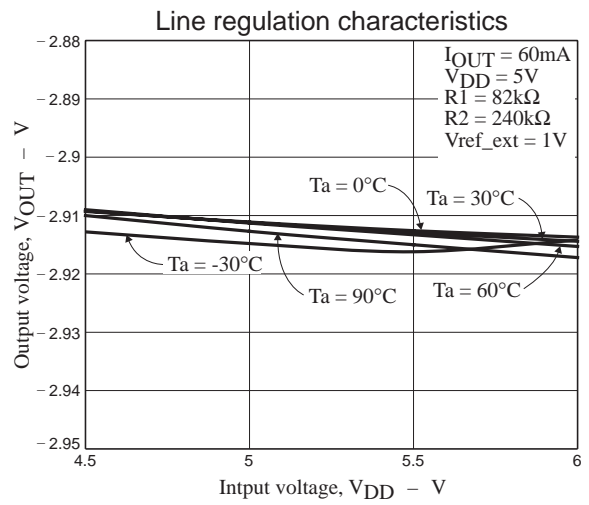
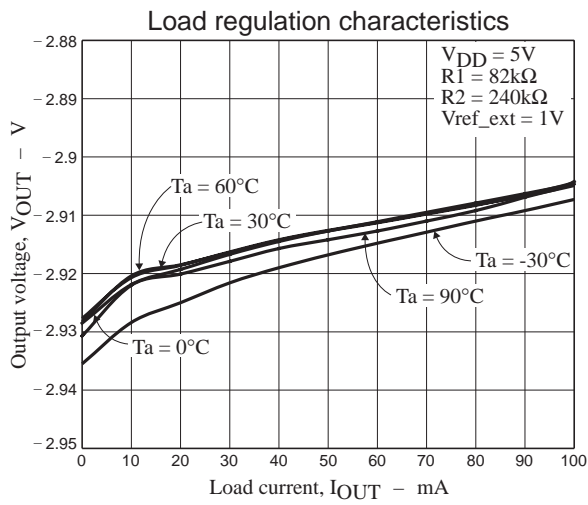

Overcurrent protection function detection current value

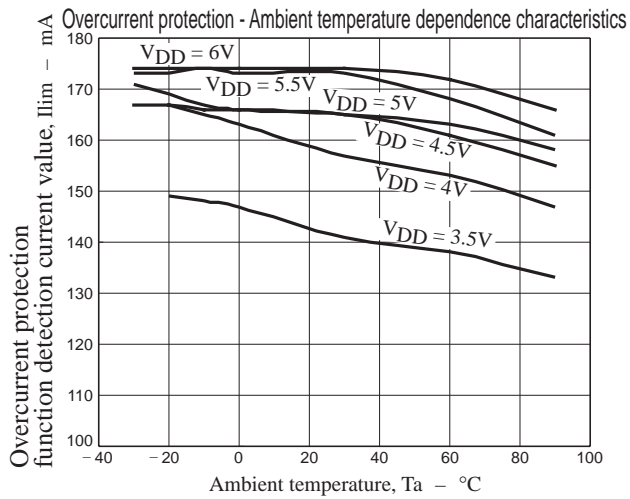

- SANYO Semiconductor Co.,Ltd. assumes no responsibility for equipment failures that result from using products at values that exceed, even momentarily, rated values (such as maximum ratings, operating condition ranges, or other parameters) listed in products specifications of any and all SANYO Semiconductor Co.,Ltd. products described or contained herein.
- SANYO Semiconductor Co.,Ltd. strives to supply high-quality high-reliability products, however, any and all semiconductor products fail or malfunction with some probability. It is possible that these probabilistic failures or malfunction could give rise to accidents or events that could endanger human lives, trouble that could give rise to smoke or fire, or accidents that could cause damage to other property. When designing equipment, adopt safety measures so that these kinds of accidents or events cannot occur. Such measures include but are not limited to protective circuits and error prevention circuits for safe design, redundant design, and structural design.
- In the event that any or all SANYO Semiconductor Co.,Ltd. products described or contained herein are controlled under any of applicable local export control laws and regulations, such products may require the export license from the authorities concerned in accordance with the above law.
- No part of this publication may be reproduced or transmitted in any form or by any means, electronic or mechanical, including photocopying and recording, or any information storage or retrieval system, or otherwise, without the prior written consent of SANYO Semiconductor Co.,Ltd.
- Any and all information described or contained herein are subject to change without notice due to product/technology improvement, etc. When designing equipment, refer to the "Delivery Specification" for the SANYO Semiconductor Co.,Ltd. product that you intend to use.
- Information (including circuit diagrams and circuit parameters) herein is for example only; it is not guaranteed for volume production.
- Upon using the technical information or products described herein, neither warranty nor license shall be granted with regard to intellectual property rights or any other rights of SANYO Semiconductor Co.,Ltd. or any third party. SANYO Semiconductor Co.,Ltd. shall not be liable for any claim or suits with regard to a third party's intellectual property rights which has resulted from the use of the technical information and products mentioned above.

This catalog provides information as of March, 2007. Specifications and information herein are subject to change without notice.