



## IR Receiver Modules for Remote Control Systems



16797

### MECHANICAL DATA

#### Pinning

1 = GND, 2 = GND, 3 = V<sub>S</sub>, 4 = OUT

### DESCRIPTION

The TSOP362.. series are miniaturized SMD-IR receiver modules for infrared remote control systems. PIN diode and preamplifier are assembled on lead frame, the epoxy package is designed as IR filter.

The demodulated output signal can directly be decoded by a microprocessor. TSOP362.. is the standard IR remote control SMD-receiver series, for 3 V supply voltage supporting all major transmission codes.

This component has not been qualified according to automotive specifications.

### FEATURES

- Photo detector and preamplifier in one package
- Internal filter for PCM frequency
- Continuous data transmission possible
- TTL and CMOS compatibility
- Output active low
- Low power consumption
- High immunity against ambient light
- Supply voltage: 2.7 V to 5.5 V
- Compliant to RoHS Directive 2011/65/EU and in accordance to WEEE 2002/96/EC



RoHS  
COMPLIANT

### SPECIAL FEATURES

- Improved immunity against ambient light
- Suitable burst length  $\geq 10$  cycles/burst
- Taping available for topview and sideview assembly

PARTS TABLE	
CARRIER FREQUENCY	STANDARD APPLICATIONS (AGC2/AGC8)
36 kHz	TSOP36236
38 kHz	TSOP36238
40 kHz	TSOP36240
56 kHz	TSOP36256

### BLOCK DIAGRAM



16839

### APPLICATION CIRCUIT

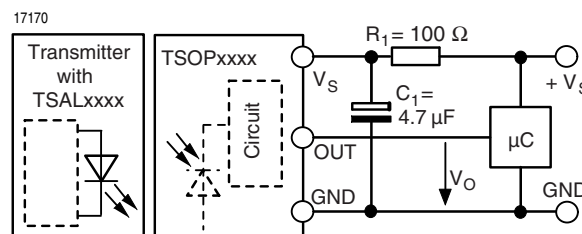

R<sub>1</sub> and C<sub>1</sub> recommended to suppress power supply disturbances. The output voltage should not be hold continuously at a voltage below V<sub>O</sub> = 2.0 V by the external circuit.



ABSOLUTE MAXIMUM RATINGS (T <sub>amb</sub> = 25 °C, unless otherwise specified)				
PARAMETER	TEST CONDITION	SYMBOL	VALUE	UNIT
Supply voltage (pin 3)		V <sub>S</sub>	- 0.3 to + 6	V
Supply current (pin 3)		I <sub>S</sub>	3	mA
Output voltage (pin 4)		V <sub>O</sub>	- 0.3 to (V <sub>S</sub> + 0.3)	V
Output current (pin 4)		I <sub>O</sub>	10	mA
Junction temperature		T <sub>J</sub>	100	°C
Storage temperature range		T <sub>stg</sub>	- 40 to + 100	°C
Operating temperature range		T <sub>amb</sub>	- 25 to + 85	°C
Power consumption	T <sub>amb</sub> ≤ 85 °C	P <sub>tot</sub>	30	mW

**Note**

- Stresses beyond those listed under “Absolute Maximum Ratings” may cause permanent damage to the device. This is a stress rating only and functional operation of the device at these or any other conditions beyond those indicated in the operational sections of this specification is not implied. Exposure to absolute maximum rating conditions for extended periods may affect the device reliability.

ELECTRICAL AND OPTICAL CHARACTERISTICS (T <sub>amb</sub> = 25 °C, unless otherwise specified)						
PARAMETER	TEST CONDITION	SYMBOL	MIN.	TYP.	MAX.	UNIT
Supply current	E <sub>v</sub> = 0	I <sub>SD</sub>	0.7	1.2	1.5	mA
	E <sub>v</sub> = 40 klx, sunlight	I <sub>SH</sub>		1.3		mA
Supply voltage		V <sub>S</sub>	2.7		5.5	V
Transmission distance	E <sub>v</sub> = 0, test signal see fig. 1, IR diode TSAL6200, I <sub>F</sub> = 250 mA	d		35		m
Output voltage low	I <sub>O</sub> SL = 0.5 mA, E <sub>e</sub> = 0.7 mW/m <sup>2</sup> , test signal see fig. 1	V <sub>O</sub> SL			250	mV
Minimum irradiance (30 kHz to 40 kHz)	V <sub>S</sub> = 3 V, pulse width tolerance: t <sub>pi</sub> - 5/f <sub>o</sub> < t <sub>po</sub> < t <sub>pi</sub> + 6/f <sub>o</sub> , test signal see fig. 1	E <sub>e</sub> min.		0.35	0.5	W/m <sup>2</sup>
Minimum irradiance (56 kHz)	V <sub>S</sub> = 3 V, pulse width tolerance: t <sub>pi</sub> - 5/f <sub>o</sub> < t <sub>po</sub> < t <sub>pi</sub> + 6/f <sub>o</sub> , test signal see fig. 1	E <sub>e</sub> min.		0.4	0.6	W/m <sup>2</sup>
Minimum irradiance (30 kHz to 40 kHz)	V <sub>S</sub> = 5 V, pulse width tolerance: t <sub>pi</sub> - 5/f <sub>o</sub> < t <sub>po</sub> < t <sub>pi</sub> + 6/f <sub>o</sub> , test signal see fig. 1	E <sub>e</sub> min.		0.45	0.6	W/m <sup>2</sup>
Minimum irradiance (56 kHz)	V <sub>S</sub> = 5 V, pulse width tolerance: t <sub>pi</sub> - 5/f <sub>o</sub> < t <sub>po</sub> < t <sub>pi</sub> + 6/f <sub>o</sub> , test signal see fig. 1	E <sub>e</sub> min.		0.5	0.7	W/m <sup>2</sup>
Maximum irradiance	t <sub>pi</sub> - 5/f <sub>o</sub> < t <sub>po</sub> < t <sub>pi</sub> + 6/f <sub>o</sub> , test signal see fig. 3	E <sub>e</sub> max.	30			W/m <sup>2</sup>
Directivity	Angle of half transmission distance	φ <sub>1/2</sub>		± 45		deg

**TYPICAL CHARACTERISTICS** (T<sub>amb</sub> = 25 °C, unless otherwise specified)



Fig. 1 - Output Function



Fig. 2 - Pulse Length and Sensitivity in Dark Ambient

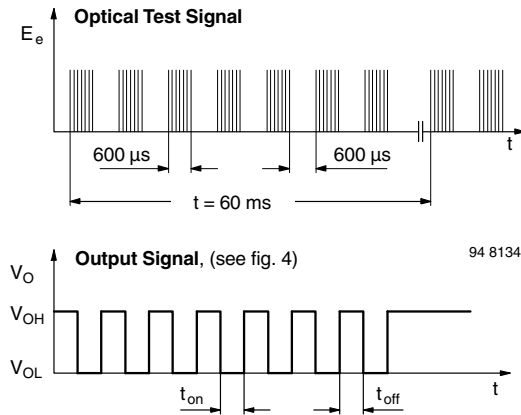

Fig. 3 - Output Function

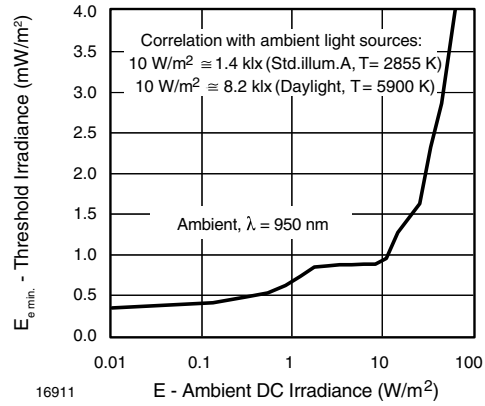

Fig. 6 - Sensitivity in Bright Ambient

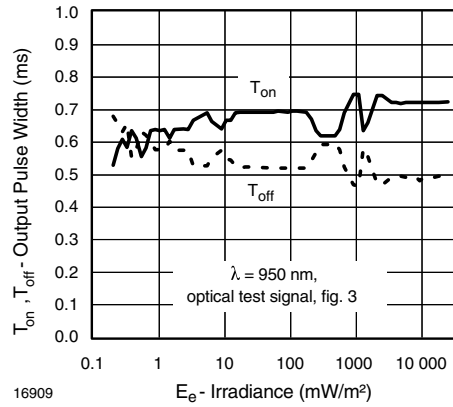

Fig. 4 - Output Pulse Diagram

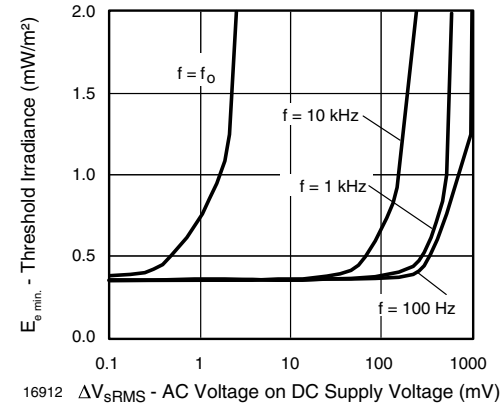

Fig. 7 - Sensitivity vs. Supply Voltage Disturbances

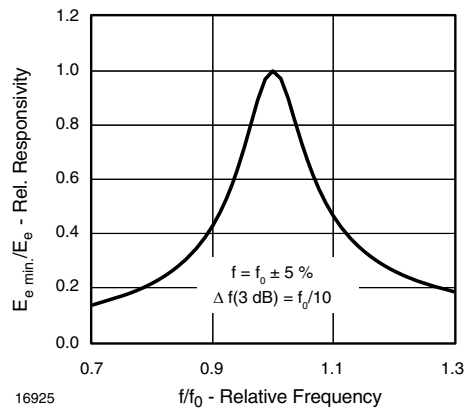

Fig. 5 - Frequency Dependence of Responsivity

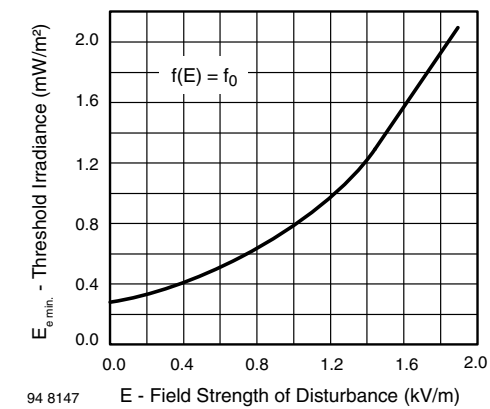

Fig. 8 - Sensitivity vs. Electric Field Disturbances

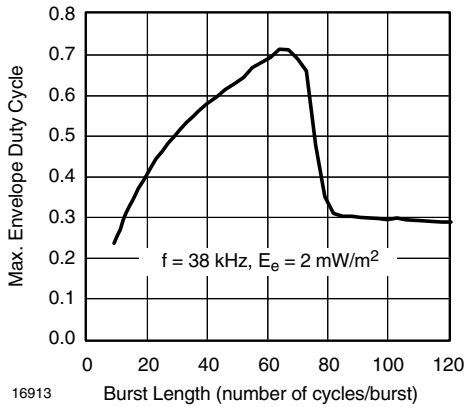

Fig. 9 - Max. Envelope Duty Cycle vs. Burstlength



Fig. 12 - Directivity



Fig. 10 - Sensitivity vs. Ambient Temperature



Fig. 13 - Sensitivity vs. Supply Voltage

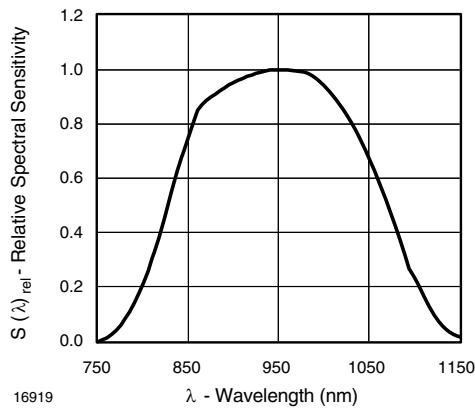

Fig. 11 - Relative Spectral Sensitivity vs. Wavelength



### SUITABLE DATA FORMAT

The circuit of the TSOP362.. is designed so that unexpected output pulses due to noise or disturbance signals are avoided. A bandpass filter, an integrator stage and an automatic gain control are used to suppress such disturbances.

The distinguishing mark between data signal and disturbance signal are carrier frequency, burst length and duty cycle.

The data signal should fulfill the following conditions:

- Carrier frequency should be close to center frequency of the bandpass (e.g. 38 kHz)
- Burst length should be 10 cycles/burst or longer
- After each burst which is between 10 cycles and 70 cycles a gap time of at least 14 cycles is necessary
- For each burst which is longer than 1.8 ms a corresponding gap time is necessary at some time in the data stream. This gap time should be at least 6 times longer than the burst
- Up to 800 short bursts per second can be received continuously

Some examples for suitable data format are: NEC code (repetitive pulse), NEC code (repetitive data), Toshiba Micom Format, Sharp code, RC5 Code, RC6 code, R-2000 code, Sony code.

When a disturbance signal is applied to the TSOP362.. it can still receive the data signal. However the sensitivity is reduced to that level that no unexpected pulses will occur.

Some examples for such disturbance signals which are suppressed by the TSOP362.. are:

- DC light (e.g. from tungsten bulb or sunlight)
- Continuous signal at 38 kHz or at any other frequency
- Signals from fluorescent lamps with electronic ballast with high or low modulation (see fig. 14 or fig.15)



Fig. 14 - IR Signal from Fluorescent Lamp with Low Modulation



Fig. 15 - IR Signal from Fluorescent Lamp with High Modulation



**PACKAGE DIMENSIONS** in millimeters



Drawing-No.: 6.544-5341.01-4  
 Issue: 8; 02.09.09  
 16776

**ASSEMBLY INSTRUCTIONS**

**Reflow Soldering**

- Reflow soldering must be done within 72 h while stored under a max. temperature of 30 °C, 60 % RH after opening the dry pack envelope
- Set the furnace temperatures for pre-heating and heating in accordance with the reflow temperature profile as shown in the diagram. Exercise extreme care to keep the maximum temperature below 260 °C. The temperature shown in the profile means the temperature at the device surface. Since there is a temperature difference between the component and the circuit board, it should be verified that the temperature of the device is accurately being measured

- Handling after reflow should be done only after the work surface has been cooled off

**Manual Soldering**

- Use a soldering iron of 25 W or less. Adjust the temperature of the soldering iron below 300 °C
- Finish soldering within 3 s
- Handle products only after the temperature has cooled off



**VISHAY LEAD (Pb)-FREE REFLOW SOLDER PROFILE**



**TAPING VERSION TSOP..TT DIMENSIONS** in millimeters

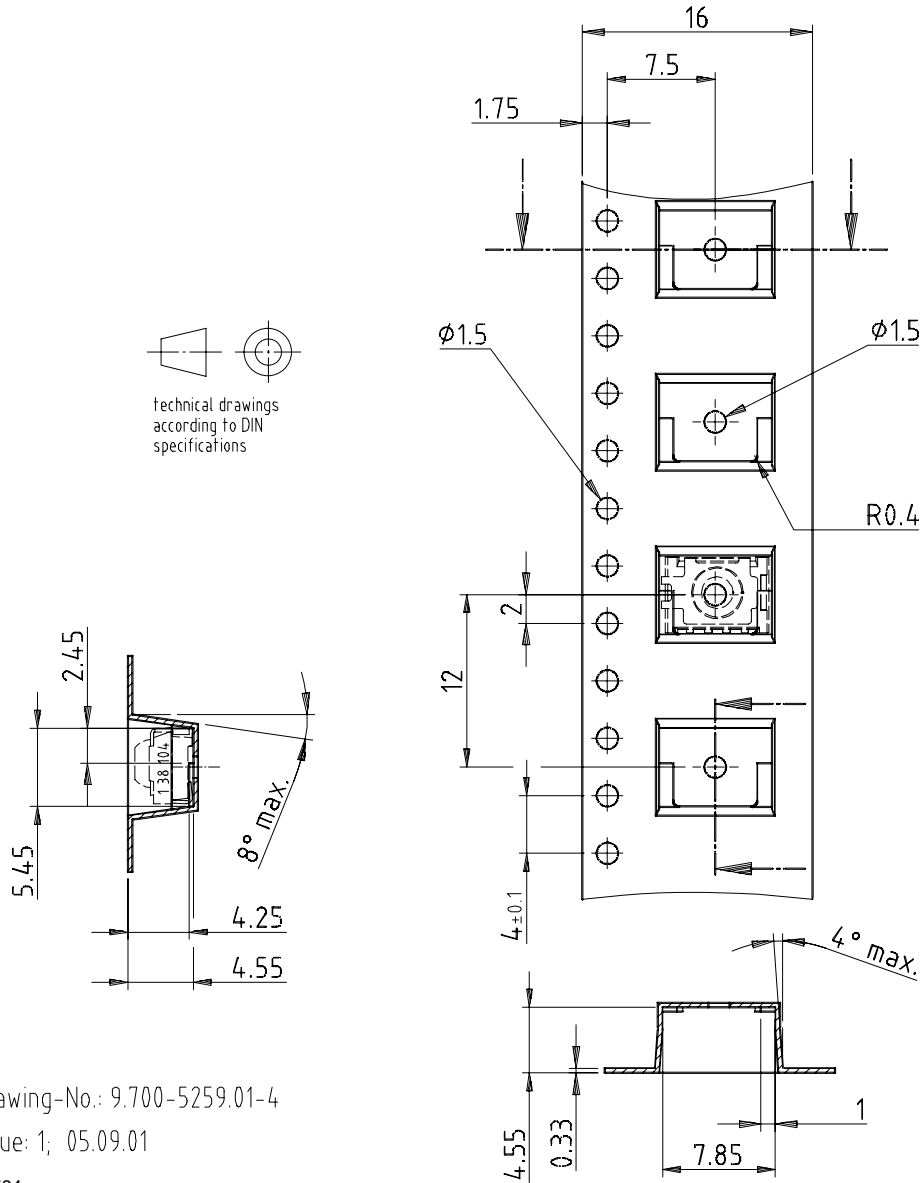

Drawing-No.: 9.700-5259.01-4

Issue: 1; 05.09.01

16584



TAPING VERSION TSOP..TR DIMENSIONS in millimeters

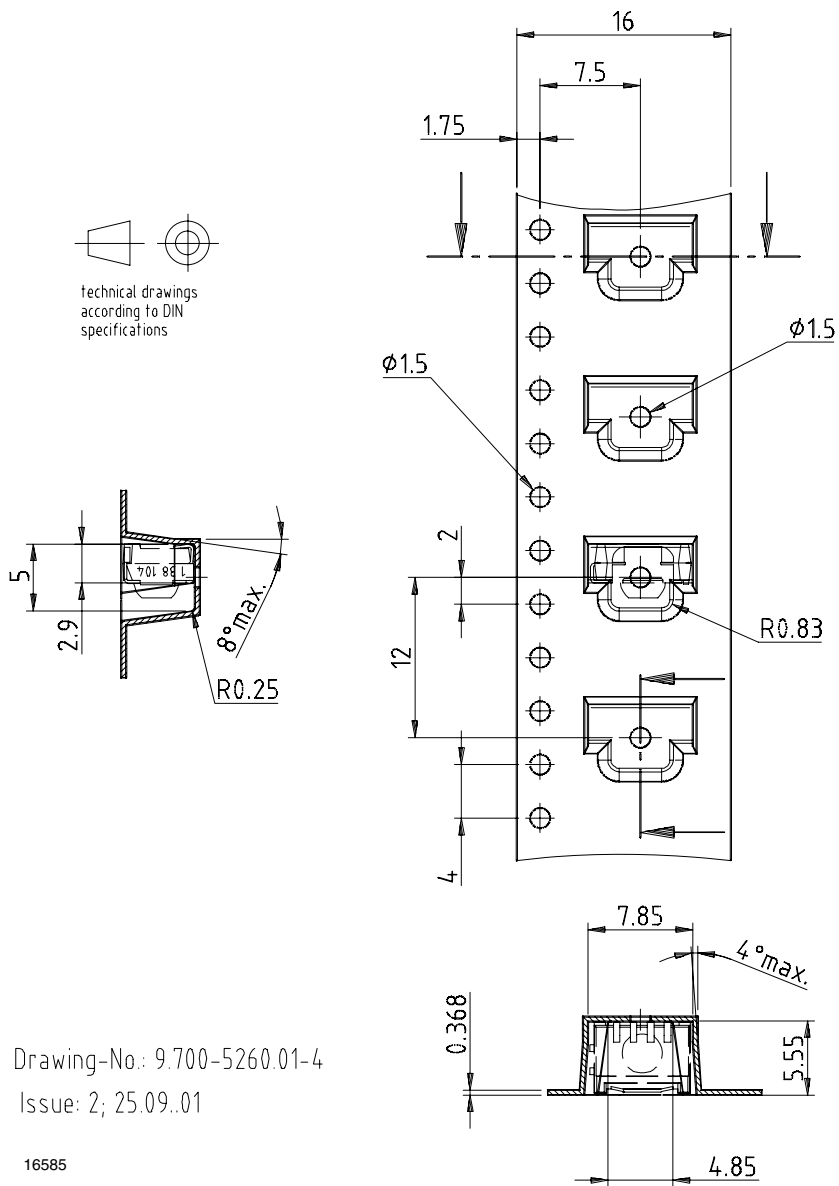



**REEL DIMENSIONS** in millimeters



Form of the leave open of the wheel is supplier specific.

Dimension acc. to IEC EN 60 286-3

Tape width 16

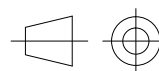

technical drawings according to DIN specifications

Drawing-No.: 9.800-5052.V2-4

Issue: 1; 07.05.02

16734

**LEADER AND TRAILER DIMENSIONS** in millimeters

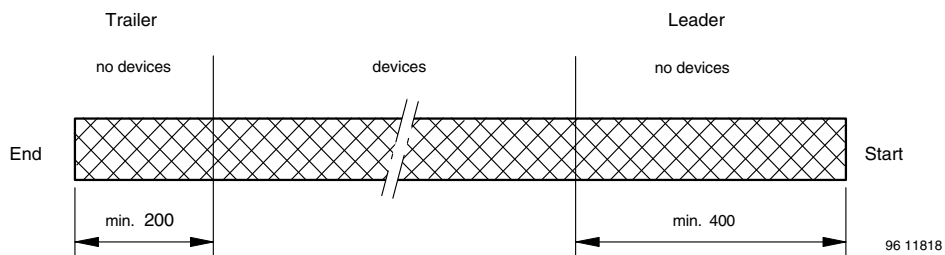

**COPER TAPE PEEL STRENGTH**

According to DIN EN 60286-3

0.1 N to 1.3 N

(300 ± 10) mm/min.

165° to 180° peel angle

**LABEL**

**Standard bar code labels for finished goods**

The standard bar code labels are product labels and used for identification of goods. The finished goods are packed in final packing area. The standard packing units are labeled with standard bar code labels before transported as finished goods to warehouses. The labels are on each packing unit and contain Vishay Semiconductor GmbH specific data.

VISHAY SEMICONDUCTOR GMBH STANDARD BAR CODE PRODUCT LABEL (finished goods)		
PLAIN WRITING	ABBREVIATION	LENGTH
Item-description	-	18
Item-number	INO	8
Selection-code	SEL	3
LOT-/serial-number	BATCH	10
Data-code	COD	3 (YWW)
Plant-code	PTC	2
Quantity	QTY	8
Accepted by	ACC	-
Packed by	PCK	-
Mixed code indicator	MIXED CODE	-
Origin	xxxxxxx+	Company logo
LONG BAR CODE TOP	TYPE	LENGTH
Item-number	N	8
Plant-code	N	2
Sequence-number	X	3
Quantity	N	8
Total length	-	21
SHORT BAR CODE BOTTOM	TYPE	LENGTH
Selection-code	X	3
Data-code	N	3
Batch-number	X	10
Filter	-	1
Total length	-	17

**DRY PACKING**

The reel is packed in an anti-humidity bag to protect the devices from absorbing moisture during transportation and storage.



**FINAL PACKING**

The sealed reel is packed into a cardboard box. A secondary cardboard box is used for shipping purposes.

**RECOMMENDED METHOD OF STORAGE**

Dry box storage is recommended as soon as the aluminum bag has been opened to prevent moisture absorption. The following conditions should be observed, if dry boxes are not available:

- Storage temperature 10 °C to 30 °C
- Storage humidity ≤ 60 % RH max.

After more than 72 h under these conditions moisture content will be too high for reflow soldering.

In case of moisture absorption, the devices will recover to the former condition by drying under the following condition:  
 192 h at 40 °C + 5 °C/- 0 °C and < 5 % RH (dry air/nitrogen) or  
 96 h at 60 °C + 5 °C and < 5 % RH for all device containers or  
 24 h at 125 °C + 5 °C not suitable for reel or tubes.

An EIA JEDEC standard JSTD-020 level 4 label is included on all dry bags.

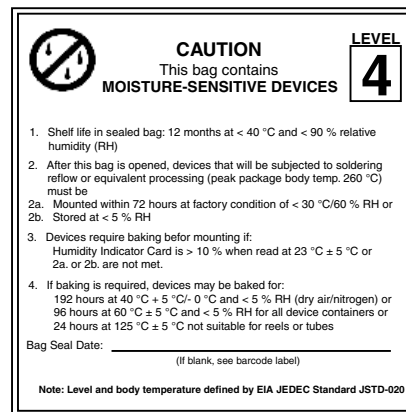

EIA JEDEC standard JSTD-020 level 4 label is included on all dry bags



**ESD PRECAUTION**

Proper storage and handling procedures should be followed to prevent ESD damage to the devices especially when they are removed from the antistatic shielding bag. Electro-static sensitive devices warning labels are on the packaging.

**VISHAY SEMICONDUCTORS STANDARD BAR CODE LABELS**

The Vishay Semiconductors standard bar code labels are printed at final packing areas. The labels are on each packing unit and contain Vishay Semiconductors specific data.



16962



## Disclaimer

ALL PRODUCT, PRODUCT SPECIFICATIONS AND DATA ARE SUBJECT TO CHANGE WITHOUT NOTICE TO IMPROVE RELIABILITY, FUNCTION OR DESIGN OR OTHERWISE.

Vishay Intertechnology, Inc., its affiliates, agents, and employees, and all persons acting on its or their behalf (collectively, "Vishay"), disclaim any and all liability for any errors, inaccuracies or incompleteness contained in any datasheet or in any other disclosure relating to any product.

Vishay makes no warranty, representation or guarantee regarding the suitability of the products for any particular purpose or the continuing production of any product. To the maximum extent permitted by applicable law, Vishay disclaims (i) any and all liability arising out of the application or use of any product, (ii) any and all liability, including without limitation special, consequential or incidental damages, and (iii) any and all implied warranties, including warranties of fitness for particular purpose, non-infringement and merchantability.

Statements regarding the suitability of products for certain types of applications are based on Vishay's knowledge of typical requirements that are often placed on Vishay products in generic applications. Such statements are not binding statements about the suitability of products for a particular application. It is the customer's responsibility to validate that a particular product with the properties described in the product specification is suitable for use in a particular application. Parameters provided in datasheets and/or specifications may vary in different applications and performance may vary over time. All operating parameters, including typical parameters, must be validated for each customer application by the customer's technical experts. Product specifications do not expand or otherwise modify Vishay's terms and conditions of purchase, including but not limited to the warranty expressed therein.

Except as expressly indicated in writing, Vishay products are not designed for use in medical, life-saving, or life-sustaining applications or for any other application in which the failure of the Vishay product could result in personal injury or death. Customers using or selling Vishay products not expressly indicated for use in such applications do so at their own risk and agree to fully indemnify and hold Vishay and its distributors harmless from and against any and all claims, liabilities, expenses and damages arising or resulting in connection with such use or sale, including attorneys fees, even if such claim alleges that Vishay or its distributor was negligent regarding the design or manufacture of the part. Please contact authorized Vishay personnel to obtain written terms and conditions regarding products designed for such applications.

No license, express or implied, by estoppel or otherwise, to any intellectual property rights is granted by this document or by any conduct of Vishay. Product names and markings noted herein may be trademarks of their respective owners.

## Material Category Policy

**Vishay Intertechnology, Inc. hereby certifies that all its products that are identified as RoHS-Compliant fulfill the definitions and restrictions defined under Directive 2011/65/EU of The European Parliament and of the Council of June 8, 2011 on the restriction of the use of certain hazardous substances in electrical and electronic equipment (EEE) - recast, unless otherwise specified as non-compliant.**

**Please note that some Vishay documentation may still make reference to RoHS Directive 2002/95/EC. We confirm that all the products identified as being compliant to Directive 2002/95/EC conform to Directive 2011/65/EU.**