

3rd. Over Tone Quartz Crystal Oscillator for 135MHz

■GENERAL DESCRIPTION

The NJU6397 series that is a C-MOS IC for quartz crystal oscillator consists of an oscillation amplifier and 3-state output buffer.

This series has three types of A, B and C. The frequency range of the A type is from 75 to 90MHz, and the B type is from 90 to 110MHz, and the C type is from 110 to 135MHz.

The oscillation amplifier realizes very low oscillation stop current with NAND circuit.

The 3-state output buffer is C-MOS compatible.

■PACKAGE OUTLINE



NJU6397XC-D

■FEATURES

- Operating Voltage 2.3 to 3.6V
- Maximum Oscillation Frequency (See Line-up Table)
- High Fan-out $I_{OH}/I_{OL} = 6mA @ V_{DD} = 2.5V$
 $I_{OH}/I_{OL} = 8mA @ V_{DD} = 3.3V$
- Oscillation Stop and Output Stand-by Function
- 3-State Output Buffer
- Oscillation Capacitors C_g and C_d on-chip
- Package Outline Thin-Chip
- C-MOS Technology

■PAD LOCATION

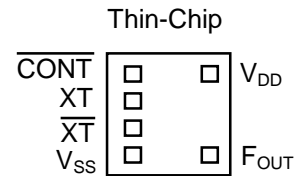

■LINE-UP TABLE

Type No.	Recommended Oscillation Frequency	Output Frequency	C_g/C_d
NJU6397	A	75 to 90MHz	11/12pF
	B	90 to 110MHz	9/10pF
	C	110 to 135MHz	8/9pF

■COORDINATES

No	Pad Name	X	Y
1	CONT	-178	231
2	XT	-178	77
3	XT	-178	-77
4	V_{SS}	-178	-231
5	F_{OUT}	206	-231
8	V_{DD}	206	231

Starting Point: Chip Center Unit[um]
 Chip Size: 0.7x0.75mm
 Thin-Chip Thickness: 200±20um
 Pad Size: 90x90um

■BLOCK DIAGRAM

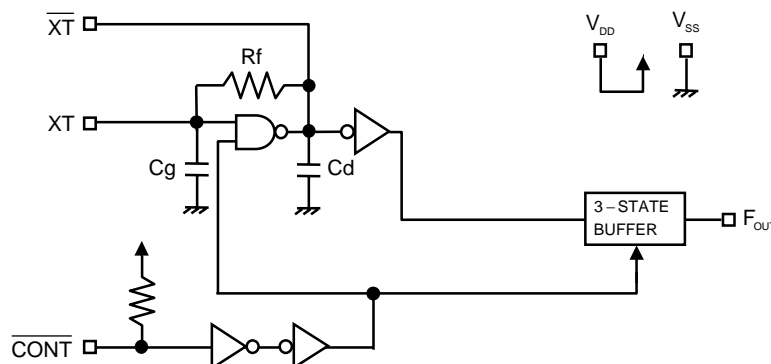

■TERMINAL DESCRIPTION

SYMBOL	FUNCTION	
$\overline{\text{CONT}}$	Oscillation and 3-state Output Buffer Control	
	$\overline{\text{CONT}}$	F_{OUT}
	H or OPEN	Output frequency f_0
	L	Oscillation Stop and High impedance Output
$\overline{\text{XT}}$	Quartz Crystal Connecting Terminals	
$\overline{\text{XT}}$		
V_{SS}	$V_{\text{SS}}=0\text{V}$	
F_{OUT}	Frequency Output	
V_{DD}	$V_{\text{DD}}=2.5\text{V}/3.3\text{V}$	

■ABSOLUTE MAXIMUM RATINGS

($T_a=25^\circ\text{C}$)

PARAMETER	SYMBOL	RATING	UNIT
Supply Voltage	V_{DD}	-0.5 to +7.0	V
Input Voltage	V_{IN}	$V_{\text{SS}}-0.5$ to $V_{\text{DD}}+0.5$	V
Output Voltage	V_{O}	-0.5 to $V_{\text{DD}}+0.5$	V
Input Current	I_{IN}	± 10	mA
Output Current	I_{O}	± 25	mA
Operating Temperature Range	T_{opr}	-40 to +85	$^\circ\text{C}$
Storage Temperature Range	T_{stg}	-55 to +125	$^\circ\text{C}$

Note1) If the supply voltage(V_{DD}) is less than 7.0V, the input voltage do not over the V_{DD} level.

Note2) Decoupling capacitor should be connected between V_{DD} and V_{SS} due to the stabilized operation for the circuit.

ELECTRICAL CHARACTERISTICS

(Ta=25°C)

PARAMETER	SYMBOL	CONDITIONS	MIN	TYP	MAX	UNIT
Operating Voltage	V _{DD}		2.3		3.6	V

(V_{DD}=2.5V, Ta=25°C)

PARAMETER	SYMBOL	CONDITIONS	MIN	TYP	MAX	UNIT
Operating Current	I _{DD1}	A type, fosc=90MHz, C _L =15pF		10	20	mA
		B type, fosc=110MHz, C _L =15pF		10	20	
		C type, fosc=135MHz, C _L =15pF		15	30	
Oscillation Stopping Current	I _{DD2}	CONT=V _{SS} , No load		2	5	uA
Stand-by Current	I _{st}	CONT=XT=V _{SS} , No load Note3)			1	uA
Input Voltage	V _{IH}		2.0		3.5	V
	V _{IL}		0		0.5	V
Output Current	I _{OH}	V _{OH} =2.2V	6			mA
	I _{OL}	V _{OL} =0.3V	6			mA
Input Current	I _{IN}	CONT=0.8V _{DD}		7.5	12.0	uA
		CONT=0.2V _{DD}		1.2	2.0	uA
3-state Off Leakage Current	I _{oz}	CONT=V _{SS} , F _{OUT} = V _{DD} or V _{SS}			±0.1	uA
Feedback Resistance	R _f	A type		3.8		kΩ
		B type		3.8		
		C type		2.9		
Internal Capacitor	C _g /C _d	A type, fosc=90MHz		11/12		pF
		B type, fosc=110MHz		9/10		
		C type, fosc=135MHz		8/9		
Maximum Oscillation Frequency	F _{MAX}	A type	90			MHz
		B type	110			
		C type	135			
Output Signal Symmetry	SYM	C _L =15pF, @V _{DD} /2	45	50	55	%
Output Signal Rise Time	t _r	C _L =15pF, 10% to 90%		3	4	ns
Output Signal Fall Time	t _f	C _L =15pF, 90% to 10%		3	4	ns
Output Disable time	T _{PLZ}	C _L =15pF, R _{UP} =10kΩ			200	ns
Output Enable Time	T _{PZL}	C _L =15pF, R _{UP} =10kΩ			200	ns

Note3) Excluding input current on CONT Terminal.

($V_{DD}=3.3V, T_a=25^{\circ}C$)

PARAMETER	SYMBOL	CONDITIONS	MIN	TYP	MAX	UNIT
Operating Current	I_{DD1}	A type, fosc=90MHz, $C_L=15pF$		13	25	mA
		B type, fosc=110MHz, $C_L=15pF$		13	25	
		C type, fosc=135MHz, $C_L=15pF$		18	35	
Oscillation Stopping Current	I_{DD2}	$\overline{CONT}=V_{SS}$, No load			10	μA
Stand-by Current	I_{st}	$\overline{CONT}=XT=V_{SS}$, No load Note3)			1	μA
Input Voltage	V_{IH}		2.3		3.3	V
	V_{IL}		0		1.0	V
Output Current	I_{OH}	$V_{OH}=2.97V$	8			mA
	I_{OL}	$V_{OL}=0.33V$	8			mA
Input Current	I_{IN}	$\overline{CONT}=0.8V_{DD}$		10.0	15.0	μA
		$\overline{CONT}=0.2V_{DD}$		1.8	3.0	μA
3-state Off Leakage Current	I_{OZ}	$\overline{CONT}=V_{SS}$, $F_{OUT}=V_{DD}$ or V_{SS}			± 0.1	μA
Feedback Resistance	R_f	A type		3.8		k Ω
		B type		3.8		
		C type		2.9		
Internal Capacitor	C_g/C_d	A type, fosc=90MHz		11/12		pF
		B type, fosc=110MHz		9/10		
		C type, fosc=135MHz		8/9		
Maximum Oscillation Frequency	F_{MAX}	A type	90			MHz
		B type	110			
		C type	135			
Output Signal Symmetry	SYM	$C_L=15pF$, @ $V_{DD}/2$	45	50	55	%
Output Signal Rise Time	tr	$C_L=15pF$, 10% to 90%		2	3	ns
Output Signal Fall Time	tf	$C_L=15pF$, 90% to 10%		2	3	ns
Output Disable time	T_{PLZ}	$C_L=15pF$, $R_{UP}=10k\Omega$			150	ns
Output Enable Time	T_{PZL}	$C_L=15pF$, $R_{UP}=10k\Omega$			150	ns

Note3) Excluding input current on CONT Terminal.

MEASUREMENT CIRCUITS

(1) Output Signal Symmetry ($C_L=15\text{pF}$)

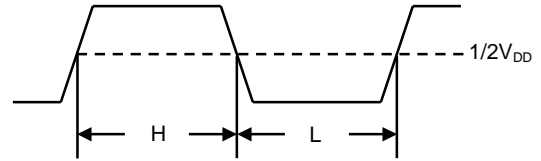
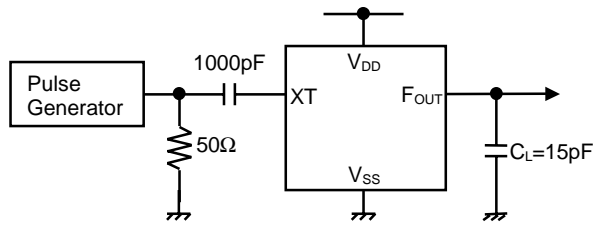

(2) Output Signal Rise/Fall Time ($C_L=15\text{pF}$)

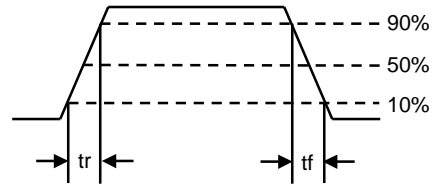
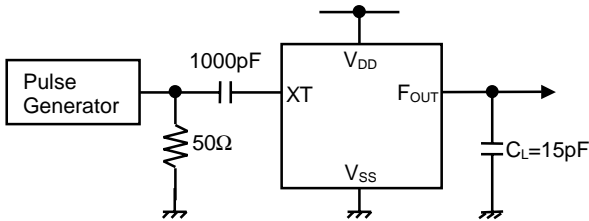

(3) Output Disable/Enable Time ($C_L=15\text{pF}, R_{UP}=10\text{k}\Omega$)

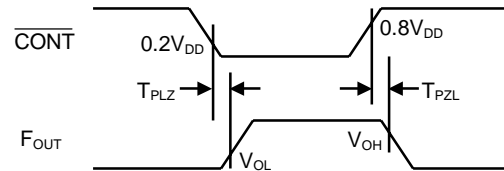
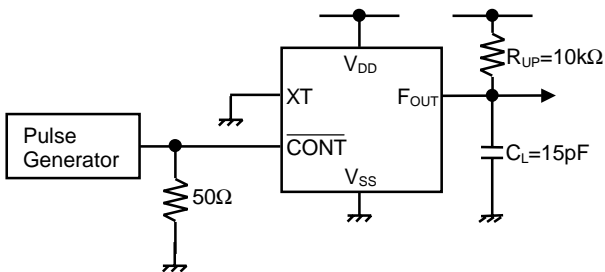

[CAUTION]
 The specifications on this data book are only given for information, without any guarantee as regards either mistakes or omissions. The application circuits in this data book are described only to show representative usages of the product and not intended for the guarantee or permission of any right including the industrial rights.