

## Dual Operational Comparator

# LM358QN

### Description

The LM358QN consists of two independent high gain, internally frequency compensated operational amplifier. It can be operated from a single power supply and also split power supplies.

### Features

- Internally frequency compensated for unity gain
- Single supply operation:3V to 32V
- Input common-mode voltage range includes ground
- Large DC voltage gain

### Applications

- General purpose amplifier
- Transducer amplifier

### Pin Configurations

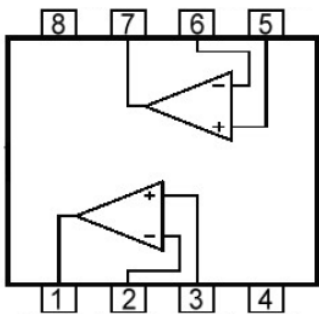
	Pin1: OUTPUT 1	Pin5: INPUT 2 (+)
	Pin2: INPUT 1 (-)	Pin6: INPUT 2 (-)
	Pin3: INPUT 1 (+)	Pin7: OUTPUT 2
	Pin4: Gnd/VEE	Pin8: VCC



**Absolute Maximum Rating(Ta=25°C)**

Parameter	Symbol	Value	Unit
Supply Voltage	V <sub>CC</sub>	±16 or 32	V
Input Differential Voltage Range	V <sub>I(DIFF)</sub>	±32	V
Input Common Mode Voltage Range	V <sub>ICR</sub>	-0.3 ~ +32	V
Output Short Circuit Duration	t <sub>SC</sub>	Continuous	
Operating Temperature	T <sub>opr</sub>	0 ~ +70	°C
Storage Temperature	T <sub>stg</sub>	-65 ~ +150	°C

**Electrical Characteristics** (V<sub>CC</sub>=5V, Ta=25°C, V<sub>EE</sub>=GND, unless otherwise specified.)

Parameter	Test Condition	Symbol	Min.	Typ.	Max.	Unit
Input Offset Voltage	V <sub>CM</sub> =0 to V <sub>CC</sub> -1.5V V <sub>O(p)</sub> =1.4V, R <sub>S</sub> =0	V <sub>IO</sub>	-	2.9	7.0	mV
Input Offset Current		I <sub>IO</sub>	-	5	50	nA
Input Bias Current		I <sub>IB</sub>	-	45	250	nA
Input Common-Mode Voltage	V <sub>CC</sub> =30V	V <sub>ICR</sub>	0	-	V <sub>CC</sub> -1.5	V
Power Supply Current	R <sub>L</sub> =∞, V <sub>CC</sub> =5V, V <sub>O</sub> =0V	I <sub>CC</sub>	-	0.5	1.2	mA
	R <sub>L</sub> =∞, V <sub>CC</sub> =30V, V <sub>O</sub> =0V		-	0.8	2.0	mA
Large Signal Voltage Gain	V <sub>CC</sub> =15V, R <sub>L</sub> ≥2kΩ V <sub>O(p)</sub> =1V to 11V	G <sub>v</sub>	25	100	-	V/mV
Output Voltage-High Limit	V <sub>CC</sub> =30V, R <sub>L</sub> =2kΩ	V <sub>O(H)</sub>	26	-	-	V
	V <sub>CC</sub> =30V, R <sub>L</sub> =10kΩ		27	28	-	
Output Voltage-Low Limit	V <sub>CC</sub> =5V, R <sub>L</sub> ≥10kΩ	V <sub>O(L)</sub>	-	5	20	mV
Common Mode Rejection Ratio		CMRR	65	80	-	dB
Power Supply Rejection Ratio		PSRR	65	100	-	dB
Channel Separation	f=1kHz to 20kHz	CS	-	120	-	dB
Short Circuit Current to Ground		I <sub>SC</sub>	-	40	60	mA
Output Source Current	V <sub>i(+)</sub> =1V, V <sub>i(-)</sub> =0V, V <sub>CC</sub> =15V, V <sub>O(p)</sub> =2V	I <sub>source</sub>	10	30	-	mA
Output Sink Current	V <sub>i(+)</sub> =0V, V <sub>i(-)</sub> =1V, V <sub>CC</sub> =15V, V <sub>O(p)</sub> =2V	I <sub>sink</sub>	10	15	-	mA
	V <sub>i(+)</sub> =0V, V <sub>i(-)</sub> =1V, V <sub>CC</sub> =15V, V <sub>O(p)</sub> =0.2V		12	100	-	μA
Differential Input Voltage		V <sub>I(DIFF)</sub>	-	-	V <sub>CC</sub>	V

**Block Diagram**

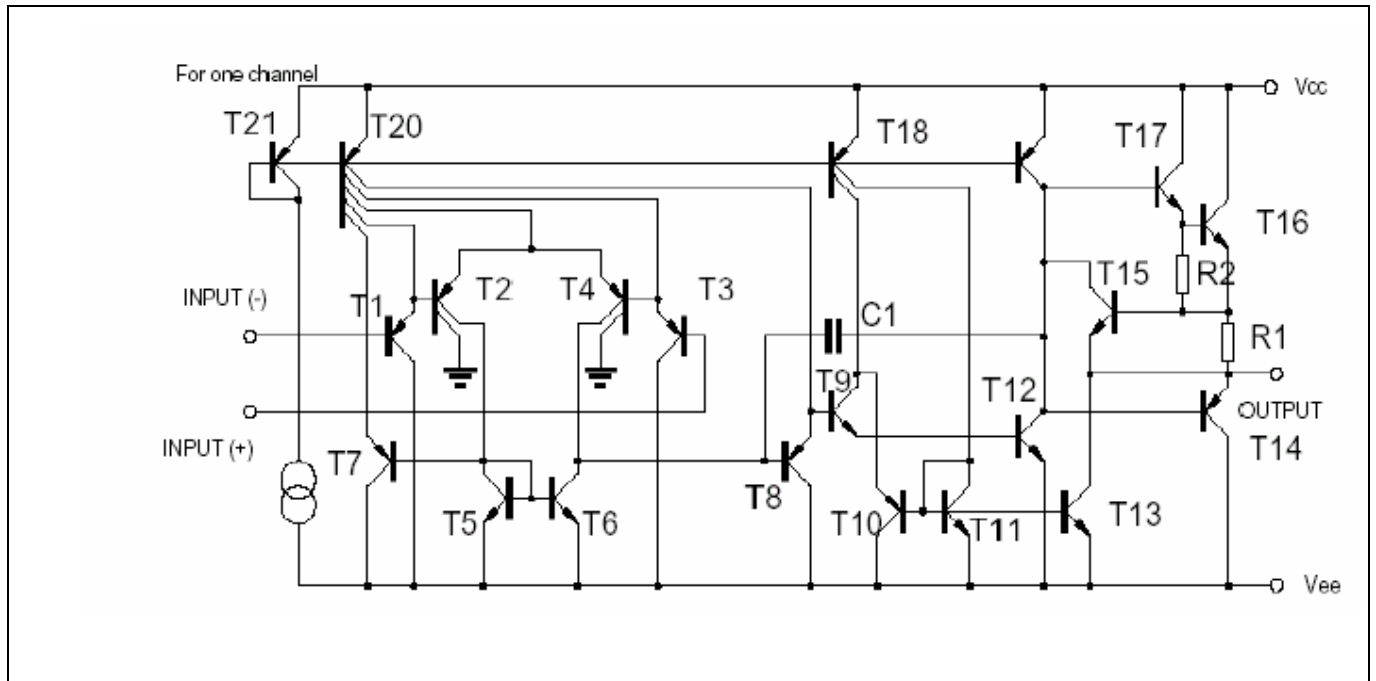

**Characteristic Curves**

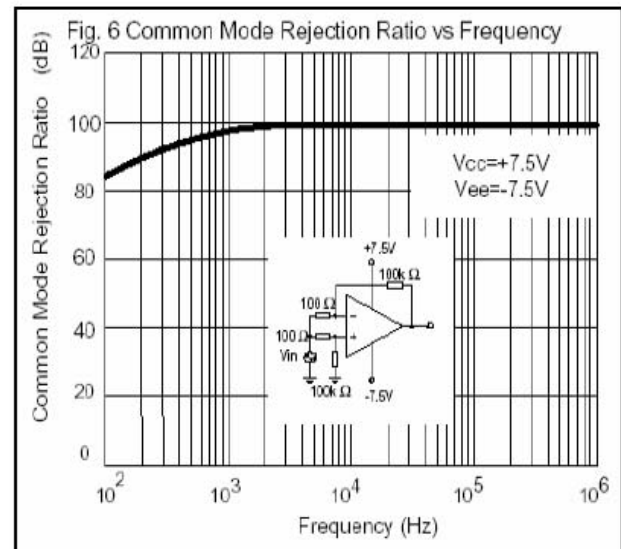
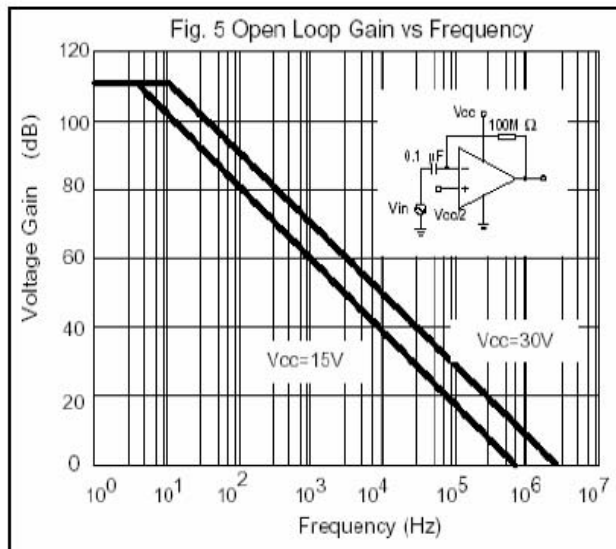
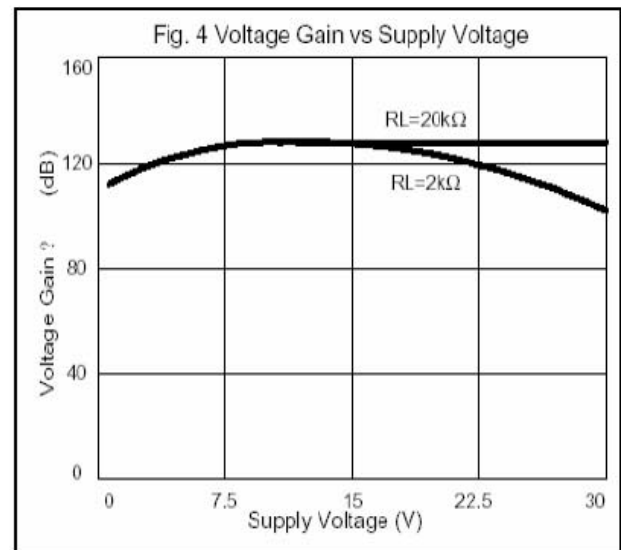
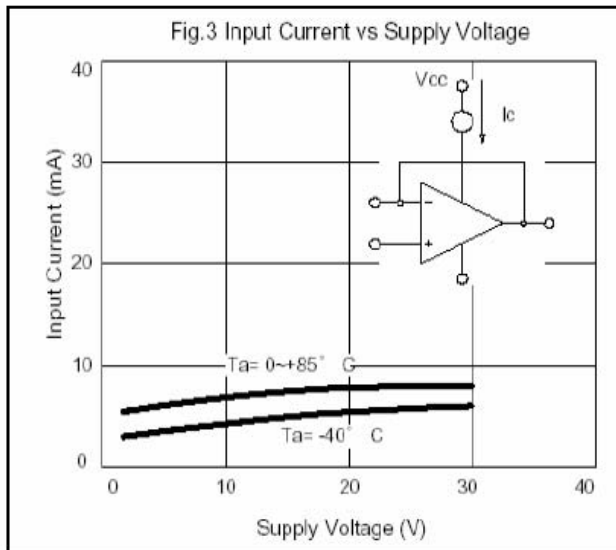
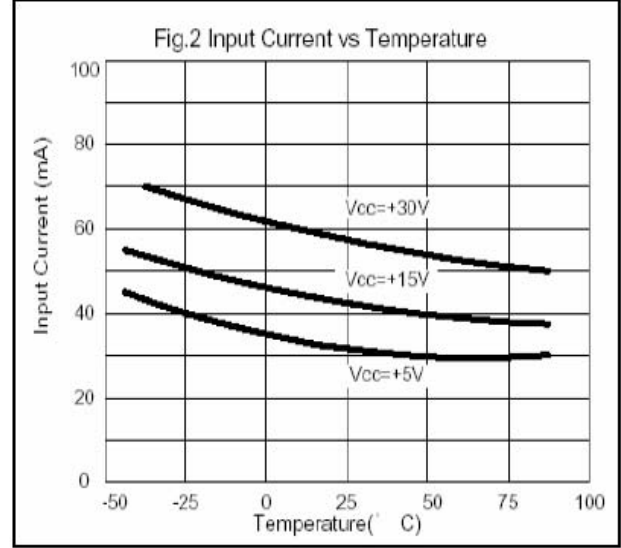
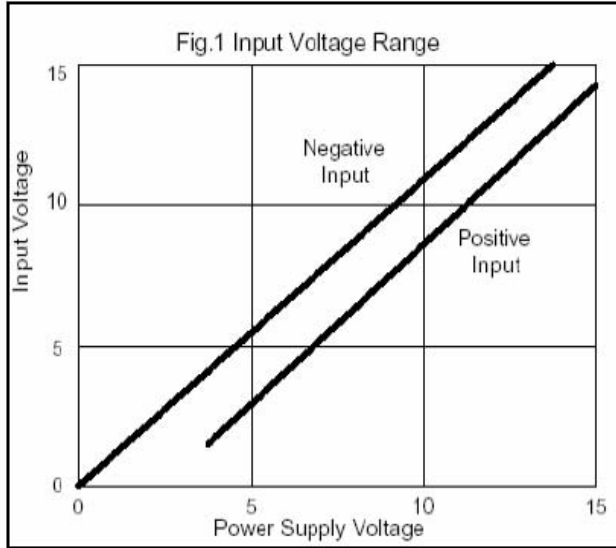

**Characteristic Curves(Cont.)**

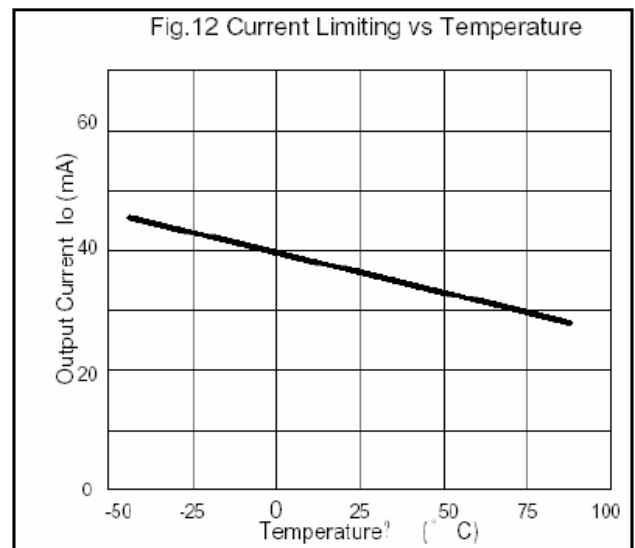
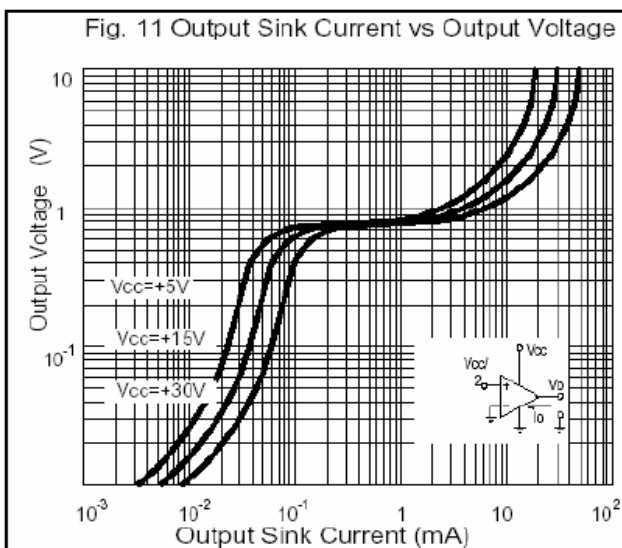
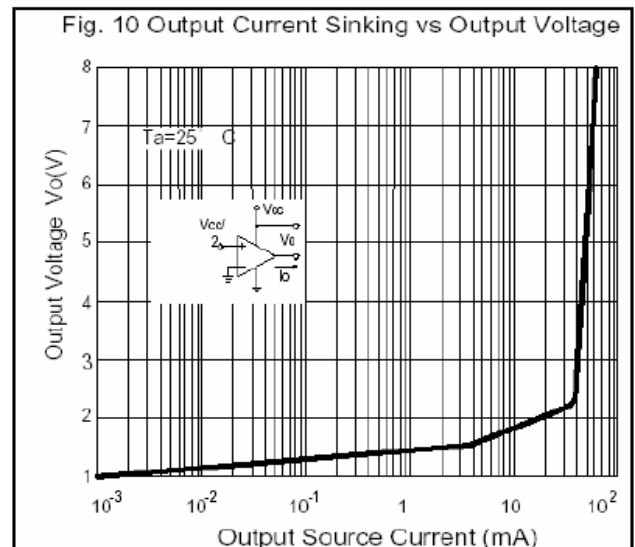
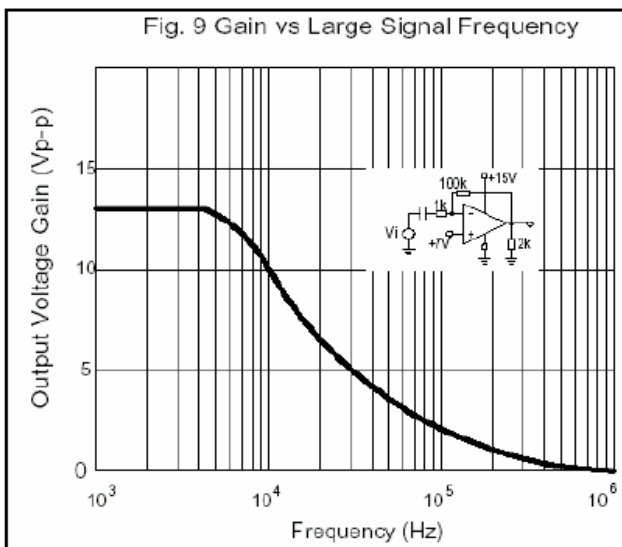
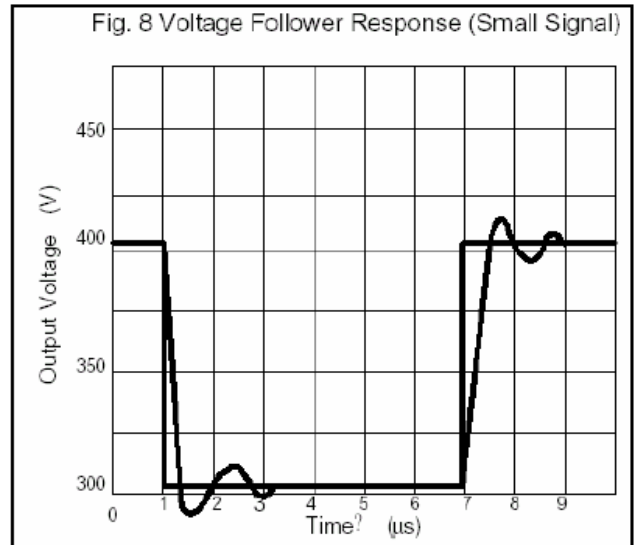
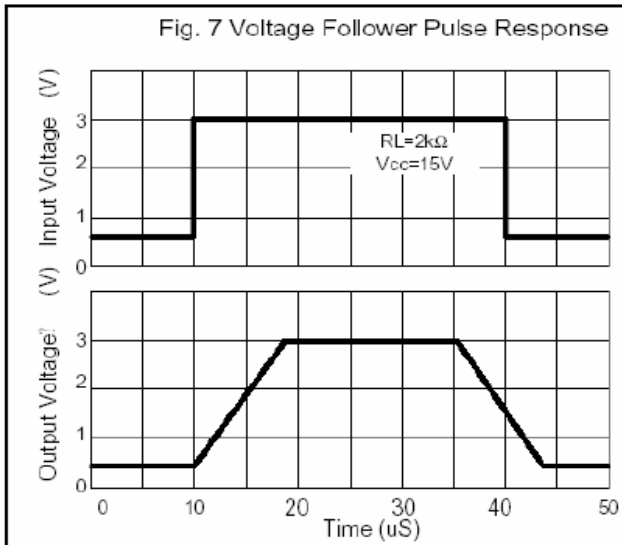

**MSOP-8 Dimension**

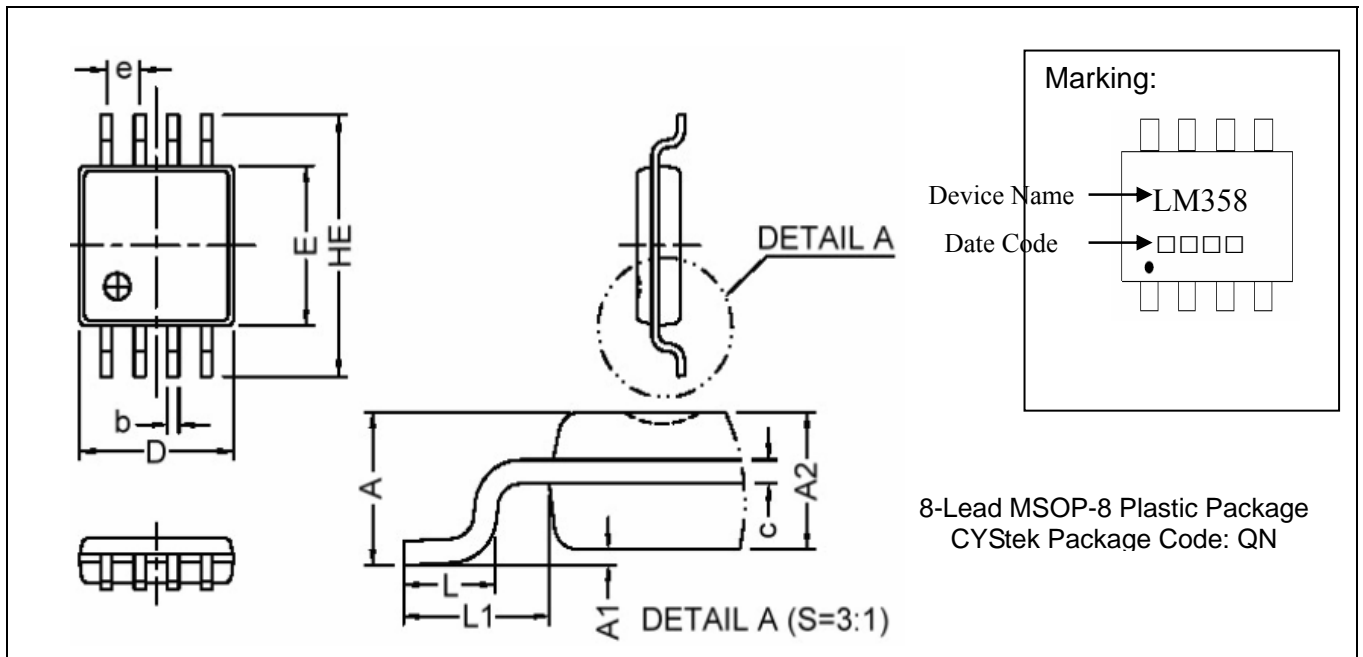

\*: Typical

DIM	Inches		Millimeters		DIM	Inches		Millimeters	
	Min.	Max.	Min.	Max.		Min.	Max.	Min.	Max.
A	-	0.043	-	1.10	L	0.016	0.028	0.40	0.70
A1	0.002	0.006	0.05	0.15	L1	0.037 BSC		0.95 BSC	
A2	0.031	0.037	0.78	0.94	b	0.009	0.015	0.22	0.38
D	0.114	0.122	2.90	3.10	c	0.003	0.009	0.08	0.23
E	0.114	0.122	2.90	3.10	e	0.026 BSC		0.65 BSC	
HE	0.187	0.199	4.75	5.05					

Notes: 1. Controlling dimension: millimeters.  
 2. Maximum lead thickness includes lead finish thickness, and minimum lead thickness is the minimum thickness of base material.  
 3. If there is any question with packing specification or packing method, please contact your local CYStek sales office.

**Material:**

- Lead: Pure tin plated.
- Mold Compound: Epoxy resin family, flammability solid burning class: UL94V-0.

**Important Notice:**

- All rights are reserved. Reproduction in whole or in part is prohibited without the prior written approval of CYStek.
- CYStek reserves the right to make changes to its products without notice.
- CYStek **semiconductor products are not warranted to be suitable for use in Life-Support Applications, or systems.**
- CYStek assumes no liability for any consequence of customer product design, infringement of patents, or application assistance.