

DIGITRON SEMICONDUCTORS

MPU131-MPU133

PROGRAMMABLE UNIJUNCTION TRANSISTORS

Available Non-RoHS (standard) or RoHS compliant (add PBF suffix).

Available as "HR" (high reliability) screened per MIL-PRF-19500, JANTX level. Add "HR" suffix to base part number.

MAXIMUM RATINGS

Rating	Symbol	Value	Unit
Power dissipation	P_F	375	mW
Derate above 25°C	$1/\theta_{JA}$	5.0	mW/°C
DC forward anode current	I_T	200	mA
Derate above 25°C		2.67	mA/°C
DC gate current	I_G	±20	mA
Repetitive peak forward current	I_{TRM}	1.0	Amp
100µs pulse width, 1.0% duty cycle		2.0	
20µs pulse width, 1.0% duty cycle			
Non-repetitive peak forward current	I_{TSM}	5.0	Amp
10µs pulse width			
Gate to cathode forward voltage	V_{GKF}	40	Volts
Gate to cathode reverse voltage	V_{GKR}	5.0	Volts
Gate to anode reverse voltage	V_{GAR}	40	Volts
Anode to cathode voltage	V_{AK}	±40	Volts
Operating junction temperature range	T_J	-50 to 100	°C
Storage temperature range	T_{stg}	-65 to 150	°C

ELECTRICAL CHARACTERISTICS ($T_A = 25^\circ\text{C}$ unless otherwise noted)

Characteristic		Symbol	Min	Typ	Max	Unit
Peak current ($V_S = 10\text{Vdc}$, $R_G = 1.0\text{M}\Omega$)	MPU131	I_P	-	1.25	2.0	μA
	MPU132		-	0.19	0.30	
	MPU133		-	0.08	0.15	
($V_S = 10\text{Vdc}$, $R_G = 10\text{k}\Omega$)	MPU131		-	4.0	5.0	
	MPU132		-	1.20	2.0	
	MPU133		-	0.70	1.0	
Off set voltage ($V_S = 10\text{Vdc}$, $R_G = 1.0\text{M}\Omega$)	MPU131	V_T	0.2	0.70	1.6	Volts
	MPU132		0.2	0.50	0.6	
	MPU133 (all types)		0.2	0.40	0.6	
($V_S = 10\text{Vdc}$, $R_G = 10\text{k}\Omega$)			0.2	0.35	0.6	
Valley current ($V_S = 10\text{Vdc}$, $R_G = 1.0\text{M}\Omega$)	MPU131, MPU132	I_V	-	18	50	μA
	MPU133		-	18	25	
($V_S = 10\text{Vdc}$, $R_G = 10\text{k}\Omega$)	MPU131		70	270	-	
	MPU132, MPU133		50	270	-	
Gate to anode leakage current ($V_S = 40\text{Vdc}$, $T_A = 25^\circ\text{C}$, cathode open)		I_{GAO}	-	1.0	5.0	nAdc
($V_S = 40\text{Vdc}$, $T_A = 75^\circ\text{C}$, cathode open)			-	30	75	
Gate to cathode leakage current ($V_S = 40\text{Vdc}$, anode to cathode shorted)		I_{GKS}	-	5.0	50	nAdc
Forward voltage ($I_F = 50\text{mA}$ peak)		V_F	-	0.8	1.5	Volts
Peak output voltage ($V_B = 20\text{Vdc}$, $C_C = 0.2\mu\text{F}$)		V_O	6.0	11	-	Volts
Pulse voltage rise time ($V_B = 20\text{Vdc}$, $C_C = 0.2\mu\text{F}$)		t_r	-	40	80	ns

DIGITRON SEMICONDUCTORS

MPU131-MPU133

PROGRAMMABLE UNIJUNCTION TRANSISTORS

MECHANICAL CHARACTERISTICS

Case	TO-92
Marking	Body painted, alpha-numeric
Pin out	See below

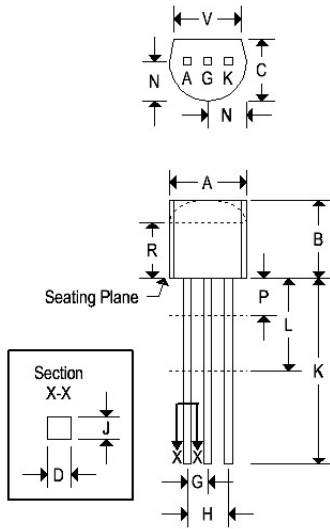

Dim	TO-92			
	Inches		Millimeters	
	Min	Max	Min	Max
A	0.175	0.205	4.450	5.200
B	0.170	0.210	4.320	5.330
C	0.125	0.165	3.180	4.190
D	0.016	0.021	0.407	0.533
G	0.045	0.055	1.150	1.390
H	0.095	0.105	2.420	2.660
J	0.015	0.020	0.390	0.500
K	0.500	-	12.700	-
L	0.250	-	6.350	-
N	0.080	0.105	2.040	2.660
P	-	0.100	-	2.540
R	0.115	-	2.930	-
V	0.135	-	3.430	-

ELECTRICAL CHARACTERIZATION

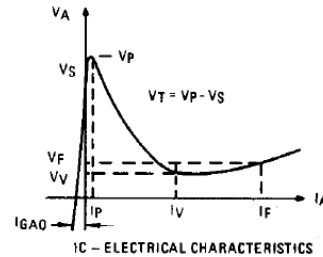
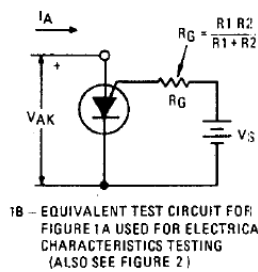
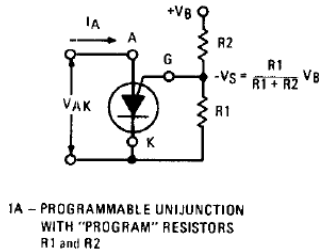

PEAK CURRENT (I_p) TEST CIRCUIT

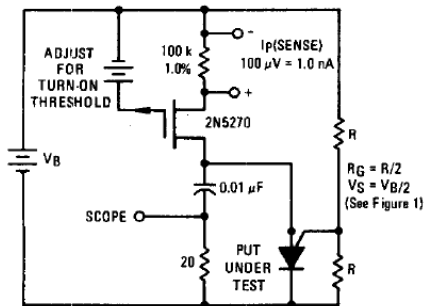

V_0 AND t_r TEST CIRCUIT

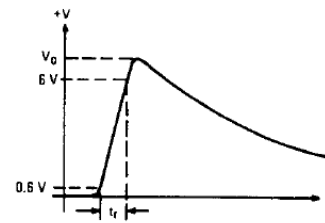
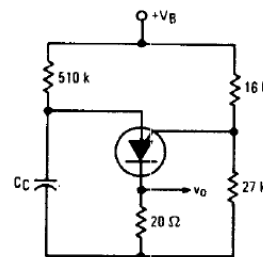

DIGITRON SEMICONDUCTORS

MPU131-MPU133 PROGRAMMABLE UNIJUNCTION TRANSISTORS

EFFECT OF SUPPLY VOLTAGE

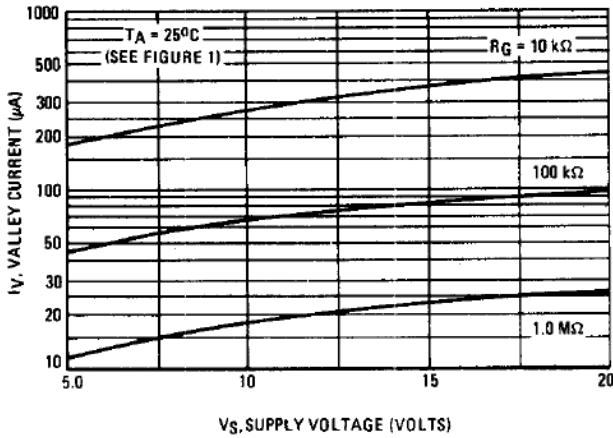

EFFECT OF TEMPERATURE

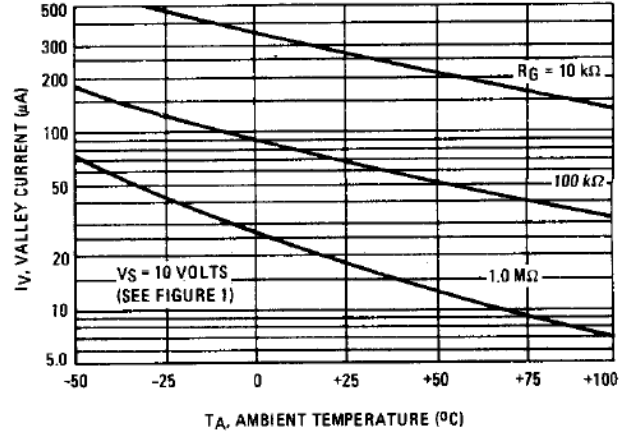

FORWARD VOLTAGE

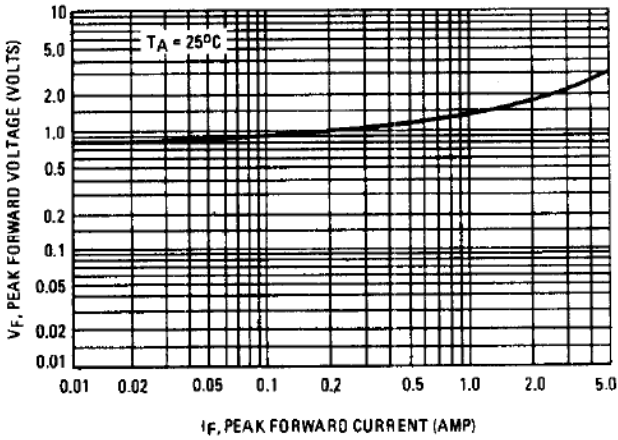

PEAK OUTPUT VOLTAGE

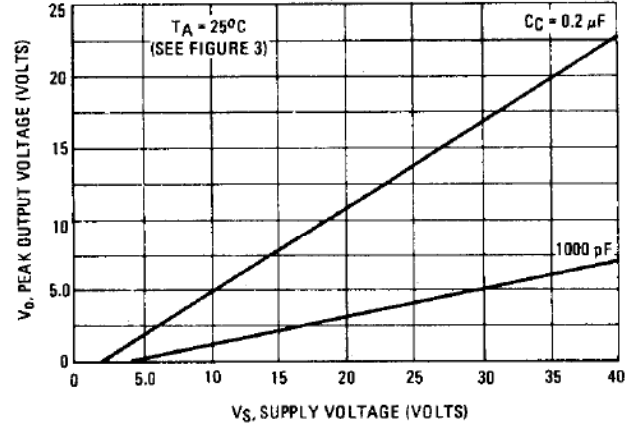

STANDARD UNIJUNCTION COMPARED TO PROGRAMMABLE UNIJUNCTION

STANDARD UNIJUNCTION

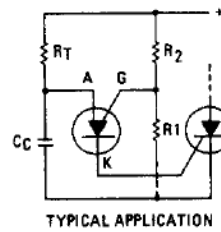
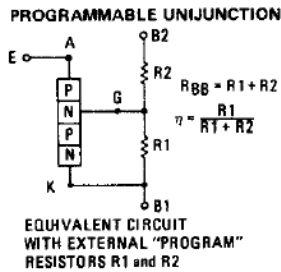
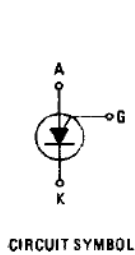
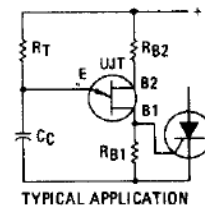
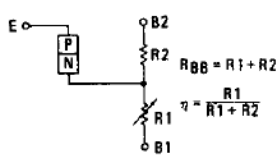
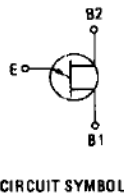

DIGITRON SEMICONDUCTORS

MPU131-MPU133 PROGRAMMABLE UNIJUNCTION TRANSISTORS

TYPICAL PEAK CURRENT BEHAVIOR

MPU131

EFFECT OF SUPPLY VOLTAGE AND R_G

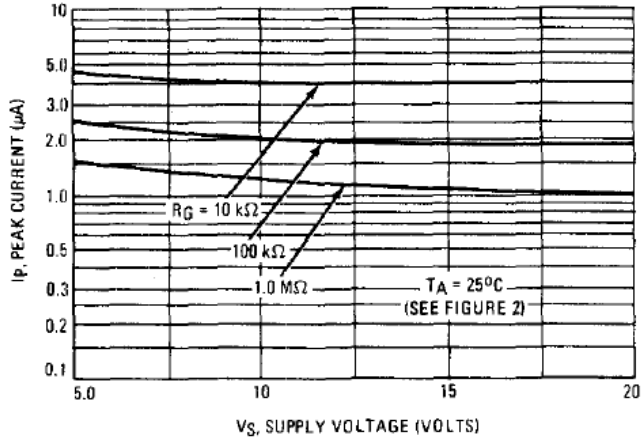

EFFECT OF TEMPERATURE AND R_G

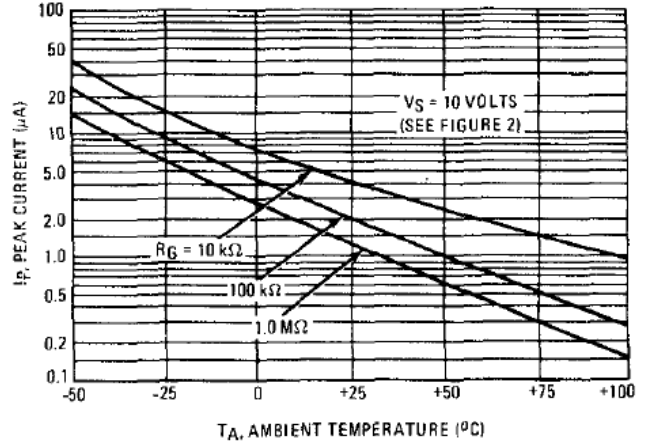

MPU132

EFFECT OF SUPPLY VOLTAGE AND R_G

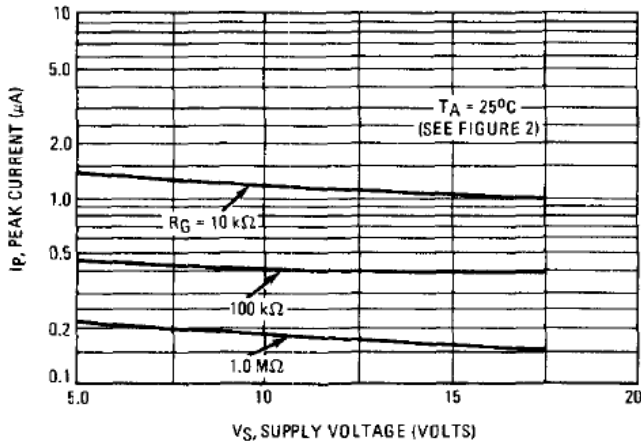

EFFECT OF TEMPERATURE AND R_G

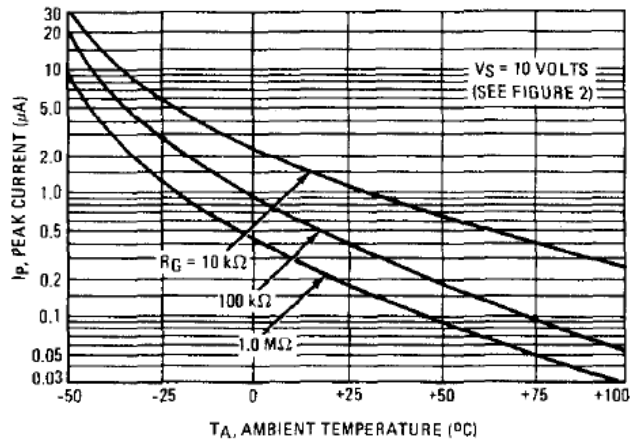

MPU133

EFFECT OF SUPPLY VOLTAGE AND R_G

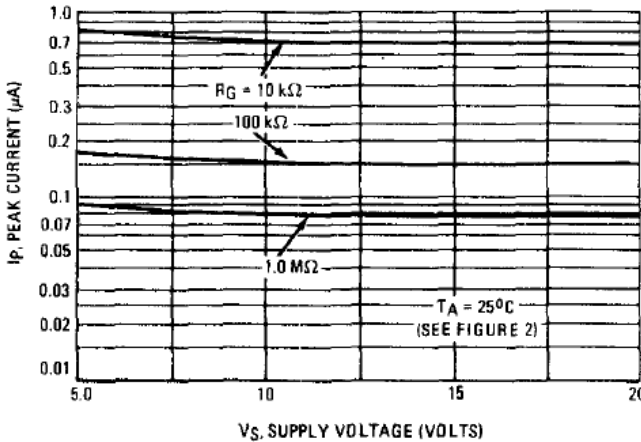

EFFECT OF TEMPERATURE AND R_G

