

NCP4543

ecoSwitch™ Advanced Load Management Controlled Load Switch with Low R_{ON}

The NCP4543 load switch provides a component and area-reducing solution for efficient power domain switching with inrush current limit via soft start. It is designed to integrate control and driver functionality with a high performance low on-resistance power MOSFET in a single device. This cost effective solution is ideal for power management and hot-swap applications requiring low power consumption in a small footprint.

Features

- Advanced Controller with Charge Pump
- Integrated N-Channel MOSFET with ESD Protection
- Soft-Start via Adjustable Slew Rate Control
- Low On-Resistance
- Input Voltage Range 0.5 V to 6 V
- Low Standby Current
- Load Bleed Function
- No External Components Required
- Enable Pins with CMOS Input Levels
- This is a Pb-Free Device

Typical Applications

- Notebook and Tablet Computers
- Handheld Electronics
- Digital Cameras
- Portable Medical Devices
- Hard Drives
- Peripheral Ports

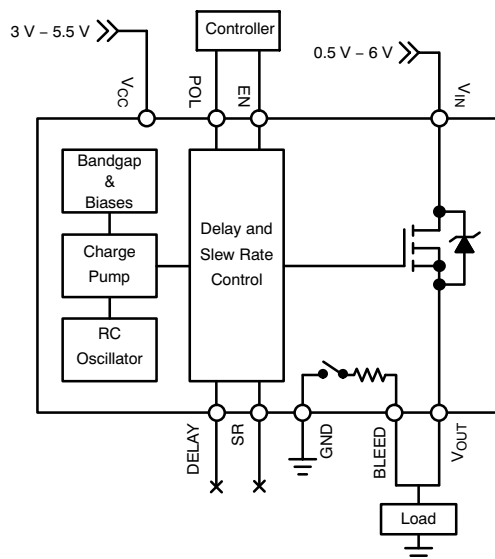

Figure 1. Typical Application – No external components included



ON Semiconductor®

<http://onsemi.com>

R _{ON} TYP	V _{CC}	V _{IN}	I _{MAX}
10.2 mΩ	5.0 V	1.8 V	7.3 A
12.2 mΩ	3.3 V	5.0 V	



QFN18, 3x3
CASE 485BF

MARKING DIAGRAM

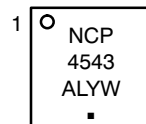

- A = Assembly Location
- L = Wafer Lot
- Y = Year
- W = Work Week
- = Pb-Free Package

PIN CONFIGURATION

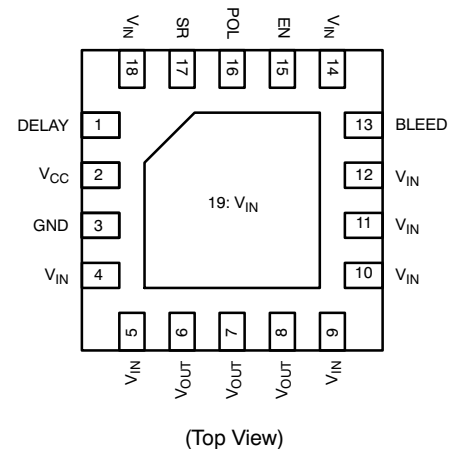

ORDERING INFORMATION

Device	Package	Shipping†
NCP4543IMN5RG-A	QFN18 (Pb-Free)	3000 / Tape & Reel

†For information on tape and reel specifications, including part orientation and tape sizes, please refer to our Tape and Reel Packaging Specifications Brochure, BRD8011/D.

NCP4543

PIN DESCRIPTION

Pin	Name	Function															
1	DELAY	Turn-on delay adjustment															
2	V _{CC}	Supply voltage to controller (3.0 V – 5.5 V)															
3	GND	Controller ground															
4, 5, 9–12, 14, 18, 19	V _{IN}	Drain of MOSFET (0.5 V – 6.0 V)															
6–8	V _{OUT}	Source of MOSFET connected to load															
13	BLEED	Load bleed connection															
15	EN	Digital input used to turn on the MOSFET according to this truth table: <table border="1" style="margin-left: 20px;"> <thead> <tr> <th>EN</th> <th>POL</th> <th>MOSFET</th> </tr> </thead> <tbody> <tr> <td>0</td> <td>0</td> <td>On</td> </tr> <tr> <td>0</td> <td>1</td> <td>Off</td> </tr> <tr> <td>1</td> <td>0</td> <td>Off</td> </tr> <tr> <td>1</td> <td>1</td> <td>On</td> </tr> </tbody> </table>	EN	POL	MOSFET	0	0	On	0	1	Off	1	0	Off	1	1	On
EN	POL	MOSFET															
0	0	On															
0	1	Off															
1	0	Off															
1	1	On															
16	POL	EN has an internal pull down resistor to GND POL has an internal pull up resistor to V _{CC}															
17	SR	Slew rate adjustment															

ABSOLUTE MAXIMUM RATINGS

Rating	Symbol	Value	Unit
Supply Voltage Range	V _{CC}	–0.3 to 6	V
Input Voltage Range	V _{IN}	–0.3 to 6	V
Output Voltage Range	V _{OUT}	–0.3 to 6	V
EN/POL Digital Input Range	V _{EN}	–0.3 to (V _{CC} + 0.3)	V
Thermal Resistance, Junction-to-Air (Note 1)	R _{θJA}	49.5	°C/W
Thermal Resistance, Junction-to-Air (Note 2)	R _{θJA}	32.9	°C/W
Thermal Resistance, Junction-to-Case (V _{IN} Paddle)	R _{θJC}	3.6	°C/W
Continuous MOSFET Current (Note 3)	I _{MAX}	7.3	A
Total Power Dissipation @ T _A = 25°C (Notes 1 and 4) Derate above T _A = 25°C	P _D	1.31 20.2	W mW/°C
Total Power Dissipation @ T _A = 25°C (Notes 2 and 4) Derate above T _A = 25°C	P _D	1.98 30.4	W mW/°C
Storage Temperature Range	T _{STG}	–40 to 150	°C
Lead Temperature, Soldering (10 sec.)	T _{SLD}	260	°C
ESD Capability, Human Body Model (Note 5)	ESD _{HBM}	3.5	kV
ESD Capability, Machine Model (Note 5)	ESD _{MM}	200	V
ESD Capability, Charged Device Model (Note 5)	ESD _{CDM}	1	kV
Latch-up Current Immunity (Note 5)	LU	100	mA

Stresses exceeding Maximum Ratings may damage the device. Maximum Ratings are stress ratings only. Functional operation above the Recommended Operating Conditions is not implied. Extended exposure to stresses above the Recommended Operating Conditions may affect device reliability.

- Surface-mounted on FR4 board using the minimum recommended pad size, 1 oz Cu.
- Surface-mounted on FR4 board using 1 sq-in pad, 1 oz Cu.
- Current limited by package.
- Specified for derating purposes only, ensure that I_{MAX} is never exceeded.
- Tested by the following methods @ T_A = 25°C:
 ESD Human Body Model tested per AEC-Q100-002 (EIA/JESD22-A114)
 ESD Machine Model tested per EIA/JESD22-A115
 ESD Charged Device Model per ESD-STM5.3.1-1999
 Latch-up Current Maximum Rating: ≤100 mA per JEDEC standard: JESD78

NCP4543

OPERATING RANGES

Rating	Symbol	Min	Max	Unit
Supply Voltage	V_{CC}	3	5.5	V
Input Voltage	V_{IN}	0.5	6	V
Ground	GND		0	V
Ambient Temperature	T_A	0	70	°C
Junction Temperature	T_J	0	90	°C

ELECTRICAL CHARACTERISTICS ($T_J = 25^\circ\text{C}$ unless otherwise specified)

Parameter	Test Conditions	Symbol	Min	Typ	Max	Unit
MOSFET						
On-Resistance	$V_{CC} = 5.0\text{ V}; V_{IN} = 1.8\text{ V}$	R_{ON}		10.2	13	m Ω
	$V_{CC} = 5.0\text{ V}; V_{IN} = 5.0\text{ V}$			10.5	13.5	
	$V_{CC} = 3.3\text{ V}; V_{IN} = 1.8\text{ V}$			11	14	
	$V_{CC} = 3.3\text{ V}; V_{IN} = 5.0\text{ V}$			12.2	16	
Leakage Current (Note 6)	$V_{EN} = 0\text{ V}; V_{POL} = V_{CC}; V_{IN} = 6\text{ V}$	I_{LEAK}		0.02	1.0	μA

CONTROLLER

Supply Standby Current (Note 7)	$V_{EN} = 0\text{ V}; V_{POL} = V_{CC} = 5.5\text{ V}$	I_{STBY}		5.0	15	μA
Supply Dynamic Current (Note 8)	$V_{EN} = V_{POL} = V_{CC}$	I_{DYN}		250	500	μA
Bleed Resistance		R_{BLEED}	50	100	200	Ω
Input High Voltage – EN & POL		V_{IH}	2.0			V
Input Low Voltage – EN & POL		V_{IL}			0.8	V
Pull Down Resistance – EN		R_{PD}	40	100	180	k Ω
Pull Up Resistance – POL		R_{PU}	40	100	180	k Ω

6. Average current from V_{IN} to V_{OUT} with MOSFET turned off.
7. Average current from V_{CC} to GND with MOSFET turned off.
8. Average current from V_{CC} to GND after charge up time of MOSFET.

NCP4543

SWITCHING CHARACTERISTICS ($T_J = 25^\circ\text{C}$ unless otherwise specified, Note 9)

Parameter	Test Conditions	Symbol	Min	Typ	Max	Unit
-----------	-----------------	--------	-----	-----	-----	------

$V_{CC} = 5.0\text{ V}$, $V_{IN} = 1.8\text{ V}$

Output Slew Rate	$R_L = 10\ \Omega$, $C_L = 0.1\ \mu\text{F}$	SR		8.1		kV/s
Output Turn-on Delay	$R_L = 10\ \Omega$, $C_L = 0.1\ \mu\text{F}$	T_{ON}		540		μs
Output Turn-off Delay	$R_L = 10\ \Omega$, $C_L = 0.1\ \mu\text{F}$	T_{OFF}		1.2		μs

$V_{CC} = 3.3\text{ V}$, $V_{IN} = 5.0\text{ V}$

Output Slew Rate	$R_L = 10\ \Omega$, $C_L = 0.1\ \mu\text{F}$	SR		8.5		kV/s
Output Turn-on Delay	$R_L = 10\ \Omega$, $C_L = 0.1\ \mu\text{F}$	T_{ON}		670		μs
Output Turn-off Delay	$R_L = 10\ \Omega$, $C_L = 0.1\ \mu\text{F}$	T_{OFF}		0.8		μs

9. See below figure for Test Circuit and Timing Diagrams.

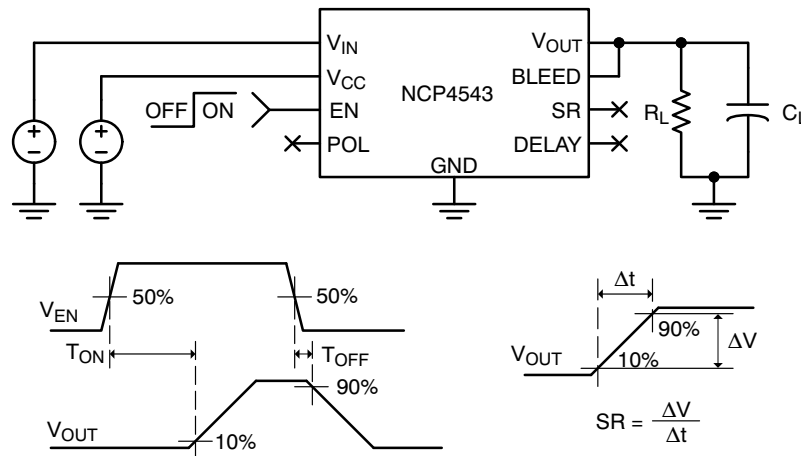

Figure 2. Test Circuit and Timing Diagrams

TYPICAL CHARACTERISTICS

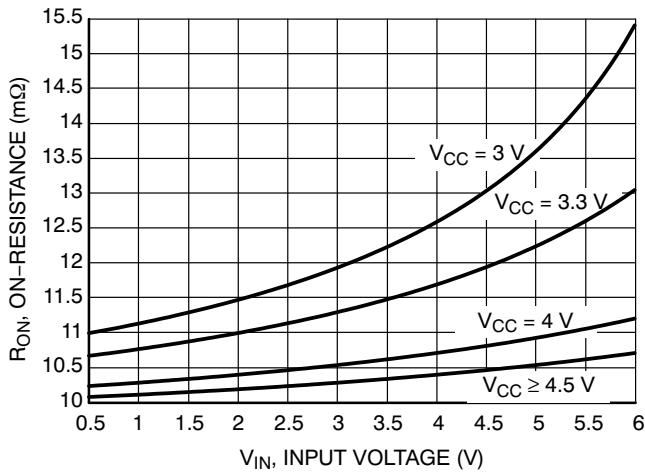

Figure 3. On-Resistance vs. Input Voltage

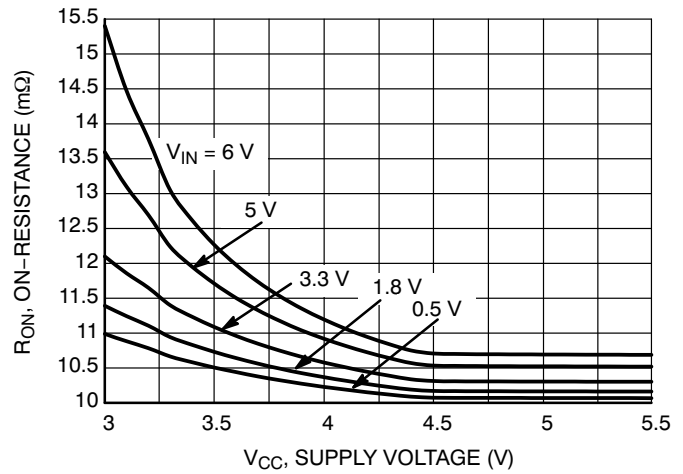

Figure 4. On-Resistance vs. Supply Voltage

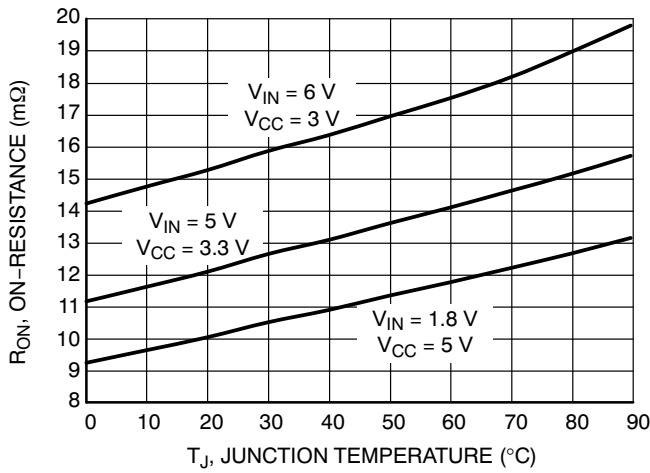

Figure 5. On-Resistance vs. Temperature

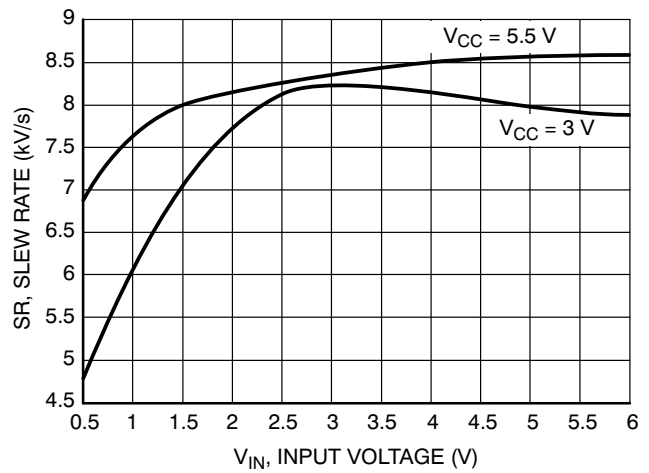

Figure 6. Slew Rate vs. Input Voltage

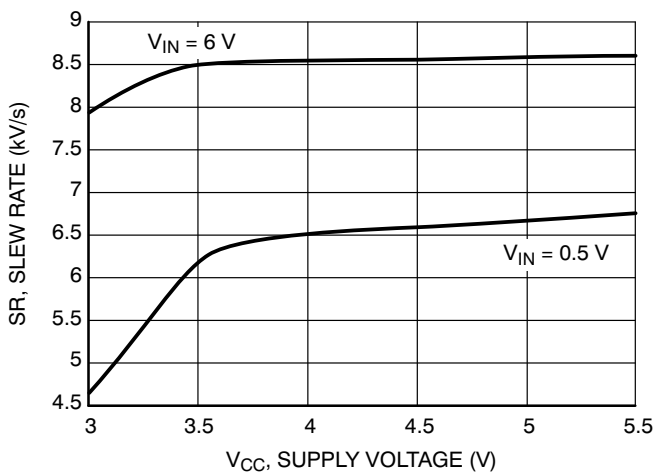

Figure 7. Slew Rate vs. Supply Voltage

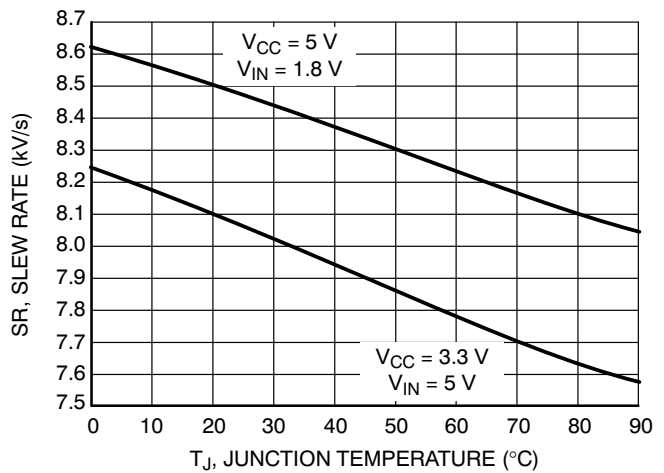

Figure 8. Slew Rate vs. Temperature

TYPICAL CHARACTERISTICS

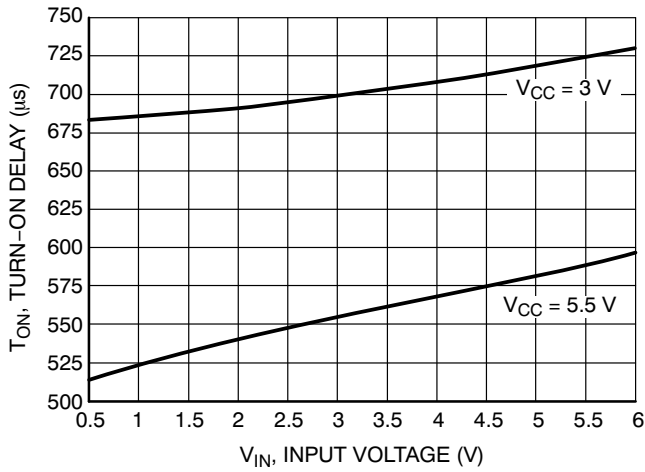

Figure 9. Turn-On Delay vs. Input Voltage

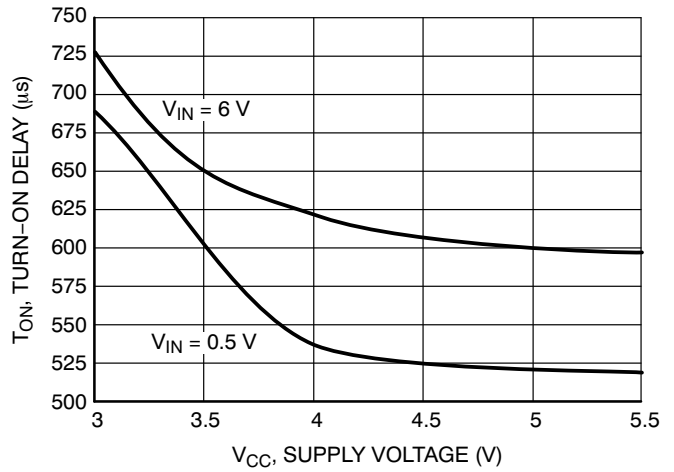

Figure 10. Turn-On Delay vs. Supply Voltage

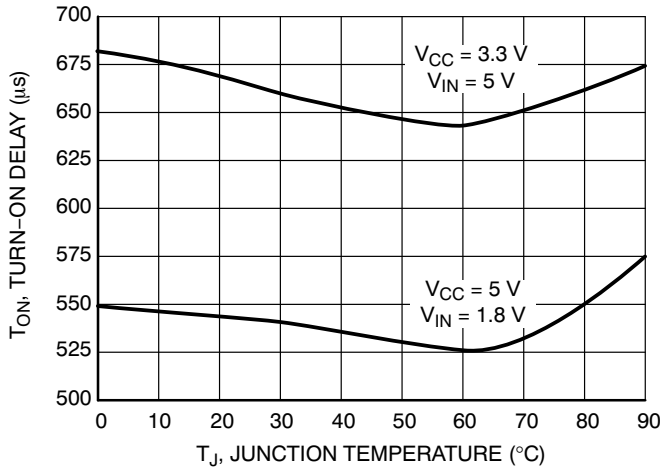

Figure 11. Turn-On Delay vs. Temperature

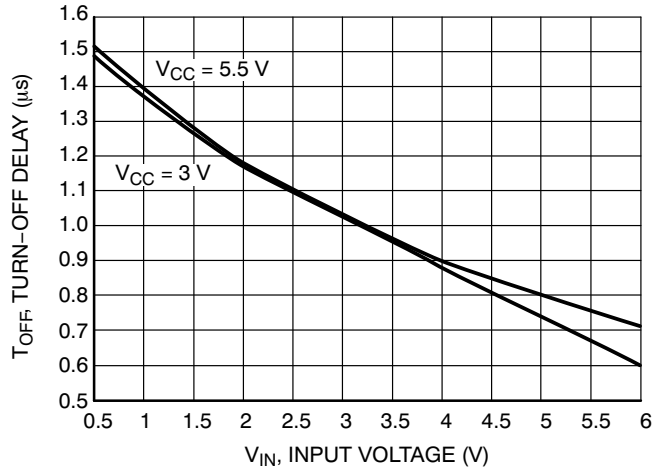

Figure 12. Turn-Off Delay vs. Input Voltage

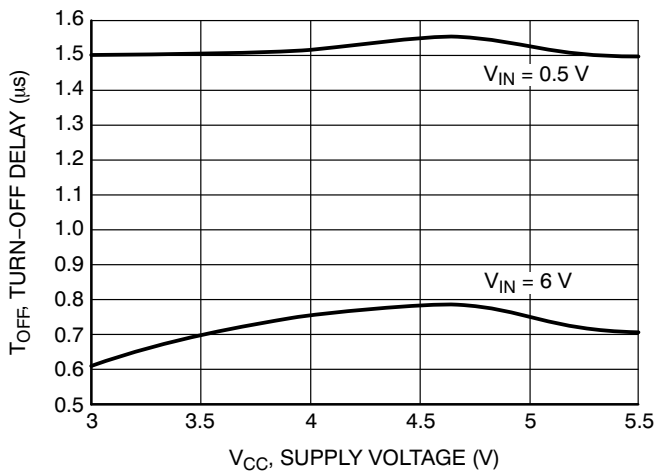

Figure 13. Turn-Off Delay vs. Supply Voltage

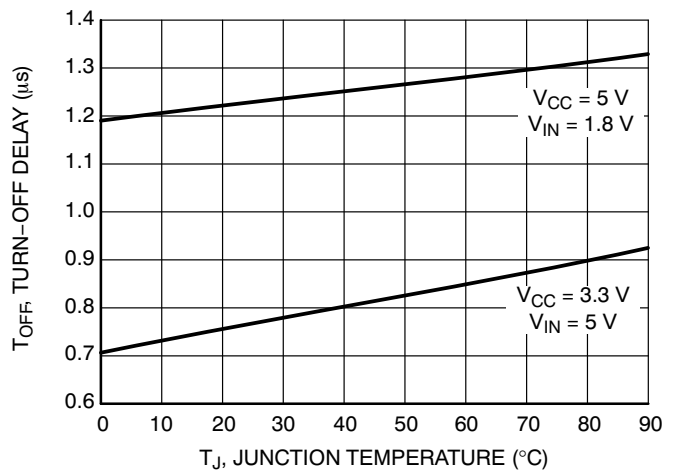

Figure 14. Turn-Off Delay vs. Temperature

NCP4543

TYPICAL CHARACTERISTICS

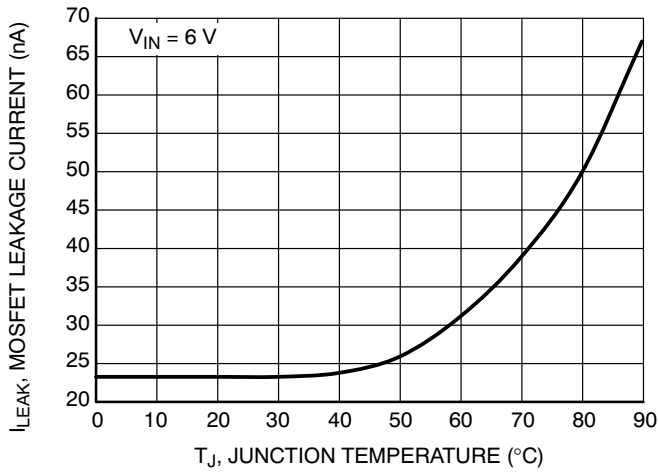

Figure 15. MOSFET Leakage Current vs. Temperature

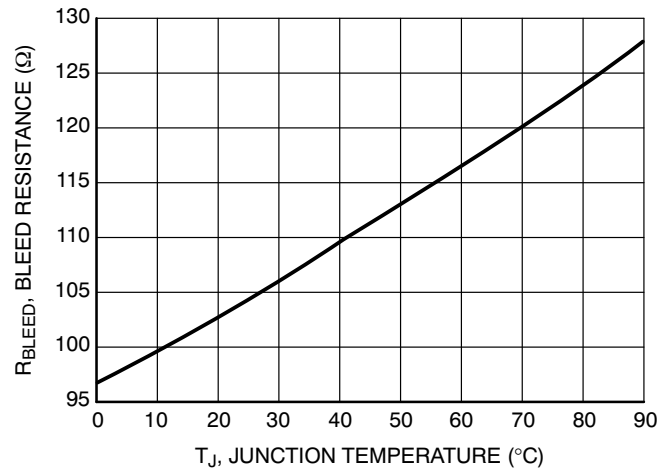

Figure 16. Bleed Resistance vs. Temperature

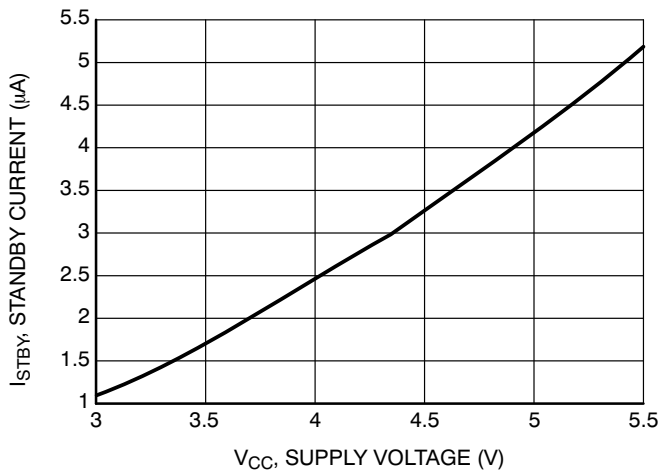

Figure 17. Standby Current vs. Supply Voltage

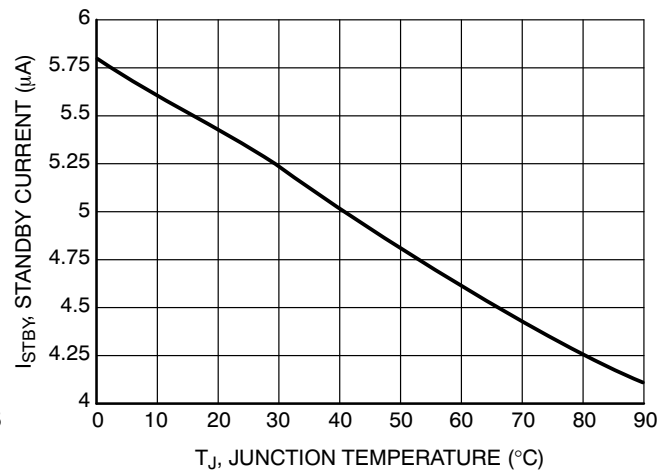

Figure 18. Standby Current vs. Temperature

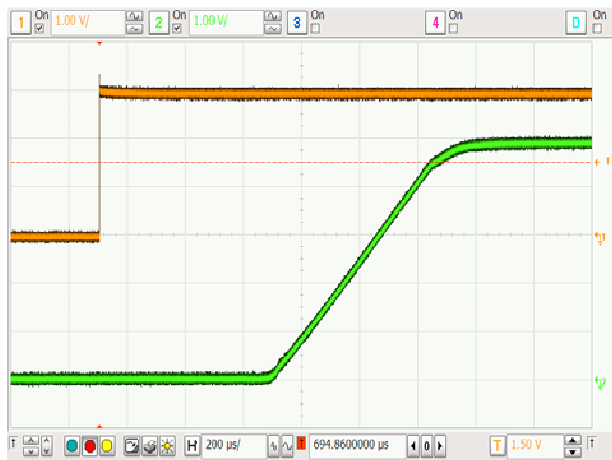

Figure 19. Turn-on Response
(V_{CC} = 3.3 V, V_{IN} = 5.0 V, R_L = 10 Ω, C_L = 0.1 μF)

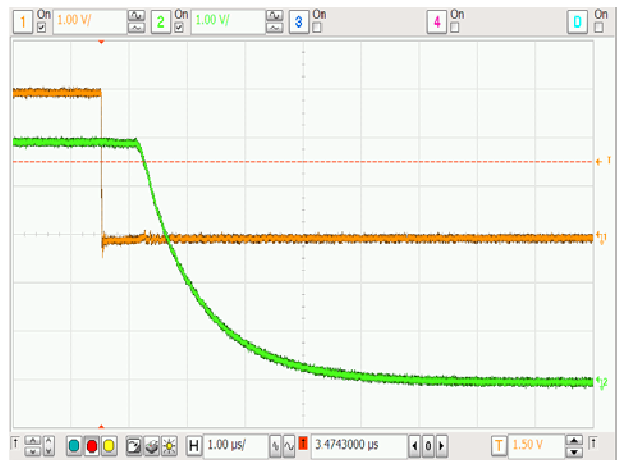

Figure 20. Turn-off Response
(V_{CC} = 3.3 V, V_{IN} = 5.0 V, R_L = 10 Ω, C_L = 0.1 μF)

APPLICATIONS INFORMATION

On-Resistance

The MOSFET gate voltage in the NCP4543 is driven by a charge pump in the controller circuit. The output voltage of the charge pump is dependent on the voltage on V_{CC}. The R_{ON} of the MOSFET is in turn dependent on its V_{GS}. Care must be taken to ensure a sufficient V_{CC} voltage is used to create the desired R_{ON} given the anticipated input voltage.

Enable Control

The NCP4543 allows for enabling the MOSFET in either an active-high or active-low configuration. When the EN and POL pins are both at a logic high level or both at a logic low level and the V_{CC} supply pin has an adequate voltage applied, the MOSFET will be enabled. Similarly, when the EN and POL pins are at different logic levels, the MOSFET will be disabled.

An internal pull down resistor on the EN pin and an internal pull up resistor on the POL pin ensure that the MOSFET will be disabled when neither pin is driven. The internal pull down or pull up resistor can also be used to allow for only one of the pins to be driven in either an active-high or active-low state.

Parametric Adjustments

The NCP4543 can be used in several configurations depending on the need to control turn-on delay, slew rate, and bleed resistance. Default minimum values of each parameter are built into the part without the requirement of external components. This configuration is shown above in Figure 1.

Figures 21 and 22 show alternate configurations where external components are used to modify the turn-on delay, slew rate, and total bleed resistance.

Figure 21 shows an external capacitor, C_{COMBO}, connected from the V_{OUT} pin to both the DELAY and SR pins. This allows for one external capacitor to be used to modify the turn-on delay and slew rate. Note that the value of C_{COMBO} is used in Equations 1 and 2 (below) in place of C_{DEL} and C_{SR} respectively.

Figure 22 shows the use of two external capacitors for independent control of the turn-on delay and slew rate.

Turn-On Delay

The NCP4543 provides a time delay between the input transitions on EN (or POL) to the MOSFET turning on. The

turn-on delay can be increased with an external capacitor added between the DELAY pin and either ground or the V_{OUT} pin as shown in Figures 21 and 22.

The total delay is calculated by adding the default turn-on delay to a delta term which is calculated as follows:

$$\Delta t = K_{DEL} * C_{DEL} \quad (\text{eq. 1})$$

where K_{DEL} is a constant and C_{DEL} is the off-chip capacitance added between the DELAY pin to either ground or the V_{OUT} pin (see table below). When no external capacitor is present, the delay will be the specified default turn-on delay.

Slew Rate Control

The NCP4543 is equipped with controlled output slew rate which provides soft start functionality. This limits the inrush current caused by capacitor charging and enables this device to be used in hot swapping applications. The slew rate can be decreased with an external capacitor added between the SR pin and the V_{OUT} pin as shown in Figures 21 and 22.

The slew rate can be calculated as follows:

$$SR = \frac{K_{SR}}{C_{SR} + C_{CHIP}} \quad (\text{eq. 2})$$

where K_{SR} is a constant, C_{SR} is the off-chip capacitance added between the SR pin and the V_{OUT} pin, and C_{CHIP} is the on-chip capacitance (see table below). Note that this equation is only valid for C_{SR} ≥ 470 pF. When no external capacitor is present, the slew rate will be the specified default slew rate.

Load Bleed

The NCP4543 has an on-chip bleed resistor that can be used to bleed the charge off of the load to ground after the MOSFET has been disabled. In series with the bleed resistor is a bleed switch which is enabled whenever the MOSFET is disabled. Delays are added to the enable of this switch to ensure that both the MOSFET and the bleed switch are not concurrently active. The total bleed resistance can be increased by adding a resistor between the BLEED pin and the V_{OUT} pin as shown in Figures 21 and 22. If the load bleed function is not desired, the BLEED pin should be tied to ground or left floating.

SLEW RATE AND TURN-ON DELAY

Parameter	Conditions	Symbol	Min	Typ	Max	Unit
Turn-on Delay Constant		K _{DEL}		1.74		MΩ
External Delay Capacitance (Note 10)	Between DEL pin and GND	C _{DEL}			10	nF
Slew Rate Constant		K _{SR}		1.4		μA
External Slew Rate Capacitance (Note 10)	Between SR pin and V _{OUT} pin	C _{SR}			2	nF
Internal Slew Rate Capacitance		C _{CHIP}		150		pF
External Combo Capacitance (Note 10)	Between SR & DEL pins and V _{OUT} pin	C _{COMBO}			2	nF

10. Recommended range, larger values may be used but may degrade the performance of the part

NCP4543

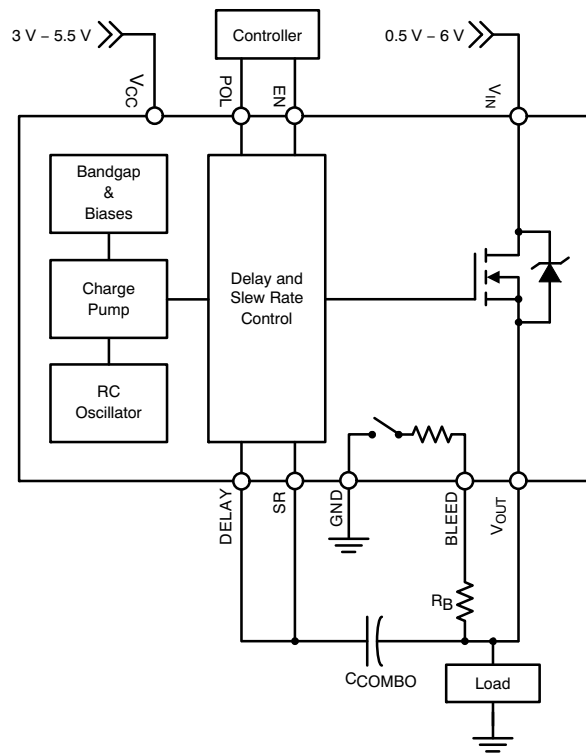

Figure 21. Example Application – External bleed resistor with single-capacitor adjustment of turn-on delay and slew rate.

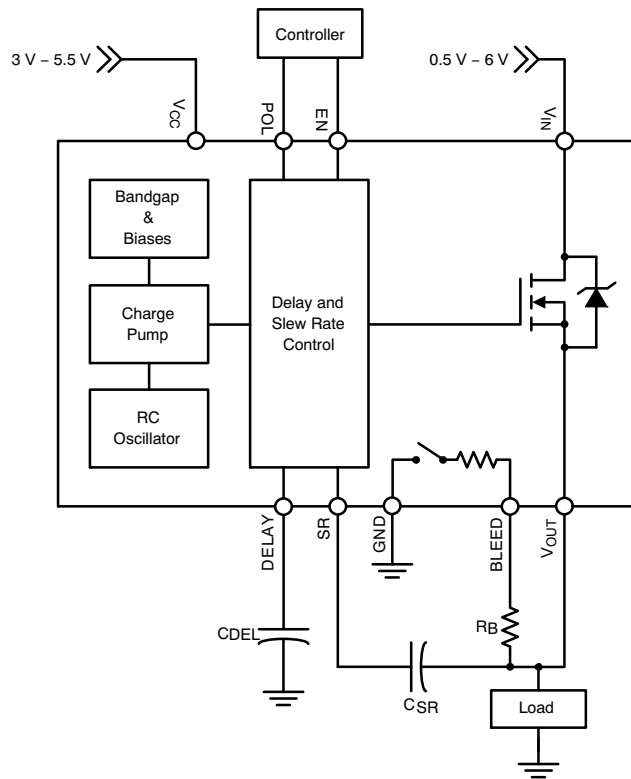
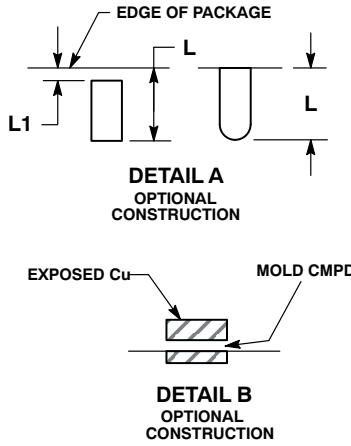
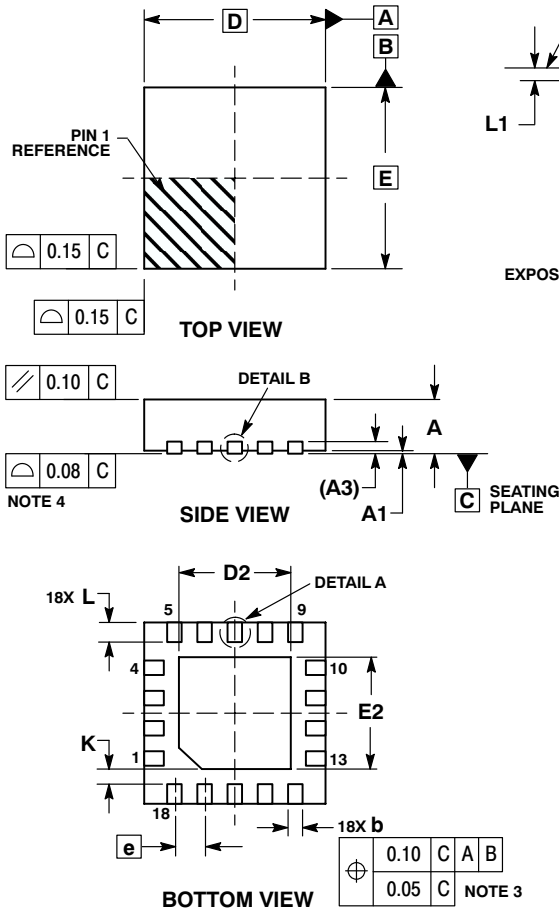

Figure 22. Example Application – External bleed resistor with independent adjustment of turn-on delay and slew rate.

NCP4543

PACKAGE DIMENSIONS

QFN18, 3x3, 0.5P
CASE 485BF
ISSUE O



NOTES:

1. DIMENSIONS AND TOLERANCING PER ASME Y14.5M, 1994.
2. CONTROLLING DIMENSION: MILLIMETERS.
3. DIMENSION b APPLIES TO PLATED TERMINAL AND IS MEASURED BETWEEN 0.15 AND 0.30 MM FROM TERMINAL.
4. COPLANARITY APPLIES TO THE EXPOSED PAD AS WELL AS THE TERMINALS.

MILLIMETERS		
DIM	MIN	MAX
A	0.80	1.00
A1	0.00	0.05
A3	0.20	REF
b	0.18	0.30
D	3.00	BSC
D2	1.75	1.95
E	3.00	BSC
E2	1.75	1.95
e	0.50	BSC
K	0.20	---
L	0.275	0.375
L1	0.00	0.15

RECOMMENDED MOUNTING FOOTPRINT

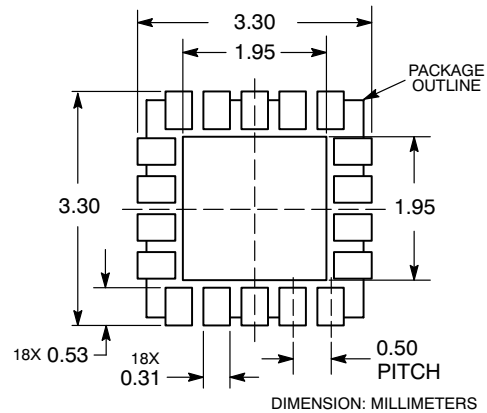

*For additional information on our Pb-Free strategy and soldering details, please download the ON Semiconductor Soldering and Mounting Techniques Reference Manual, SOLDERRM/D.

ecoSwitch is a trademark of Semiconductor Components Industries, LLC (SCILLC).

ON Semiconductor and registered trademarks of Semiconductor Components Industries, LLC (SCILLC). SCILLC reserves the right to make changes without further notice to any products herein. SCILLC makes no warranty, representation or guarantee regarding the suitability of its products for any particular purpose, nor does SCILLC assume any liability arising out of the application or use of any product or circuit, and specifically disclaims any and all liability, including without limitation special, consequential or incidental damages. "Typical" parameters which may be provided in SCILLC data sheets and/or specifications can and do vary in different applications and actual performance may vary over time. All operating parameters, including "Typicals" must be validated for each customer application by customer's technical experts. SCILLC does not convey any license under its patent rights nor the rights of others. SCILLC products are not designed, intended, or authorized for use as components in systems intended for surgical implant into the body, or other applications intended to support or sustain life, or for any other application in which the failure of the SCILLC product could create a situation where personal injury or death may occur. Should Buyer purchase or use SCILLC products for any such unintended or unauthorized application, Buyer shall indemnify and hold SCILLC and its officers, employees, subsidiaries, affiliates, and distributors harmless against all claims, costs, damages, and expenses, and reasonable attorney fees arising out of, directly or indirectly, any claim of personal injury or death associated with such unintended or unauthorized use, even if such claim alleges that SCILLC was negligent regarding the design or manufacture of the part. SCILLC is an Equal Opportunity/Affirmative Action Employer. This literature is subject to all applicable copyright laws and is not for resale in any manner.

PUBLICATION ORDERING INFORMATION

LITERATURE FULFILLMENT:
 Literature Distribution Center for ON Semiconductor
 P.O. Box 5163, Denver, Colorado 80217 USA
Phone: 303-675-2175 or 800-344-3860 Toll Free USA/Canada
Fax: 303-675-2176 or 800-344-3867 Toll Free USA/Canada
Email: orderlit@onsemi.com

N. American Technical Support: 800-282-9855 Toll Free
 USA/Canada
Europe, Middle East and Africa Technical Support:
 Phone: 421 33 790 2910
Japan Customer Focus Center
 Phone: 81-3-5817-1050

ON Semiconductor Website: www.onsemi.com
Order Literature: <http://www.onsemi.com/orderlit>
 For additional information, please contact your local Sales Representative