



MGBR40U60C

Preliminary

DIODE

DUAL MOS GATED BARRIER RECTIFIER

DESCRIPTION

The UTC MGBR40U60C is a dual mos gated barrier rectifiers, it uses UTC's advanced technology to provide customers with low forward voltage drop and high switching speed, etc.

FEATURES

- * Ultra low forward voltage drop
- * High switching speed

SYMBOL

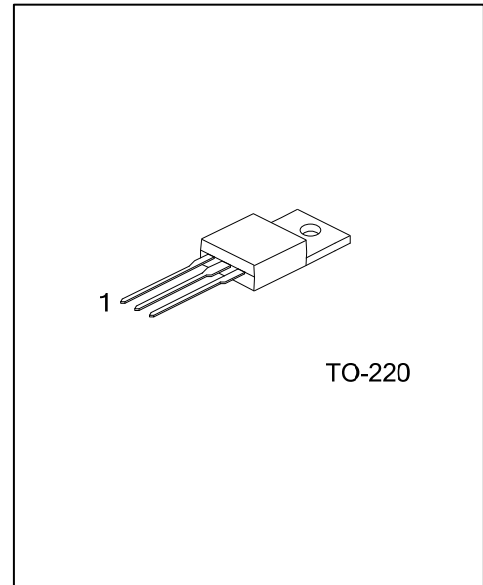
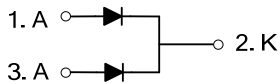

ORDERING INFORMATION

Ordering Number		Package	Pin Assignment			Packing
Lead Free	Halogen Free		1	2	3	
MGBR40U60CL-TA3-T	MGBR40U60CG-TA3-T	TO-220	A	K	A	Tube

Note: Pin Assignment: A: Anode, K: Cathode

MGBR40U60CL-TA3-T	(1)Packing Type	(1) T: Tube
	(2)Package Type	(2) TA3: TO-220
	(3)Lead Free	(3) L: Lead Free, G: Halogen Free

■ ABSOLUTE MAXIMUM RATINGS (PER LEG) ($T_A=25^\circ\text{C}$ unless otherwise specified)

Single phase, half wave, 60Hz, resistive or inductive load.

For capacitance load, derate current by 20%.

PARAMETER	SYMBOL	RATINGS	UNIT
DC Blocking Voltage	V_{RM}	60	V
Working Peak Reverse Voltage	V_{RWM}	60	V
Peak Repetitive Reverse Voltage	V_{RRM}	60	V
Average Rectified Output Current Per Device	Per Leg	20	A
	Total	40	A
Non-Repetitive Peak Forward Surge Current 8.3ms Single Half Sine-Wave Superimposed on Rated Load	I_{FSM}	400	A
Operating Junction Temperature	T_J	-65~+150	$^\circ\text{C}$
Storage Temperature	T_{STG}	-65~+150	$^\circ\text{C}$

Note: Absolute maximum ratings are those values beyond which the device could be permanently damaged. Absolute maximum ratings are stress ratings only and functional device operation is not implied.

■ THERMAL CHARACTERISTICS (PER LEG)

PARAMETER	SYMBOL	RATINGS	UNIT
Junction to Ambient	θ_{JA}	62.5	$^\circ\text{C/W}$
Junction to Case	θ_{JC}	2	$^\circ\text{C/W}$

■ ELECTRICAL CHARACTERISTICS (PER LEG) ($T_A=25^\circ\text{C}$ unless otherwise specified.)

PARAMETER	SYMBOL	TEST CONDITIONS	MIN	TYP	MAX	UNIT
Reverse Breakdown Voltage (Note 1)	$V_{(BR)R}$	$I_R=0.50\text{mA}$	60			V
Forward Voltage Drop	V_{FM}	$I_F=20\text{A}, T_J=25^\circ\text{C}$			0.50	V
		$I_F=20\text{A}, T_J=125^\circ\text{C}$			0.45	V
Leakage Current (Note 1)	I_{RM}	$V_R=60\text{V}, T_J=25^\circ\text{C}$			500	μA
		$V_R=60\text{V}, T_J=125^\circ\text{C}$			100	mA

Notes: 1. Short duration pulse test used to minimize self-heating effect.
2. Thermal resistance junction to case mounted on heatsink.

UTC assumes no responsibility for equipment failures that result from using products at values that exceed, even momentarily, rated values (such as maximum ratings, operating condition ranges, or other parameters) listed in products specifications of any and all UTC products described or contained herein. UTC products are not designed for use in life support appliances, devices or systems where malfunction of these products can be reasonably expected to result in personal injury. Reproduction in whole or in part is prohibited without the prior written consent of the copyright owner. The information presented in this document does not form part of any quotation or contract, is believed to be accurate and reliable and may be changed without notice.