

4.5 A, 600 V very fast IGBT with Ultrafast diode

Features

- Minimal tail current
- Low conduction and switching losses
- Ultrafast soft recovery antiparallel diode

Applications

Motor drive

Description

The STGD3HF60HD is based on a new advanced planar technology concept to yield an IGBT with more stable switching performance (E_{off}) versus temperature, as well as lower conduction losses.

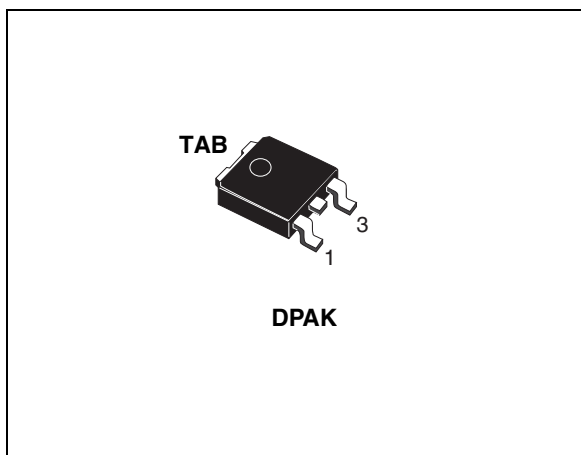

Figure 1. Internal schematic diagram

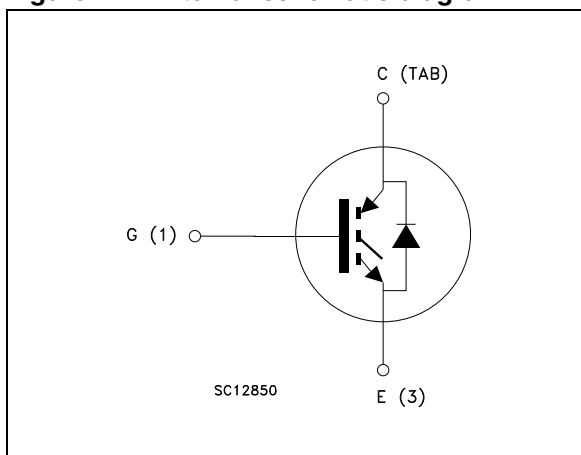

Table 1. Device summary

Order codes	Marking	Package	Packaging
STGD3HF60HDT4	GD3HF60HD	DPAK	Tape and reel

Contents

1	Electrical ratings	3
2	Electrical characteristics	4
2.1	Electrical characteristics (curves)	6
3	Test circuits	8
4	Package mechanical data	9
5	Packaging mechanical data	11
6	Revision history	13

1 Electrical ratings

Table 2. Absolute maximum ratings

Symbol	Parameter	Value	Unit
V_{CES}	Collector-emitter voltage ($V_{GE} = 0$)	600	V
$I_C^{(1)}$	Continuous collector current at $T_C = 25\text{ °C}$	7.5	A
$I_C^{(1)}$	Continuous collector current at $T_C = 100\text{ °C}$	4.5	A
$I_{CL}^{(2)}$	Turn-off latching current	18	A
$I_{CP}^{(3)}$	Pulsed collector current	18	A
V_{GE}	Gate-emitter voltage	± 20	V
I_F	Diode RMS forward current at $T_C = 25\text{ °C}$	10	A
I_{FSM}	Surge non repetitive forward current $t_p=10\text{ms}$ sinusoidal	25	A
P_{TOT}	Total dissipation at $T_C = 25\text{ °C}$	38	W
T_j	Operating junction temperature	- 55 to 150	$^{\circ}\text{C}$

1. Calculated according to the iterative formula:

$$I_C(T_C) = \frac{T_{j(\max)} - T_C}{R_{thj-c} \times V_{CE(\text{sat})(\max)}(T_{j(\max)}, I_C(T_C))}$$

2. $V_{\text{clamp}} = 80\% \cdot (V_{CES})$, $T_j = 150\text{ °C}$, $R_G = 10\ \Omega$, $V_{GE} = 15\text{ V}$.

3. Pulse width limited by maximum junction temperature and turn-off within RBSOA.

Table 3. Thermal data

Symbol	Parameter	Value	Unit
$R_{thj\text{-case}}$	Thermal resistance junction-case IGBT	3.3	$^{\circ}\text{C/W}$
	Thermal resistance junction-case diode	5	$^{\circ}\text{C/W}$
$R_{thj\text{-amb}}$	Thermal resistance junction-ambient	100	$^{\circ}\text{C/W}$

2 Electrical characteristics

($T_j=25\text{ °C}$ unless otherwise specified).

Table 4. Static electrical characteristics

Symbol	Parameter	Test conditions	Min.	Typ.	Max.	Unit
$V_{(BR)CES}$	Collector-emitter breakdown voltage ($V_{GE} = 0$)	$I_C = 1\text{ mA}$	600			V
$V_{CE(sat)}$	Collector-emitter saturation voltage	$V_{GE} = 15\text{ V}$, $I_C = 0.5\text{ A}$, $T_j = 125\text{ °C}$ $V_{GE} = 15\text{ V}$, $I_C = 1.5\text{ A}$ $V_{GE} = 15\text{ V}$, $I_C = 1.5\text{ A}$, $T_j = 125\text{ °C}$		1.4 2.45 1.85	2.95	V
$V_{GE(th)}$	Gate threshold voltage	$V_{CE} = V_{GE}$, $I_C = 250\text{ }\mu\text{A}$	3.75		5.75	V
I_{CES}	Collector cut-off current ($V_{GE} = 0$)	$V_{CE} = 600\text{ V}$ $V_{CE} = 600\text{ V}$, $T_j = 125\text{ °C}$			250 1	μA mA
I_{GES}	Gate-emitter leakage current ($V_{CE} = 0$)	$V_{GE} = \pm 20\text{ V}$			± 100	nA
g_{fs}	Forward transconductance	$V_{CE} = 15\text{ V}$, $I_C = 1.5\text{ A}$		1.5		S

Table 5. Dynamic electrical characteristics

Symbol	Parameter	Test conditions	Min.	Typ.	Max.	Unit
C_{ies}	Input capacitance	$V_{CE} = 25\text{ V}$, $f = 1\text{ MHz}$, $V_{GE} = 0$	-	152	-	pF
C_{oes}	Output capacitance			14		pF
C_{res}	Reverse transfer capacitance			3		pF
Q_g	Total gate charge	$V_{CE} = 480\text{ V}$, $I_C = 1.5\text{ A}$, $V_{GE} = 15\text{ V}$ (see Figure 18)	-	12	-	nC
Q_{ge}	Gate-emitter charge			2		nC
Q_{gc}	Gate-collector charge			6		nC

Table 6. Switching on/off (inductive load)

Symbol	Parameter	Test conditions	Min.	Typ.	Max.	Unit
$t_{d(on)}$	Turn-on delay time	$V_{CC} = 400\text{ V}, I_C = 1.5\text{ A}$		11		ns
t_r	Current rise time	$R_G = 100\ \Omega, V_{GE} = 15\text{ V}$	-	4	-	ns
$(di/dt)_{on}$	Turn-on current slope	(see Figure 19)		285		A/ μ s
$t_{d(on)}$	Turn-on delay time	$V_{CC} = 400\text{ V}, I_C = 1.5\text{ A}$		10		ns
t_r	Current rise time	$R_G = 100\ \Omega, V_{GE} = 15\text{ V},$	-	5	-	ns
$(di/dt)_{on}$	Turn-on current slope	$T_j = 125\text{ }^\circ\text{C}$ (see Figure 19)		265		A/ μ s
$t_r(V_{off})$	Off voltage rise time	$V_{CC} = 400\text{ V}, I_C = 1.5\text{ A},$		26		ns
$t_{d(off)}$	Turn-off delay time	$R_{GE} = 100\ \Omega, V_{GE} = 15\text{ V}$	-	60	-	ns
t_f	Current fall time	(see Figure 19)		50		ns
$t_r(V_{off})$	Off voltage rise time	$V_{CC} = 400\text{ V}, I_C = 1.5\text{ A},$		64		ns
$t_{d(off)}$	Turn-off delay time	$R_{GE} = 100\ \Omega, V_{GE} = 15\text{ V},$	-	69	-	ns
t_f	Current fall time	$T_j = 125\text{ }^\circ\text{C}$ (see Figure 19)		71		ns

Table 7. Switching energy (inductive load)

Symbol	Parameter	Test conditions	Min.	Typ.	Max.	Unit
$E_{on}^{(1)}$	Turn-on switching losses	$V_{CC} = 400\text{ V}, I_C = 1.5\text{ A}$		19		μ J
$E_{off}^{(2)}$	Turn-off switching losses	$R_G = 100\ \Omega, V_{GE} = 15\text{ V}$	-	12	-	μ J
E_{ts}	Total switching losses	(see Figure 19)		31		μ J
$E_{on}^{(1)}$	Turn-on switching losses	$V_{CC} = 400\text{ V}, I_C = 1.5\text{ A}$		38		μ J
$E_{off}^{(2)}$	Turn-off switching losses	$R_G = 100\ \Omega, V_{GE} = 15\text{ V},$	-	35	-	μ J
E_{ts}	Total switching losses	$T_j = 125\text{ }^\circ\text{C}$ (see Figure 19)		73		μ J

1. E_{on} is the turn-on losses when a typical diode is used in the test circuit in (see Figure 20). If the IGBT is offered in a package with a co-pak diode, the co-pak diode is used as external diode. IGBTs and diode are at the same temperature (25°C and 125°C).
2. Turn-off losses include also the tail of the collector current.

Table 8. Collector-emitter diode

Symbol	Parameter	Test conditions	Min.	Typ.	Max.	Unit
V_F	Forward on-voltage	$I_F = 1.5\text{ A}$ $I_F = 1.5\text{ A}, T_j = 125\text{ }^\circ\text{C}$	-	1.4 1.15	1.8	V
t_{rr}	Reverse recovery time	$I_F = 1.5\text{ A}, V_R = 40\text{ V},$		85		ns
Q_{rr}	Reverse recovery charge	$di/dt = 100\text{ A}/\mu\text{s}$	-	124		nC
I_{rrm}	Reverse recovery current	(see Figure 20)		3		A
t_{rr}	Reverse recovery time	$I_F = 1.5\text{ A}, V_R = 40\text{ V},$		114		ns
Q_{rr}	Reverse recovery charge	$T_j = 125\text{ }^\circ\text{C}, di/dt = 100\text{ A}/\mu\text{s}$	-	194		nC
I_{rrm}	Reverse recovery current	(see Figure 20)		3.5		A

2.1 Electrical characteristics (curves)

Figure 2. Output characteristics

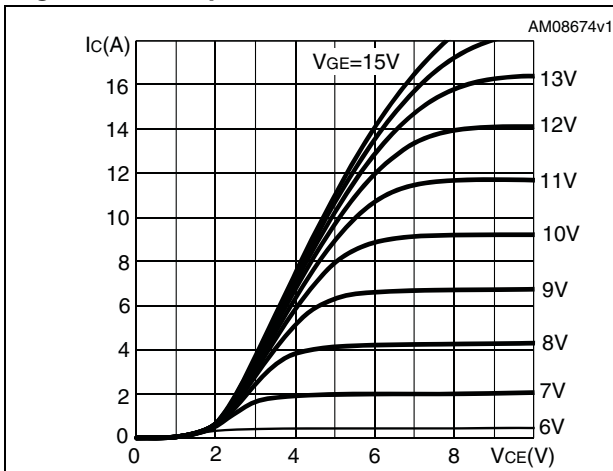

Figure 3. Output characteristic details

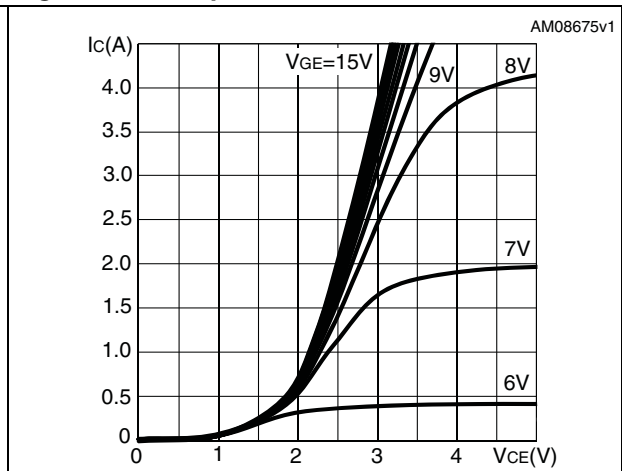

Figure 4. Transfer characteristics

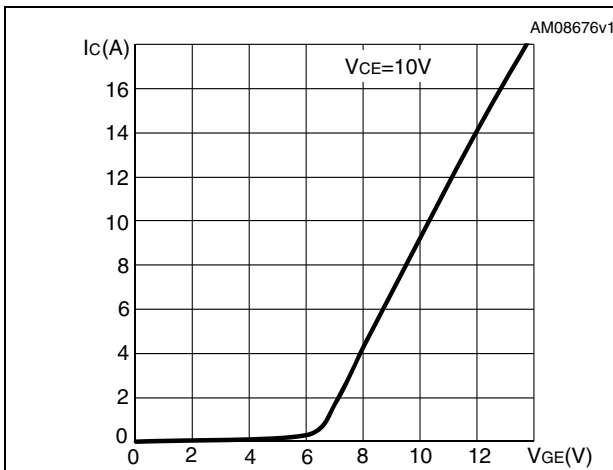

Figure 5. Collector-emitter on voltage vs collector current

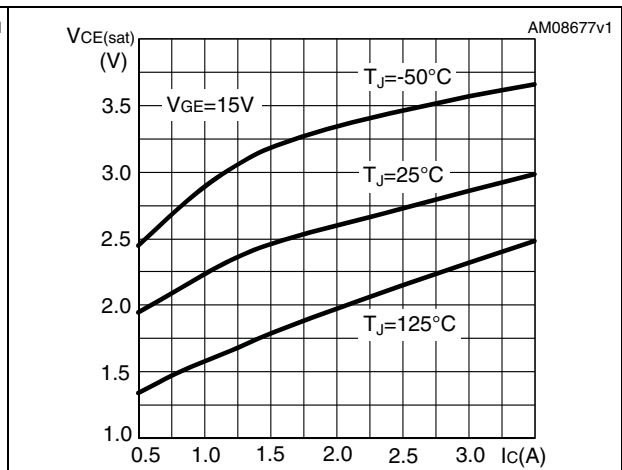

Figure 6. Collector-emitter on voltage vs temperature

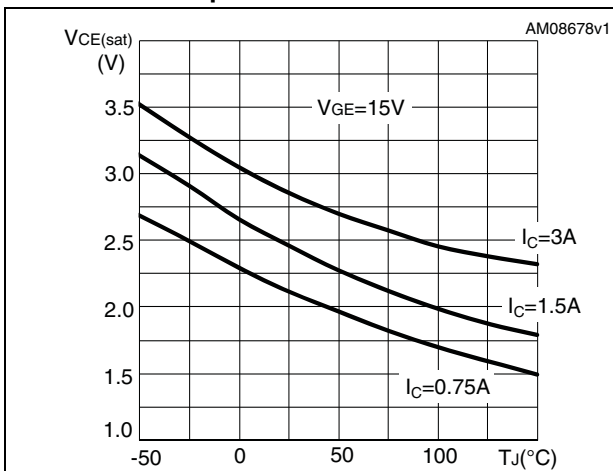

Figure 7. Breakdown voltage vs temperature

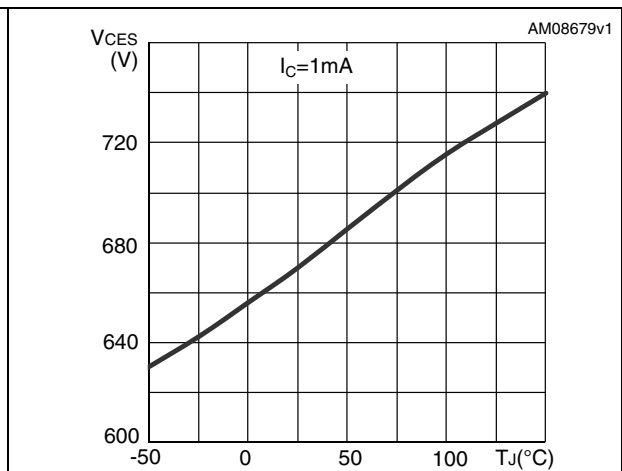

Figure 8. Gate threshold voltage vs temperature

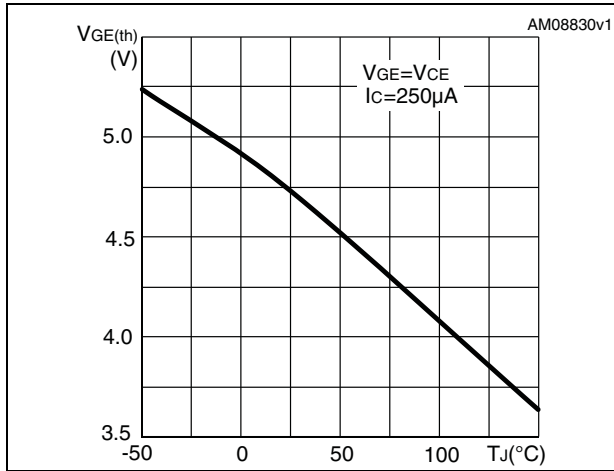

Figure 9. Gate charge vs gate-emitter voltage

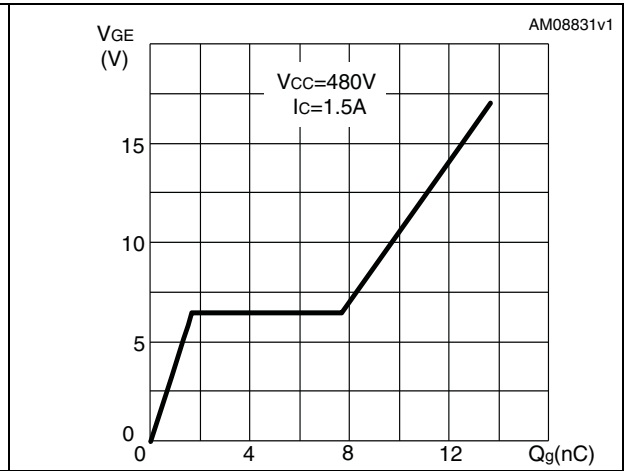

Figure 10. Capacitance variations

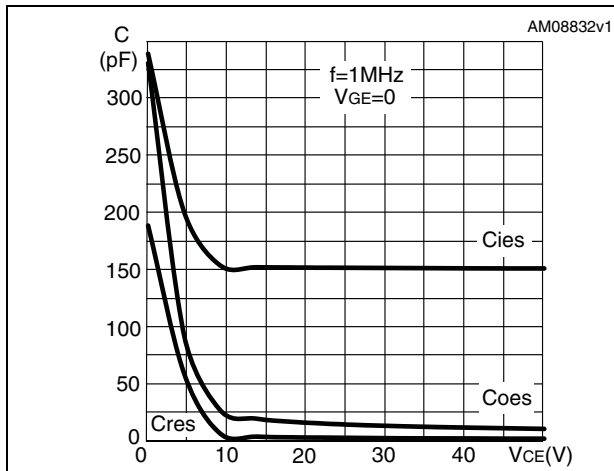

Figure 11. Switching losses vs collector current

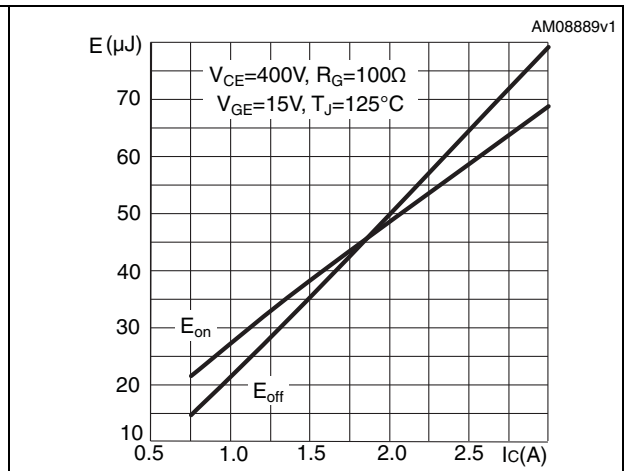

Figure 12. Switching losses vs gate resistance Figure 13. Switching losses vs temperature

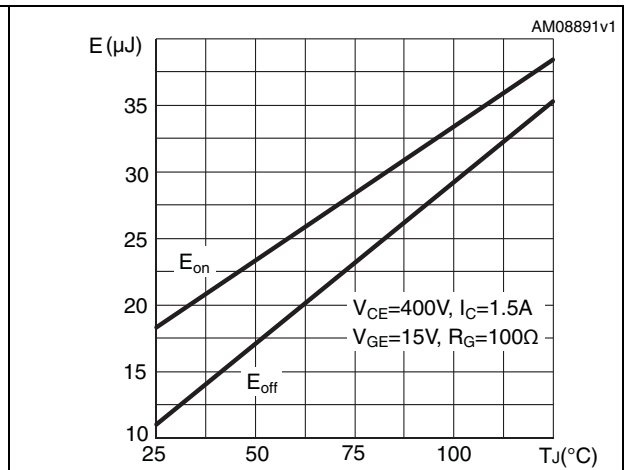
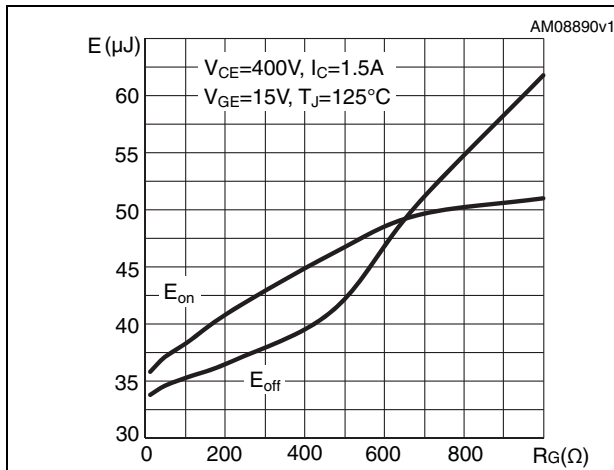

Figure 14. Turn-off SOA

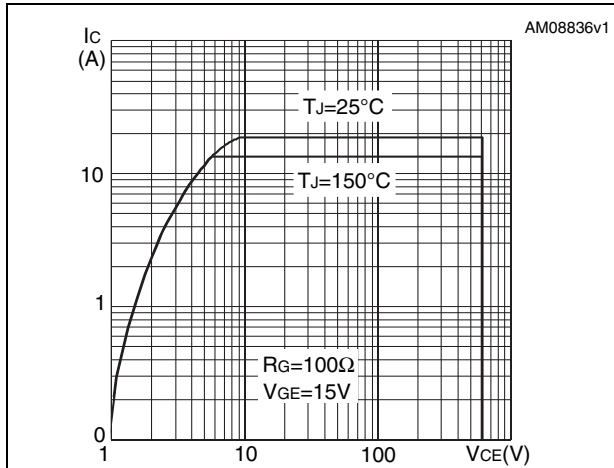

Figure 15. Diode forward on voltage

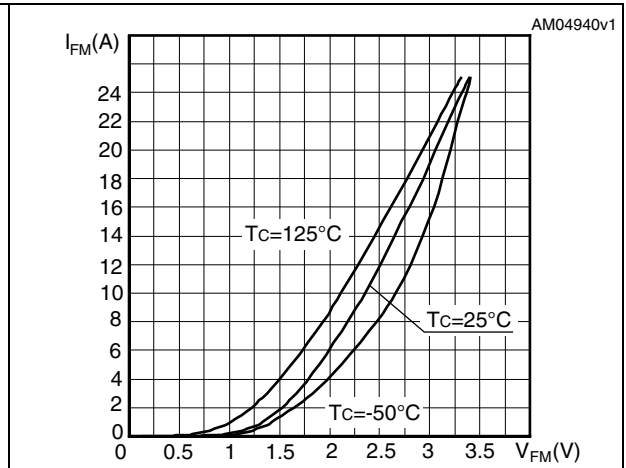
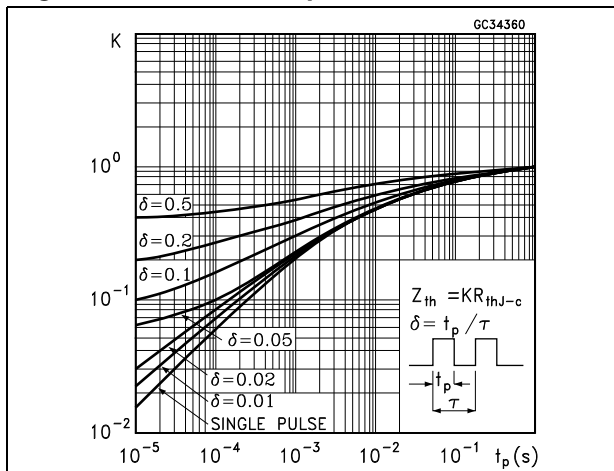

Figure 16. Thermal impedance



3 Test circuits

Figure 17. Test circuit for inductive load switching

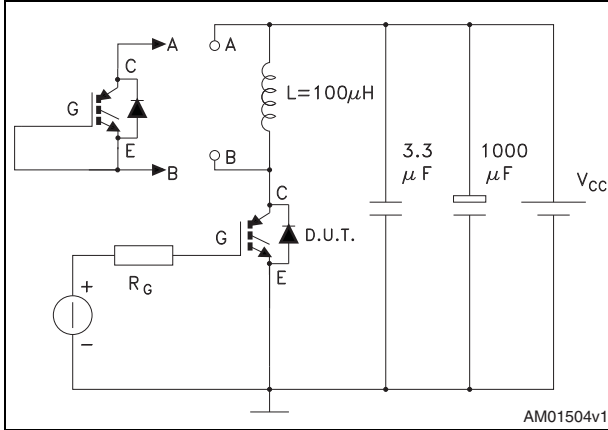

Figure 18. Gate charge test circuit

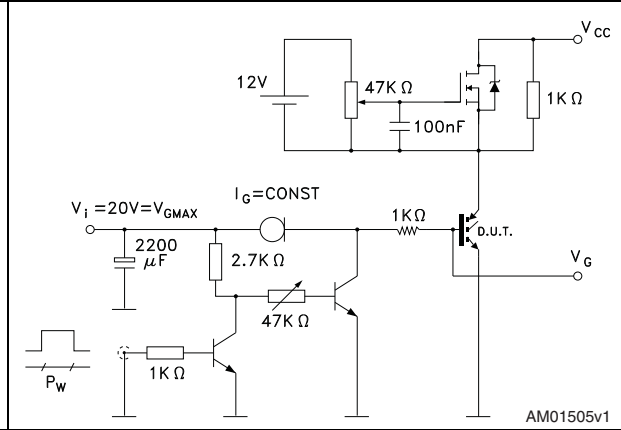

Figure 19. Switching waveform

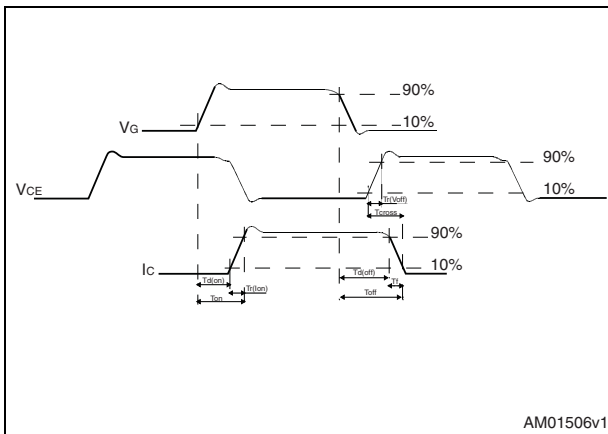
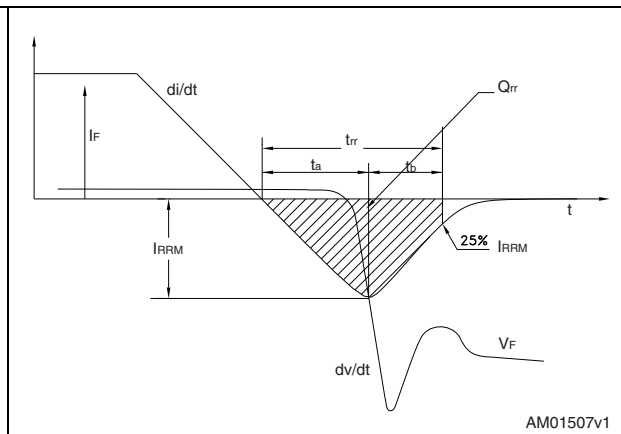

Figure 20. Diode recovery time waveform



4 Package mechanical data

In order to meet environmental requirements, ST offers these devices in different grades of ECOPACK[®] packages, depending on their level of environmental compliance. ECOPACK[®] specifications, grade definitions and product status are available at: www.st.com. ECOPACK[®] is an ST trademark.

Table 9. DPAK (TO-252) mechanical data

Dim.	mm		
	Min.	Typ.	Max.
A	2.20		2.40
A1	0.90		1.10
A2	0.03		0.23
b	0.64		0.90
b4	5.20		5.40
c	0.45		0.60
c2	0.48		0.60
D	6.00		6.20
D1		5.10	
E	6.40		6.60
E1		4.70	
e		2.28	
e1	4.40		4.60
H	9.35		10.10
L	1		
L1		2.80	
L2		0.80	
L4	0.60		1
R		0.20	
V2	0°		8°

Figure 21. DPAK (TO-252) drawing

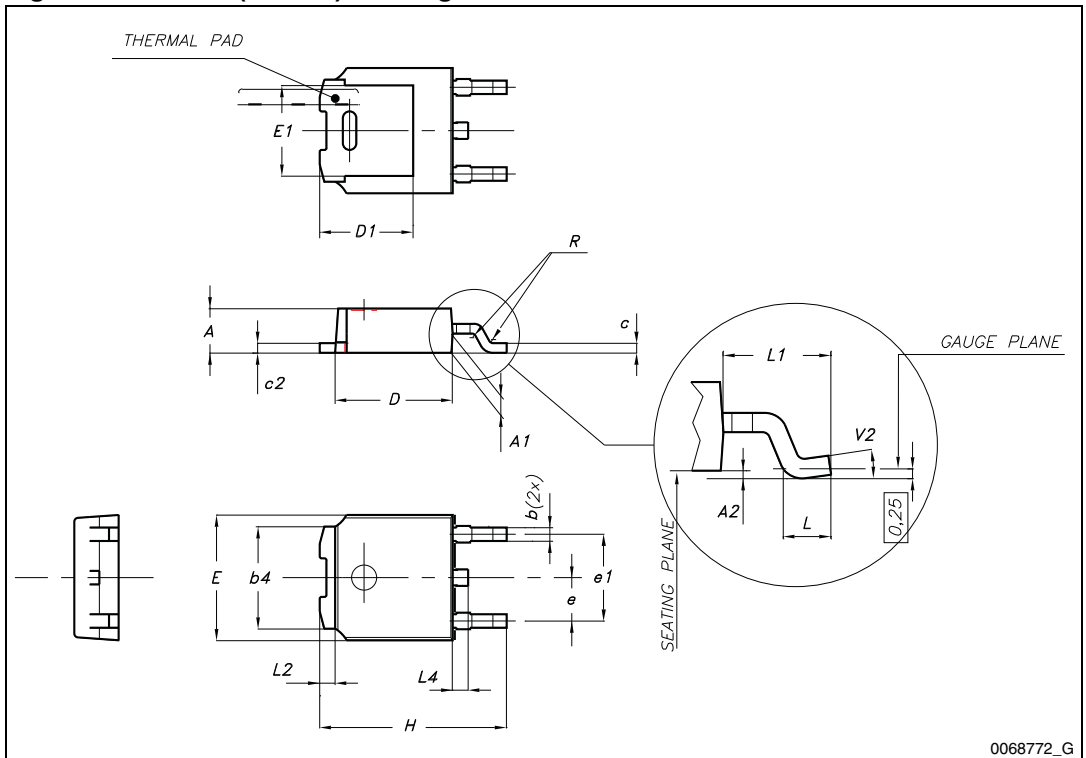

5 Packaging mechanical data

Table 10. DPAK (TO-252) tape and reel mechanical data

Tape			Reel		
Dim.	mm		Dim.	mm	
	Min.	Max.		Min.	Max.
A0	6.8	7	A		330
B0	10.4	10.6	B	1.5	
B1		12.1	C	12.8	13.2
D	1.5	1.6	D	20.2	
D1	1.5		G	16.4	18.4
E	1.65	1.85	N	50	
F	7.4	7.6	T		22.4
K0	2.55	2.75			
P0	3.9	4.1	Base qty.	2500	
P1	7.9	8.1	Bulk qty.	2500	
P2	1.9	2.1			
R	40				
T	0.25	0.35			
W	15.7	16.3			

Figure 22. DPAK footprint^(a)

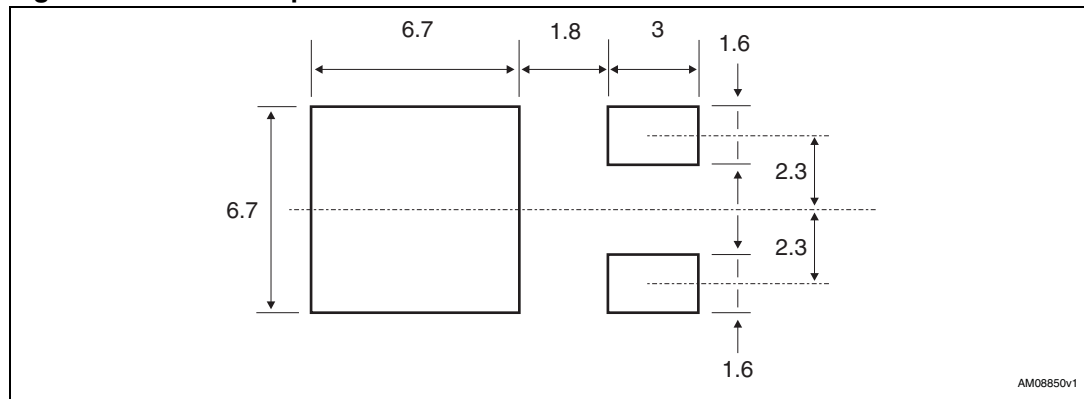

a. All dimension are in millimeters

Figure 23. Tape for DPAK (TO-252)

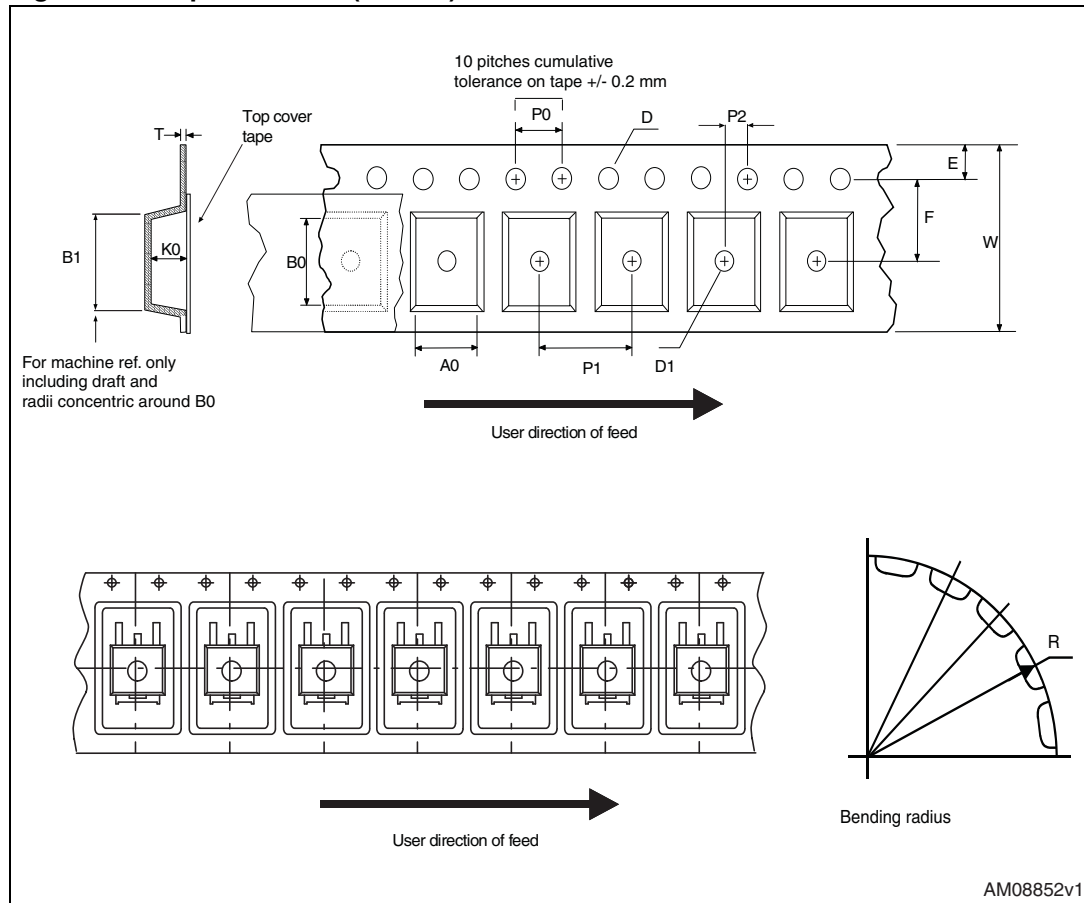
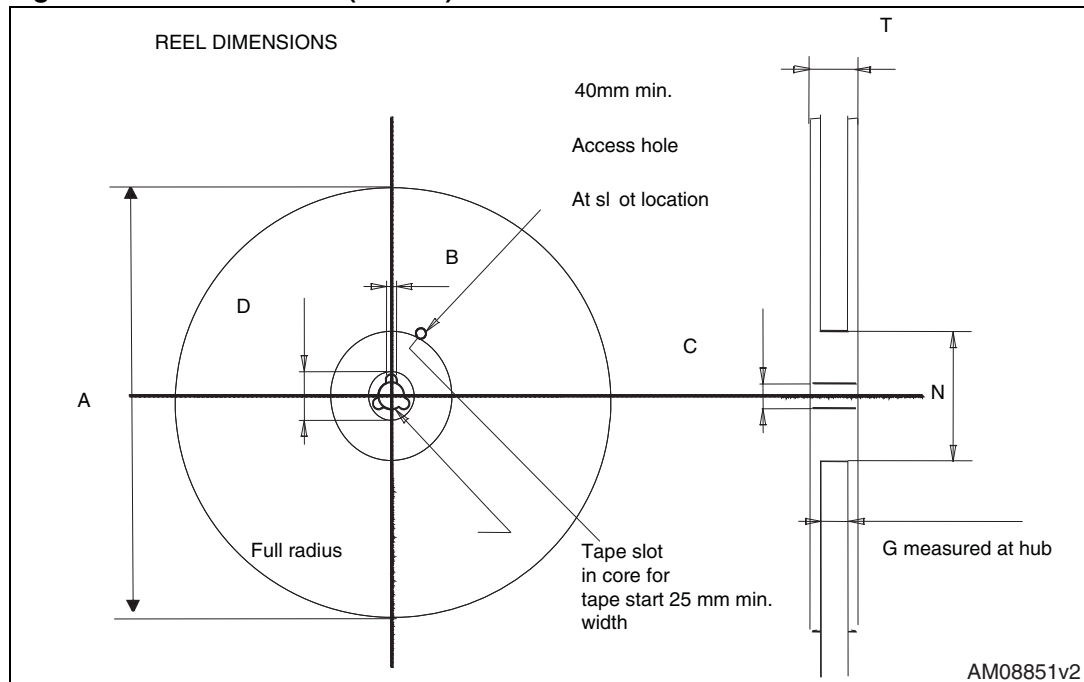

Figure 24. Reel for DPAK (TO-252)



6 Revision history

Table 11. Document revision history

Date	Revision	Changes
29-Jun-2010	1	First release.
09-Sep-2010	2	Some values changed in Table 2 .
22-Dec-2010	3	Document status promoted from preliminary data to datasheet.

Please Read Carefully:

Information in this document is provided solely in connection with ST products. STMicroelectronics NV and its subsidiaries ("ST") reserve the right to make changes, corrections, modifications or improvements, to this document, and the products and services described herein at any time, without notice.

All ST products are sold pursuant to ST's terms and conditions of sale.

Purchasers are solely responsible for the choice, selection and use of the ST products and services described herein, and ST assumes no liability whatsoever relating to the choice, selection or use of the ST products and services described herein.

No license, express or implied, by estoppel or otherwise, to any intellectual property rights is granted under this document. If any part of this document refers to any third party products or services it shall not be deemed a license grant by ST for the use of such third party products or services, or any intellectual property contained therein or considered as a warranty covering the use in any manner whatsoever of such third party products or services or any intellectual property contained therein.

UNLESS OTHERWISE SET FORTH IN ST'S TERMS AND CONDITIONS OF SALE ST DISCLAIMS ANY EXPRESS OR IMPLIED WARRANTY WITH RESPECT TO THE USE AND/OR SALE OF ST PRODUCTS INCLUDING WITHOUT LIMITATION IMPLIED WARRANTIES OF MERCHANTABILITY, FITNESS FOR A PARTICULAR PURPOSE (AND THEIR EQUIVALENTS UNDER THE LAWS OF ANY JURISDICTION), OR INFRINGEMENT OF ANY PATENT, COPYRIGHT OR OTHER INTELLECTUAL PROPERTY RIGHT.

UNLESS EXPRESSLY APPROVED IN WRITING BY AN AUTHORIZED ST REPRESENTATIVE, ST PRODUCTS ARE NOT RECOMMENDED, AUTHORIZED OR WARRANTED FOR USE IN MILITARY, AIR CRAFT, SPACE, LIFE SAVING, OR LIFE SUSTAINING APPLICATIONS, NOR IN PRODUCTS OR SYSTEMS WHERE FAILURE OR MALFUNCTION MAY RESULT IN PERSONAL INJURY, DEATH, OR SEVERE PROPERTY OR ENVIRONMENTAL DAMAGE. ST PRODUCTS WHICH ARE NOT SPECIFIED AS "AUTOMOTIVE GRADE" MAY ONLY BE USED IN AUTOMOTIVE APPLICATIONS AT USER'S OWN RISK.

Resale of ST products with provisions different from the statements and/or technical features set forth in this document shall immediately void any warranty granted by ST for the ST product or service described herein and shall not create or extend in any manner whatsoever, any liability of ST.

ST and the ST logo are trademarks or registered trademarks of ST in various countries.

Information in this document supersedes and replaces all information previously supplied.

The ST logo is a registered trademark of STMicroelectronics. All other names are the property of their respective owners.

© 2010 STMicroelectronics - All rights reserved

STMicroelectronics group of companies

Australia - Belgium - Brazil - Canada - China - Czech Republic - Finland - France - Germany - Hong Kong - India - Israel - Italy - Japan - Malaysia - Malta - Morocco - Philippines - Singapore - Spain - Sweden - Switzerland - United Kingdom - United States of America

www.st.com