

Features

- Dual power supply
- Thick film hybrid
- Minimum output power - 24 W
- Tone controlling
- Constant current drive

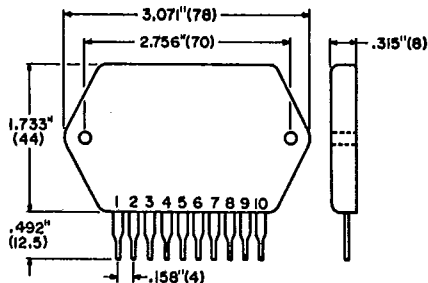

Absolute Maximum Ratings

Characteristic	Symbol	Rating	Unit
Supply Voltage	V_{CC}	± 35	V
Operating Case Temperature	T_C	85	$^{\circ}C$
Storage Temperature	T_{stg}	-30 to +100	$^{\circ}C$
Allowable Load Shorting Time	t_s $V_{CC} = \pm 29 V$ $f = 50 Hz$ $V_O = 14.2 V$	2	sec

Equivalent Circuit

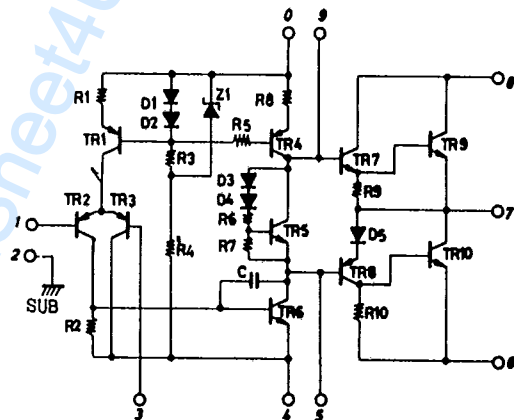

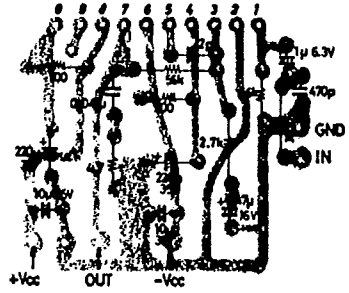
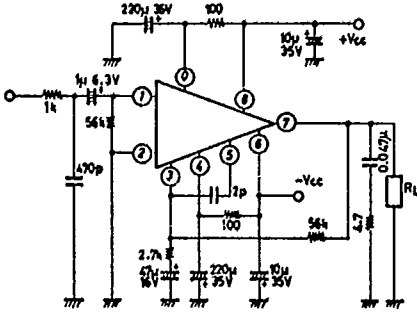

Operational Characteristics ($T_A = 25^\circ\text{C}$, $V_{CC} = \pm 25\text{ V}$, $R_L = 8\ \Omega$, $R_g = 600\ \Omega$, $V_G = 26.4\ \text{dB}$)

Characteristic	Symbol	Test Condition	Min	Typ	Max	Unit
Quiescent Current	I_{CCO}	$V_{CC} = \pm 29\text{ V}$		50	100	mA
Output Power	$P_{O(1)}$	THD = 0.2%, $f = 20\text{ to }20\text{ kHz}$	24			W
	$P_{O(2)}$	THD = 0.2%, $f = 1\text{ kHz}$		28		
	$P_{O(3)}$	THD = 0.2%, $V_{CC} = \pm 29\text{ V}$, $f = 1\text{ kHz}$		40		
Distortion	THD(1)	$P_O = 0.1\text{ to }24\text{ W}$, $f = 20\text{ to }20\text{ kHz}$			0.2	%
	THD(2)	$P_O = 1\text{ W}$, $f = 1\text{ kHz}$		0.03		
Frequency Response	f	$P_O = 1\text{ W}$, $\pm 1\text{ dB}$		10 to 100 K		Hz
Input Resistance	η	$P_O = 1\text{ W}$, $f = 1\text{ kHz}$		52 K		Ω
Noise Output Voltage	V_{NO}	$V_{CC} = \pm 29\text{ V}$, $R_g = 10\text{ k}\Omega$		0.3	0.5	mVrms
Noise Voltage	V_N	$V_{CC} = \pm 29\text{ V}$	-70		+70	mV

Typical Characteristics

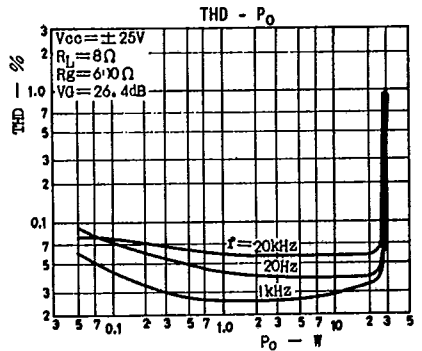
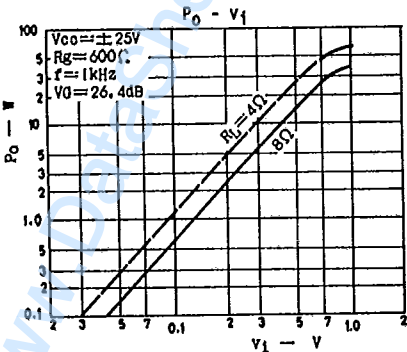

Typical Characteristics (Cont.)

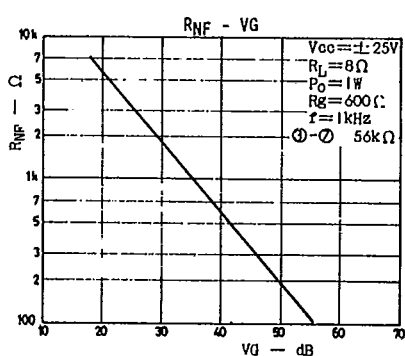
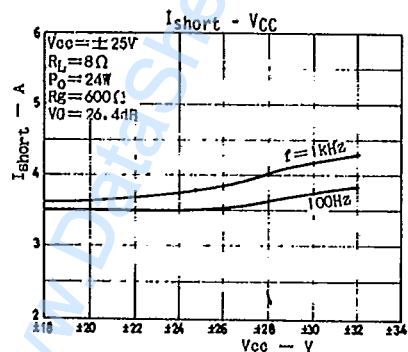
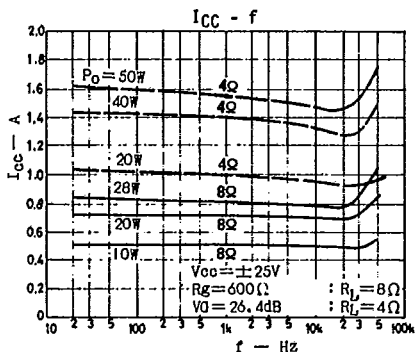
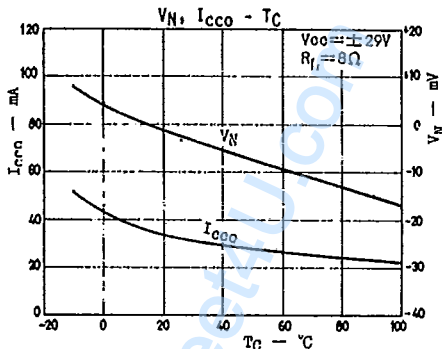
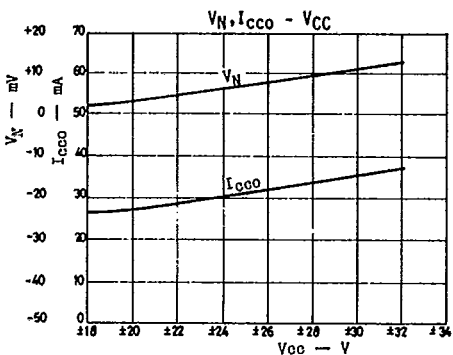
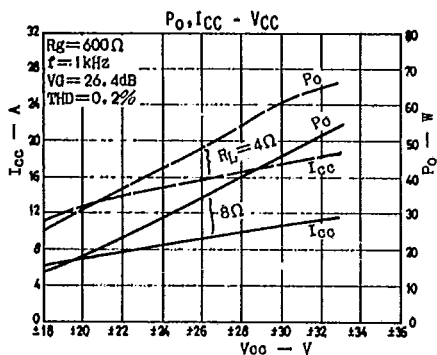
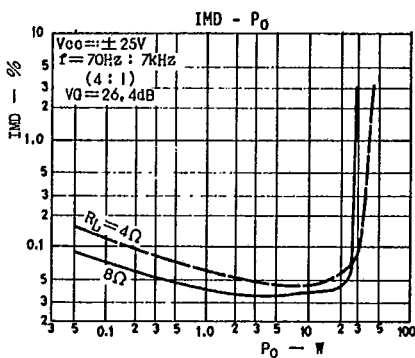
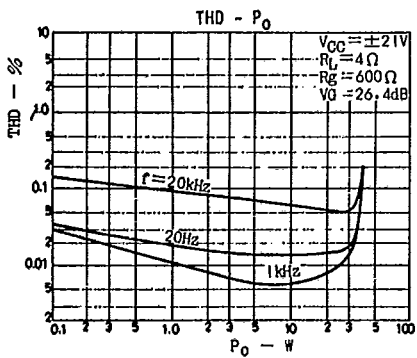

Typical Characteristics (Cont.)

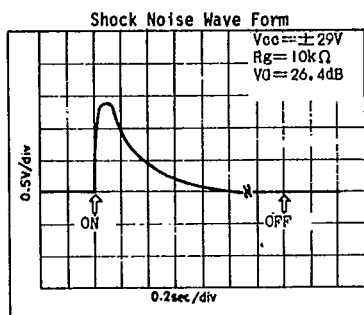
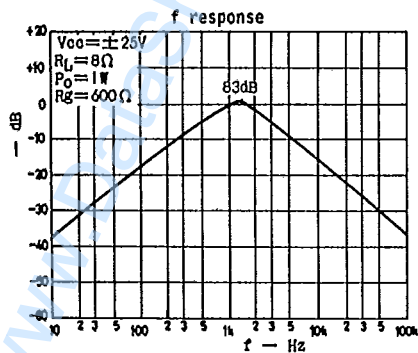
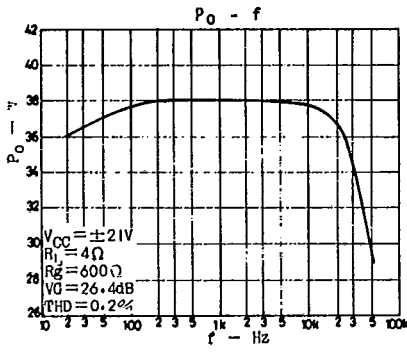
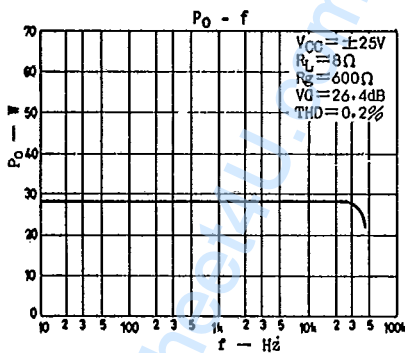
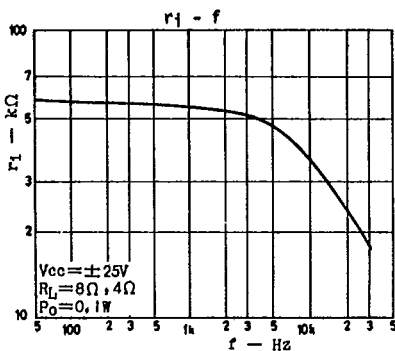
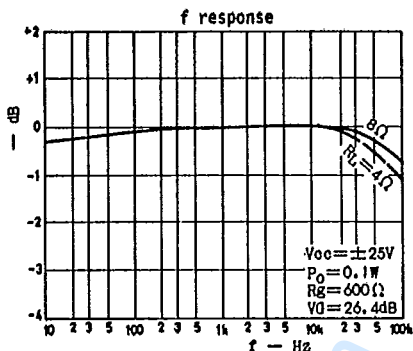
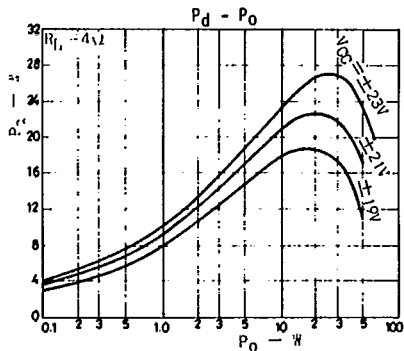
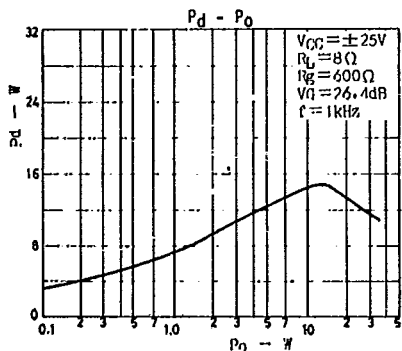

Typical Characteristics (Cont.)

