

Thyristors

SKT 1000 SKT 1200



V _{RSM}	V _{RRM} V _{DRM}	$\left(\frac{dv}{dt}\right)_{cr}$	I _{T(RMS)} (maximum values for continuous operation)	
			2300 A	2800 A
V	V	V/μs	I _{TAV} (sin. 180; T _{case} = . . . ; DSC)	
			1465 A (58 °C)	1780 A (55 °C)
500	400	500	SKT 1000/04 D	SKT 1200/04 D
900	800	500	SKT 1000/08 D	–
1300	1200	5 00	–	SKT 1200/12 D
		1000		SKT 1200/12 E
1500	1400	1000	SKT 1000/14 E	SKT 1200/14 E
1700	1600	1000	SKT 1000/16 E	SKT 1200/16 E
1900	1800	1000	SKT 1000/18 E	SKT 1200/18 E
2300	2200	1000	SKT 1000/22 E L2	–
2700	2600	1000	SKT 1000/26 E L2	–
2900	2800	1000	SKT 1000/28 E L2	–

Symbol	Conditions	SKT 1000	SKT 1200
I _{TAV}	sin. 180; T _{case} = 85 °C; DSC	1000 A	1200 A
I _{TSM}	T _{vj} = 25 °C: 10 ms T _{vj} = 125 °C: 10 ms	19 000 A 16 500 A	30 000 A 25 500 A
i ² t	T _{vj} = 25 °C: 8,3 ... 10 ms T _{vj} = 125 °C: 8,3 ... 10 ms	1800 kA ² s 1360 kA ² s	4500 kA ² s 3250 kA ² s
t _{gd} t _{gr} (di/dt) _{cr}	T _{vj} = 25 °C; I _G = 1 A; di _G /dt = 1 A/μs V _D = 0,67 · V _{DRM} f = 50 . . . 60 Hz		typ. 1 μs typ. 2 μs 125 A/μs
I _H	T _{vj} = 25 °C; typ./max.	250 mA/500 mA	
I _L	T _{vj} = 25 °C; R _G = 33 Ω; typ./max.	500 mA/2 A	
t _q	T _{vj} = 125 °C; typ.	100 ... 250 μs	
V _T	T _{vj} = 25 °C; I _T = 3600 A; max.	2,0 V	1,65 V
V _{T(TO)}	T _{vj} = 125 °C	1,14 V	0,95 V
r _T	T _{vj} = 125 °C	0,243 mΩ	0,18 mΩ
I _{DD} , I _{RD}	T _{vj} = 125 °C; V _{DD} = V _{DRM} ; V _{RD} = V _{RRM}	100 mA	100 mA
V _{GT}	T _{vj} = 25 °C		5
I _{GT}	T _{vj} = 25 °C		250 mA
V _{GD}	T _{vj} = 125 °C		0,25 V
I _{GD}	T _{vj} = 125 °C		10 mA
R _{thjc}	cont. sin. 180; DSC/SSC rec. 120; DSC/SSC		0,021 °C/W 0,0225/0,054 °C/W 0,027/0,060 °C/W
R _{thch} T _{vj} T _{stg}	DSC/SSC		0,005/0,010 °C/W – 40 ... +125 °C – 40 ... +130 °C
F	SI units US units		22 ... 25 kN 5000 ... 5600 lbs.
w			550 g
Case			B 14

Features

- Hermetic metal cases with ceramic insulators
- Capsule packages for double sided cooling
- International standard cases
- Off-state and reverse voltages up to 2800 V

Typical Applications

- DC motor control (e. g. for machine tools)
- Controlled rectifiers (e. g. for battery charging)
- AC controllers (e. g. for temperature control)

V

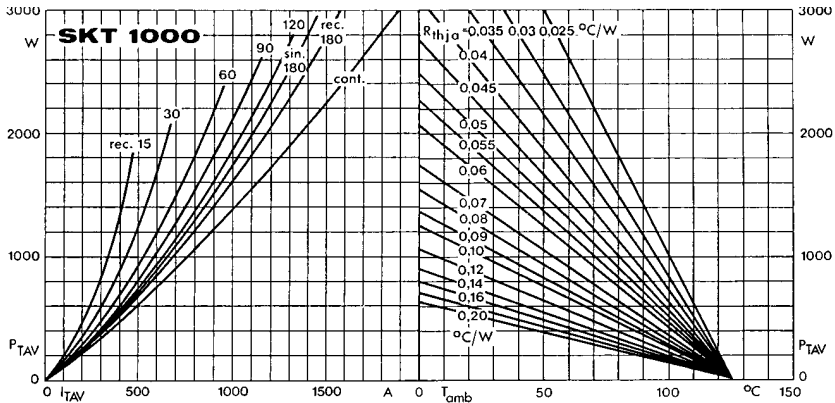

Fig. 1 a Power dissipation vs. on-state current and ambient temperature

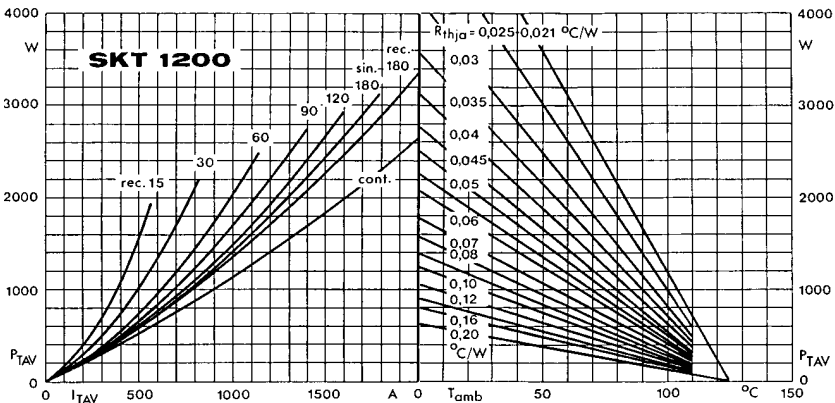

Fig. 1 b Power dissipation vs. on-state current and ambient temperature

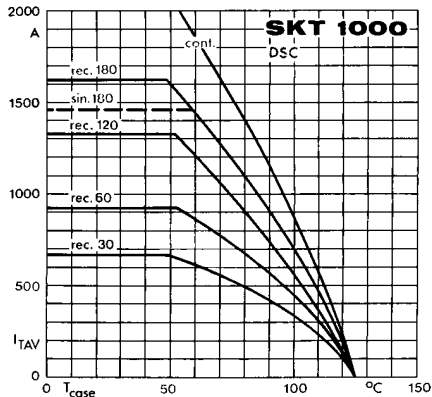

Fig. 2 a Rated on-state current vs. case temperature

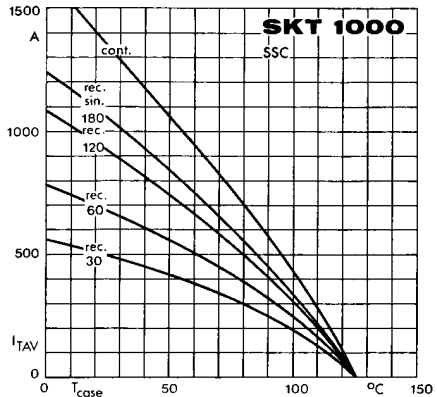

Fig. 2 b Rated on-state current vs. case temperature

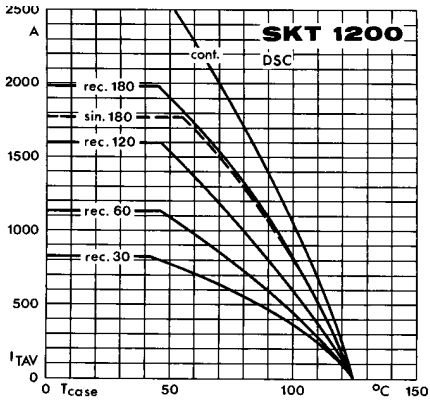

Fig. 2 c Rated on-state current vs. case temperature

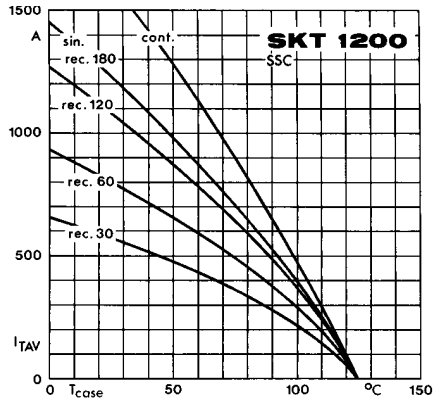

Fig. 2 d Rated on-state current vs. case temperature

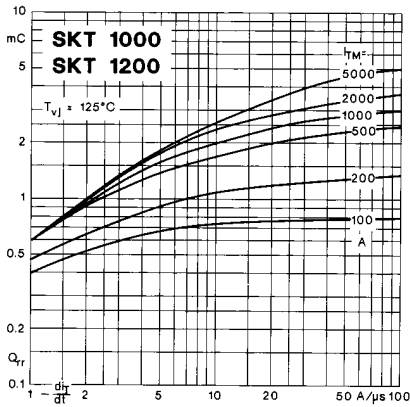

Fig. 3 Recovered charge vs. current decrease

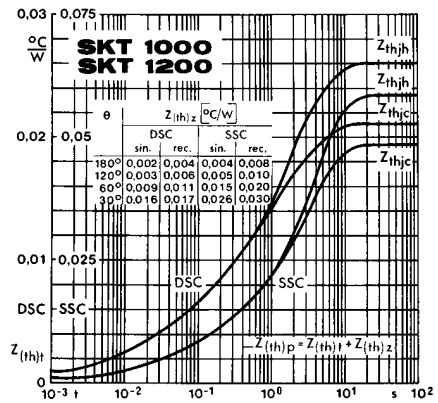

Fig. 4 Transient thermal impedance vs. time

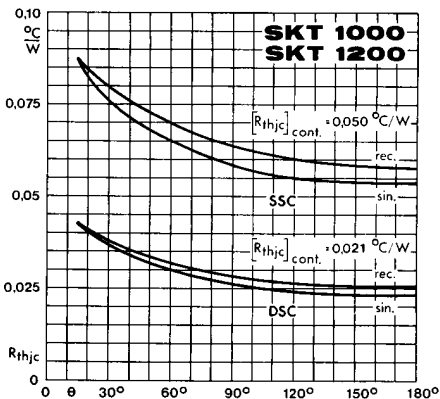

Fig. 5 Thermal resistance vs. conduction angle

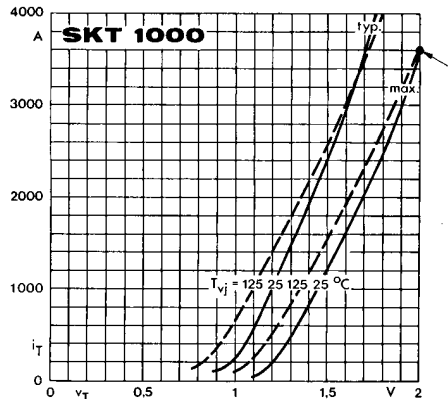

Fig. 6 a On-state characteristics

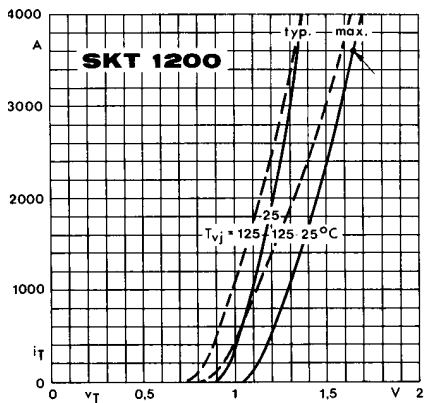

Fig. 6 b On-state characteristics

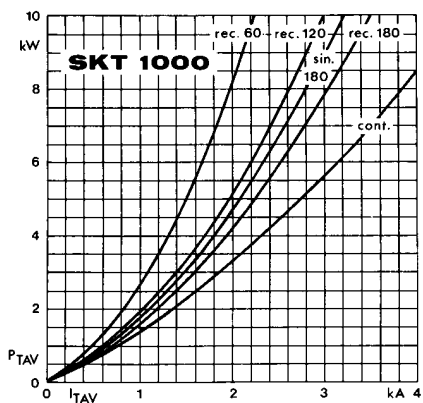

Fig. 7 a Power dissipation vs. on-state current

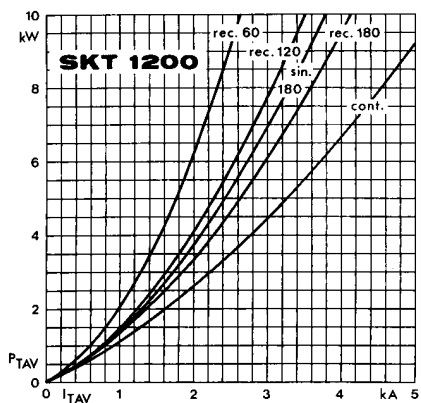

Fig. 7 b Power dissipation vs. on-state current

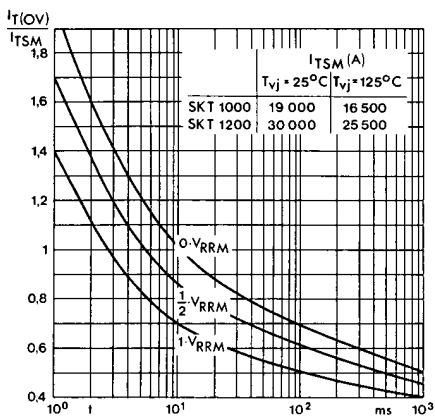

Fig. 8 Surge overload current vs. time

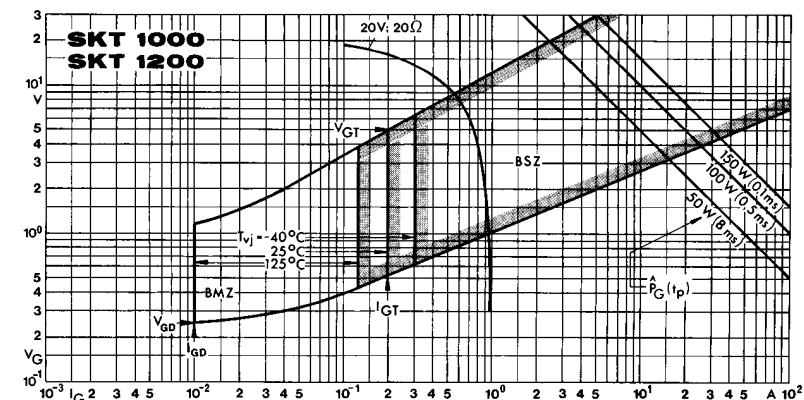
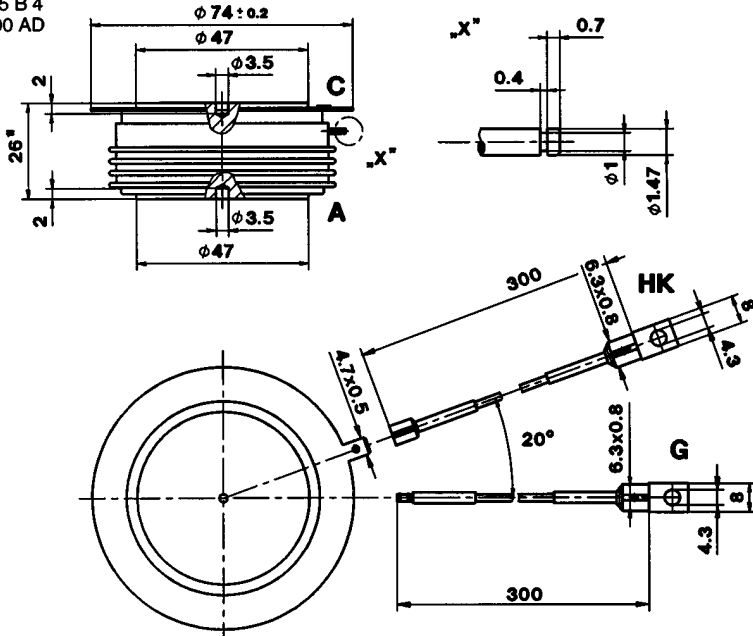

Fig. 9 Gate trigger characteristics

SKT 1000
SKT 1200

Case B 14

DIN 41814: 155 B 4
JEDEC: TO-200 AD



1) SKT 1000/... L 2: 27,5 mm

- C: Cathode terminal
- A: Anode terminal
- G: Gate terminal (yellow sleeve)
- HK: Auxiliary cathode terminal (red sleeve)

Dimensions in mm

