

DATA SHEET

NEC

NPN SILICON RF TRANSISTOR **2SC4093**

NPN EPITAXIAL SILICON RF TRANSISTOR FOR HIGH-FREQUENCY LOW-NOISE AMPLIFICATION 4-PIN MINIMOLD

DESCRIPTION

The 2SC4093 is an NPN silicon epitaxial transistor designed for low noise amplifier at VHF, UHF and CATV band. It has large dynamic range and good current characteristics, and is contained in a 4-pin minimold package which enables high-isolation gain.

FEATURES

- Low Noise
NF = 1.1 dB TYP. @ $V_{CE} = 10\text{ V}$, $I_C = 7\text{ mA}$, $f = 1\text{ GHz}$
- High Power gain
 $|S_{21e}|^2 = 13\text{ dB TYP. @ } V_{CE} = 10\text{ V}$, $I_C = 20\text{ mA}$, $f = 1\text{ GHz}$
- Maximum available power gain: MAG = 14.2 dB TYP. @ $V_{CE} = 10\text{ V}$, $I_C = 20\text{ mA}$, $f = 1\text{ GHz}$
- 4-pin minimold Package

★ ORDERING INFORMATION

Part Number	Quantity	Supplying Form
2SC4093	50 pcs (Non reel)	• 8 mm wide embossed taping • Pin 3 (Base), Pin 4 (Emitter) face to perforation side of the tape
2SC4093-T1	3 kpcs/reel	

Remark To order evaluation samples, contact your nearby sales office.
The unit sample quantity is 50 pcs.

ABSOLUTE MAXIMUM RATINGS ($T_A = +25^\circ\text{C}$)

Parameter	Symbol	Ratings	Unit
Collector to Base Voltage	V_{CBO}	20	V
Collector to Emitter Voltage	V_{CEO}	12	V
Emitter to Base Voltage	V_{EBO}	3.0	V
Collector Current	I_C	100	mA
Total Power Dissipation	P_{tot}^{Note}	200	mW
Junction Temperature	T_j	150	$^\circ\text{C}$
Storage Temperature	T_{stg}	-65 to +150	$^\circ\text{C}$

Note Free air

Caution Observe precautions when handling because these devices are sensitive to electrostatic discharge.

The information in this document is subject to change without notice. Before using this document, please confirm that this is the latest version.
Not all devices/types available in every country. Please check with local NEC Compound Semiconductor Devices representative for availability and additional information.

ELECTRICAL CHARACTERISTICS (T_A = +25°C)

Parameter	Symbol	Test Conditions	MIN.	TYP.	MAX.	Unit
DC Characteristics						
Collector Cut-off Current	I _{CBO}	V _{CB} = 10 V, I _E = 0 mA	–	–	1.0	μA
Emitter Cut-off Current	I _{EBO}	V _{EB} = 1 V, I _C = 0 mA	–	–	1.0	μA
DC Current Gain	h _{FE} ^{Note 1}	V _{CE} = 10 V, I _C = 20 mA	50	120	250	–
RF Characteristics						
Gain Bandwidth Product	f _T	V _{CE} = 10 V, I _C = 20 mA	–	7.0	–	GHz
Insertion Power Gain	S _{21e} ²	V _{CE} = 10 V, I _C = 20 mA, f = 1.0 GHz	11	13	–	dB
Noise Figure	NF	V _{CE} = 10 V, I _C = 7 mA, f = 1.0 GHz	–	1.1	2.0	dB
Reverse Transfer Capacitance	C _{re} ^{Note 2}	V _{CB} = 10 V, I _E = 0 mA, f = 1.0 MHz	–	0.6	0.95	pF

- Notes 1.** Pulse measurement: PW ≤ 350 μs, Duty Cycle ≤ 2%
2. Collector to base capacitance when the emitter grounded

h_{FE} CLASSIFICATION

Rank	R26/RBF ^{Note}	R27/RBG ^{Note}	R28/RBH ^{Note}
Marking	R26	R27	R28
Range	50 to 100	80 to 160	125 to 250

Note Old Specification / New Specification

TYPICAL CHARACTERISTICS (T_A = +25°C, unless otherwise specified)

TOTAL POWER DISSIPATION vs. AMBIENT TEMPERATURE

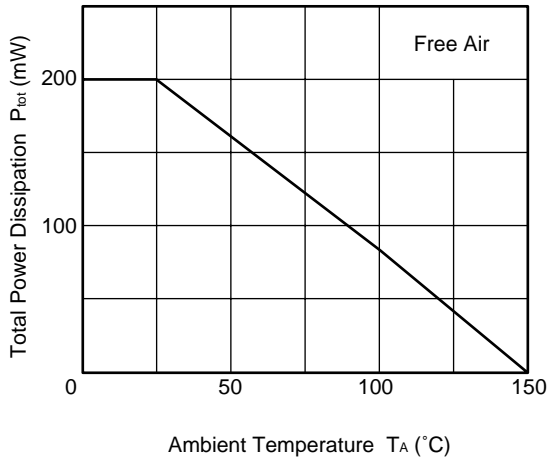

REVERSE TRANSFER CAPACITANCE vs. COLLECTOR TO BASE VOLTAGE

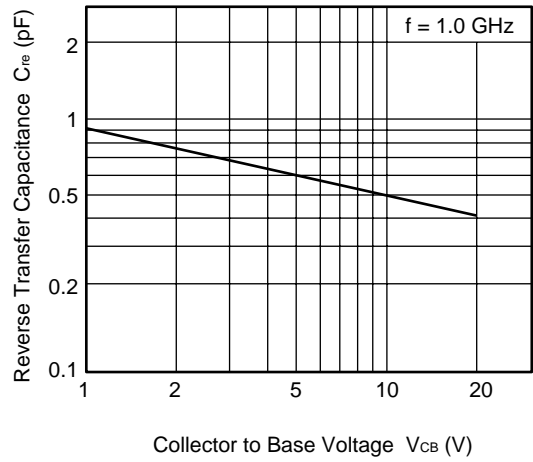

DC CURRENT GAIN vs. COLLECTOR CURRENT

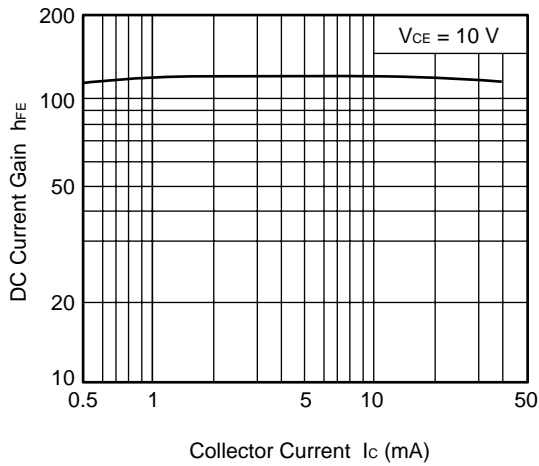

GAIN BANDWIDTH PRODUCT vs. COLLECTOR CURRENT

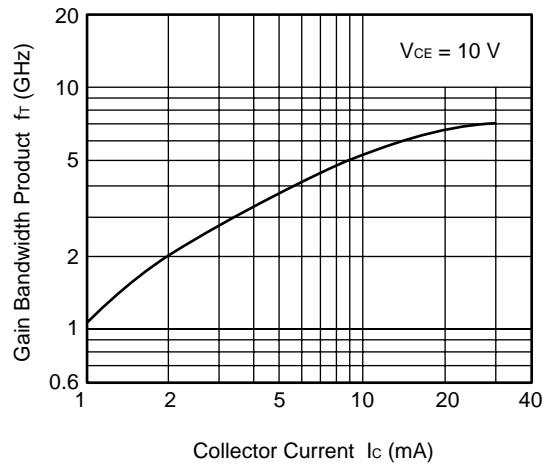

MAXIMUM GAIN/INSERTION POWER GAIN vs. FREQUENCY

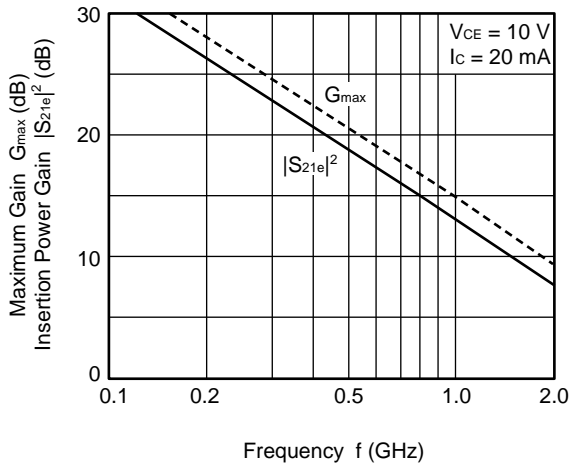

INSERTION POWER GAIN vs. COLLECTOR CURRENT

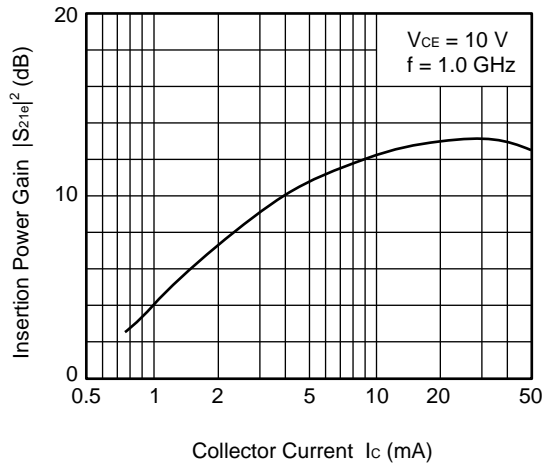

Remark The graphs indicate nominal characteristics.

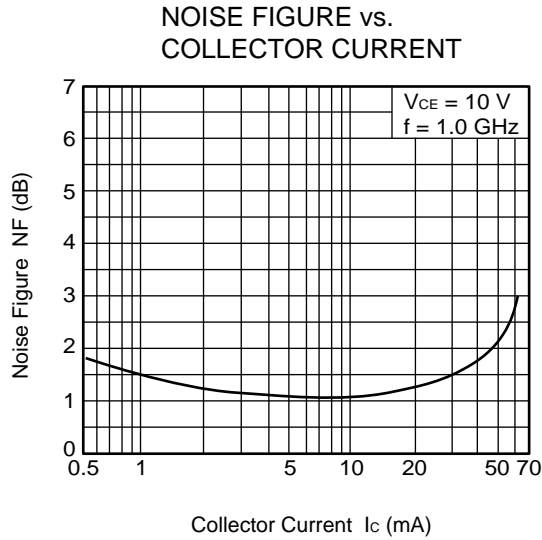

Remark The graph indicates nominal characteristics.

★ **S-PARAMETERS**

S-parameters/Noise parameters are provided on the NEC Compound Semiconductor Devices Web site in a form (S2P) that enables direct import to a microwave circuit simulator without keyboard input.

Click here to download S-parameters.

[RF and Microwave] → [Device Parameters]

URL <http://www.ncsd.necel.com/>

★ PACKAGE DIMENSIONS

4-PIN MINIMOLD PACKAGE (UNIT: mm)

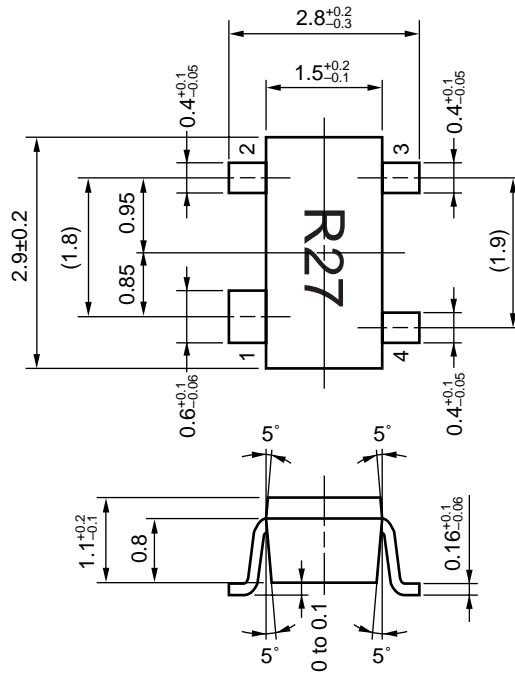

PIN CONNECTIONS

- 1. Collector
- 2. Emitter
- 3. Base
- 4. Emitter

- **The information in this document is current as of October, 2004. The information is subject to change without notice. For actual design-in, refer to the latest publications of NEC's data sheets or data books, etc., for the most up-to-date specifications of NEC semiconductor products. Not all products and/or types are available in every country. Please check with an NEC sales representative for availability and additional information.**
 - No part of this document may be copied or reproduced in any form or by any means without prior written consent of NEC. NEC assumes no responsibility for any errors that may appear in this document.
 - NEC does not assume any liability for infringement of patents, copyrights or other intellectual property rights of third parties by or arising from the use of NEC semiconductor products listed in this document or any other liability arising from the use of such products. No license, express, implied or otherwise, is granted under any patents, copyrights or other intellectual property rights of NEC or others.
 - Descriptions of circuits, software and other related information in this document are provided for illustrative purposes in semiconductor product operation and application examples. The incorporation of these circuits, software and information in the design of customer's equipment shall be done under the full responsibility of customer. NEC assumes no responsibility for any losses incurred by customers or third parties arising from the use of these circuits, software and information.
 - While NEC endeavours to enhance the quality, reliability and safety of NEC semiconductor products, customers agree and acknowledge that the possibility of defects thereof cannot be eliminated entirely. To minimize risks of damage to property or injury (including death) to persons arising from defects in NEC semiconductor products, customers must incorporate sufficient safety measures in their design, such as redundancy, fire-containment, and anti-failure features.
 - NEC semiconductor products are classified into the following three quality grades:
 "Standard", "Special" and "Specific". The "Specific" quality grade applies only to semiconductor products developed based on a customer-designated "quality assurance program" for a specific application. The recommended applications of a semiconductor product depend on its quality grade, as indicated below. Customers must check the quality grade of each semiconductor product before using it in a particular application.
 "Standard": Computers, office equipment, communications equipment, test and measurement equipment, audio and visual equipment, home electronic appliances, machine tools, personal electronic equipment and industrial robots
 "Special": Transportation equipment (automobiles, trains, ships, etc.), traffic control systems, anti-disaster systems, anti-crime systems, safety equipment and medical equipment (not specifically designed for life support)
 "Specific": Aircraft, aerospace equipment, submersible repeaters, nuclear reactor control systems, life support systems and medical equipment for life support, etc.
- The quality grade of NEC semiconductor products is "Standard" unless otherwise expressly specified in NEC's data sheets or data books, etc. If customers wish to use NEC semiconductor products in applications not intended by NEC, they must contact an NEC sales representative in advance to determine NEC's willingness to support a given application.
- (Note)
- (1) "NEC" as used in this statement means NEC Corporation, NEC Compound Semiconductor Devices, Ltd. and also includes its majority-owned subsidiaries.
 - (2) "NEC semiconductor products" means any semiconductor product developed or manufactured by or for NEC (as defined above).

M8E 00.4-0110

► For further information, please contact

NEC Compound Semiconductor Devices, Ltd. <http://www.ncsd.necel.com/>

E-mail: salesinfo@ml.ncsd.necel.com (sales and general)

techinfo@ml.ncsd.necel.com (technical)

Sales Division TEL: +81-44-435-1588 FAX: +81-44-435-1579

NEC Compound Semiconductor Devices Hong Kong Limited

E-mail: ncsd-hk@elhk.nec.com.hk (sales, technical and general)

Hong Kong Head Office TEL: +852-3107-7303 FAX: +852-3107-7309

Taipei Branch Office TEL: +886-2-8712-0478 FAX: +886-2-2545-3859

Korea Branch Office TEL: +82-2-558-2120 FAX: +82-2-558-5209

NEC Electronics (Europe) GmbH <http://www.ee.nec.de/>

TEL: +49-211-6503-0 FAX: +49-211-6503-1327

California Eastern Laboratories, Inc. <http://www.cel.com/>

TEL: +1-408-988-3500 FAX: +1-408-988-0279