

Cylinder Type Lithium Ion Capacitors

LIC1235R3R8406

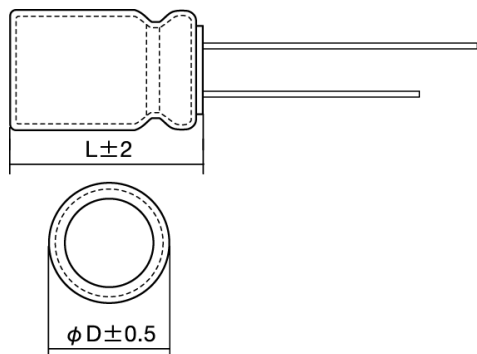

■ Features

- Item Summary
3.8(3.5)V, 2.2V, 40F±20%, Less than 0.15Ω
- Lifecycle Stage
Mass Production

■ Products characteristics table

Temperature Range	-25 to +70(+85)℃
Maximum Usable Voltage	3.8(3.5)V
Min. Voltage	2.2V
Nominal Capacity	40F
Internal Resistance	0.15Ω
Initial Capacitance	40F±20%
Initial Internal Resistance	Less than 0.15Ω
RoHS Compliance	Yes
Soldering Method	Manual

2014.04.24

The data is reference only. Electrical characteristics vary depending on environment or measurement condition.
 TAIYO YUDEN reserves the right to make change to the Date at any time without notice.
 Before making final selection, please check product specification.