



# M.C.C.

Micro Commercial Components™

Micro Commercial Components  
20736 Marilla Street Chatsworth  
CA 91311  
Phone: (818) 701-4933  
Fax: (818) 701-4939

## B5817WS Thru B5819WS

## 1 Amp Schottky Barrier Rectifier 20 - 40 Volts

### Features

- Halogen free available upon request by adding suffix "-HF"
- Guard Ring Protection
- Low Forward Voltage Drop
- For Use in Low Voltage, High Frequency Inverters
- High Surge Current Capability
- Epoxy meets UL 94 V-0 flammability rating
- Moisture Sensitivity Level 1
- Lead Free Finish/RoHS Compliant("P" Suffix designates RoHS Compliant. See ordering information)

### Maximum Ratings

- Operating Temperature: -65°C to +125°C
- Storage Temperature: -65°C to +150°C
- Maximum Thermal Resistance; 500°C/W Junction To Ambient

MCC Part Number	Device Marking	Maximum Recurrent Peak Reverse Voltage	Maximum RMS Voltage	Maximum DC Blocking Voltage
B5817WS	SJ	20V	14V	20V
B5818WS	SK	30V	21V	30V
B5819WS	SL	40V	28V	40V

### Electrical Characteristics @ 25°C Unless Otherwise Specified

Average Forward Current	$I_{F(AV)}$	1.0A	$T_c = 90^\circ C$
Peak Forward Surge Current	$I_{FSM}$	10A	8.3ms, half sine
Maximum Instantaneous Forward Voltage	$V_F$	0.45V	$I_{FM} = 1.0A;$ $T_J = 25^\circ C$ (Note 1)
B5817WS		0.55V	
B5818WS		0.60V	$I_{FM} = 3A;$ $T_J = 25^\circ C$ (Note 1)
B5819WS		0.75V	
Maximum DC Reverse Current At Rated DC Blocking Voltage	$I_R$	1mA	$T_A = 25^\circ C$
Typical junction capacitance	$C_J$	120pF	Measured at 1.0MHz, $V_R=4.0V$

Notes: 1. Pulse Test: Pulse Width 300usec, Duty Cycle 2%

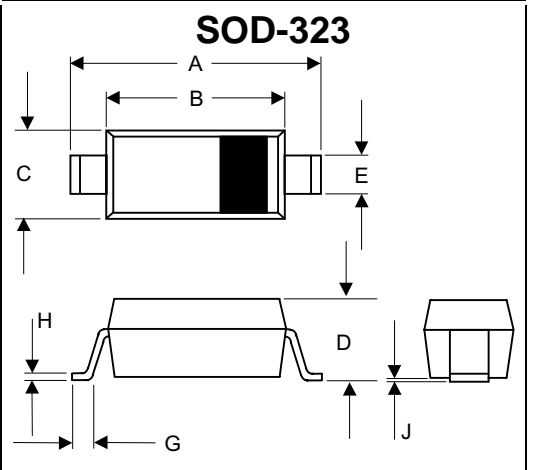

DIM	INCHES		MM		NOTE
	MIN	MAX	MIN	MAX	
A	.090	.107	2.30	2.70	
B	.063	.071	1.60	1.80	
C	.045	.053	1.15	1.35	
D	.031	.045	0.80	1.15	
E	.010	.016	0.25	0.40	
G	.004	.018	0.10	0.45	
H	.004	.010	0.10	0.25	
J	-----	.006	-----	0.15	

#### SUGGESTED SOLDER PAD LAYOUT

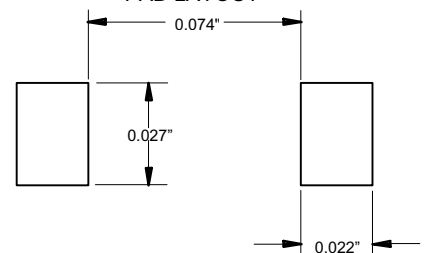

Typical Characteristics

Fig. 1 - Forward Current Derating Curve

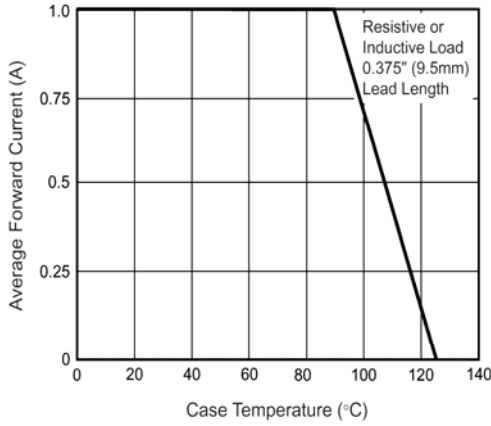

Fig. 2 - Maximum Non-Repetitive Peak Forward Surge Current

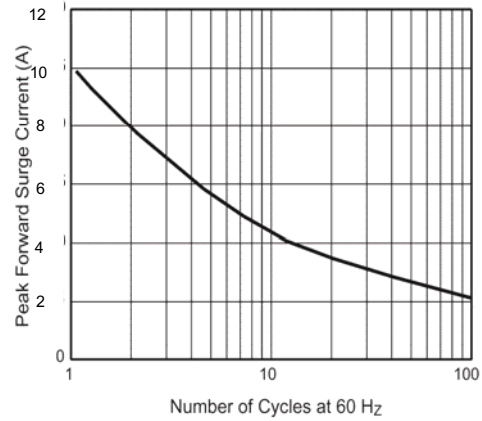

Fig. 3 - Typical Instantaneous Forward Characteristics

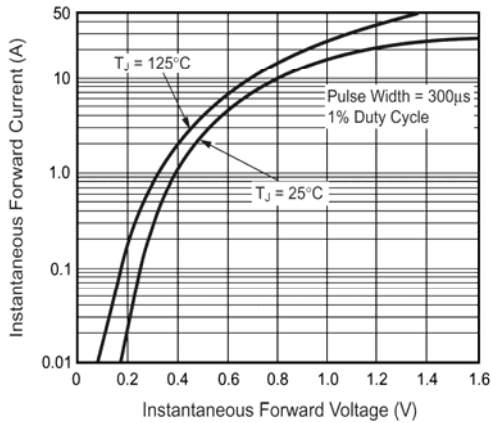

Fig. 4 - Typical Reverse Characteristics

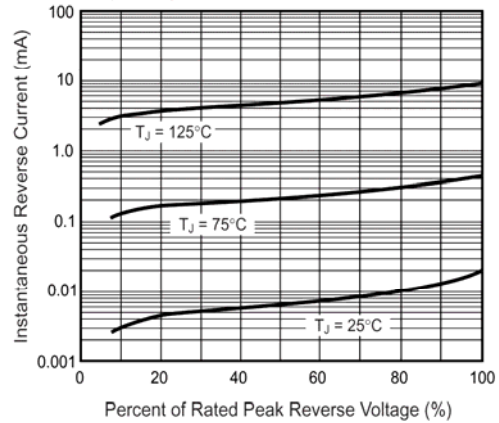

Fig. 5 - Typical Junction Capacitance

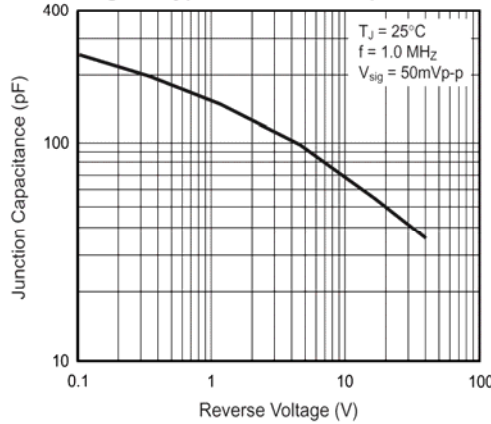
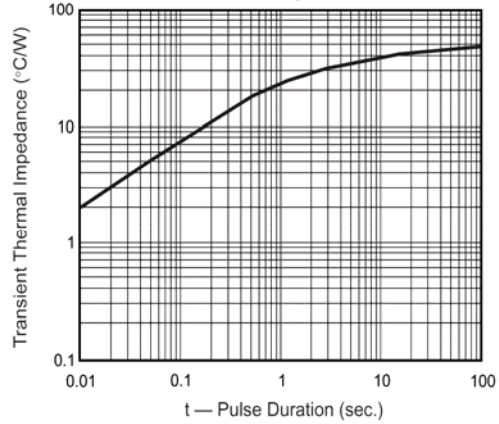

Fig. 6 - Typical Transient Thermal Impedance





Micro Commercial Components

Ordering Information :

Device	Packing
Part Number-TP	Tape&Reel: 3Kpcs/Reel

**\*\*\*IMPORTANT NOTICE\*\*\***

**Micro Commercial Components Corp.** reserves the right to make changes without further notice to any product herein to make corrections, modifications , enhancements , improvements , or other changes . **Micro Commercial Components Corp .** does not assume any liability arising out of the application or use of any product described herein; neither does it convey any license under its patent rights ,nor the rights of others . The user of products in such applications shall assume all risks of such use and will agree to hold **Micro Commercial Components Corp .** and all the companies whose products are represented on our website, harmless against all damages.

**\*\*\*LIFE SUPPORT\*\*\***

MCC's products are not authorized for use as critical components in life support devices or systems without the express written approval of Micro Commercial Components Corporation.

**\*\*\*CUSTOMER AWARENESS\*\*\***

Counterfeiting of semiconductor parts is a growing problem in the industry. Micro Commercial Components (MCC) is taking strong measures to protect ourselves and our customers from the proliferation of counterfeit parts. MCC strongly encourages customers to purchase MCC parts either directly from MCC or from Authorized MCC Distributors who are listed by country on our web page cited below. Products customers buy either from MCC directly or from Authorized MCC Distributors are genuine parts, have full traceability, meet MCC's quality standards for handling and storage. **MCC will not provide any warranty coverage or other assistance for parts bought from Unauthorized Sources.** MCC is committed to combat this global problem and encourage our customers to do their part in stopping this practice by buying direct or from authorized distributors.