

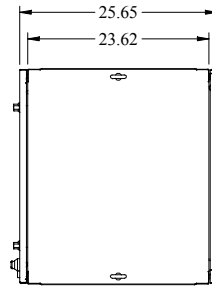

PART No. IPC1676ST
 for more information visit
www.hammondmfg.com
 Data subject to change without notice
 Isometric drawing Not to Scale

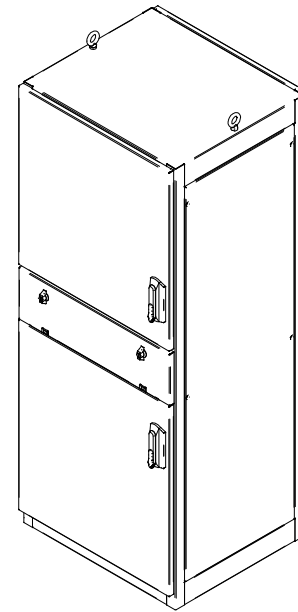

TOP VIEW

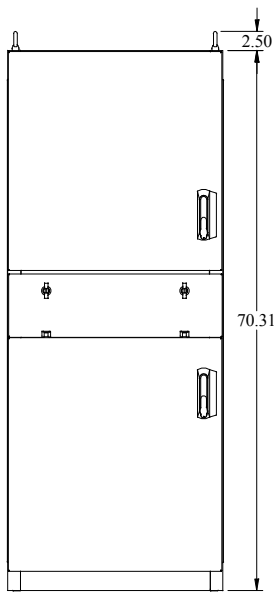

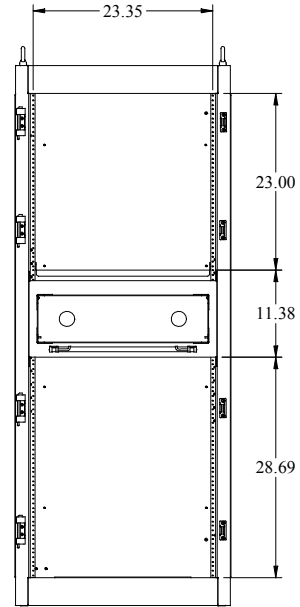
FRONT VIEW



FRONT DOORS REMOVED



LEFT SIDE VIEW

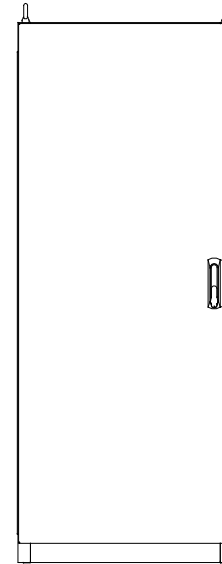

REAR VIEW

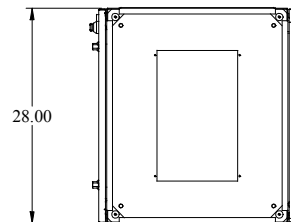

BOTTOM VIEW