

SuperFlux LEDs

Lead-Free



Introduction

The popular through-hole package design allows lighting designers to reduce the number of LEDs required and provide a more uniform and unique illuminated appearance than with other LED products. This is possible through the efficient optical package design and high-current capabilities.

The low profile package can be easily coupled with reflectors or lenses to efficiently distribute light and provide the desired appearance. This product family includes red, red-orange and amber LEDs, allowing lighting designers to match the color of many lighting applications like vehicle signal lamps, specialty lighting, and electronic signs.

Features

- Rugged package
- Energy saving
- Ease of handling
- Lead-Free
- RoHS Compliant
- High Luminance
- Uniform Color
- Low Power Consumption

Key Applications

- Automotive
 - Central High Mount Stop Lamp (CHMSL)
 - Stop Lamp
- Illumination
 - Signal Lamps

Table of Contents

Selection Guide	2
Absolute Maximum Ratings	2
Mechanical Dimensions	3
Optical Characteristics	4
Electrical Characteristics	5
Figures	6
Recommended Soldering Conditions for Pb-Free SuperFlux.	11
Product Binning and Labeling	12
Part Number Selection	13

Selection Guide

Table 1. Device Type Overview

LED Color	Device Type	Typical Total Included Angle ⁽¹⁾ (degrees) $\theta_{0.90V}$
Red	HPWT-RDx2	44 X 88
	HPWT-MDx2	100
	HPWT-DDx2	70
	HPWT-BDx2	50
Red-Orange	HPWT-RHx2	44 X 88
	HPWT-MHx2	100
	HPWT-DHx2	70
	HPWT-BHx2	50
Amber	HPWT-RLx2	44 X 88
	HPWT-MLx2	100
	HPWT-DLx2	70
	HPWT-BLx2	50

Notes for Table 1:

- $\theta_{0.90V}$ is the included angle at which 90% of the total luminous flux is captured.

Absolute Maximum Ratings

Table 2.

Parameter	HPWT	Units
DC Forward Current ⁽¹⁾	70	mA
Power Dissipation	221	mW
Reverse Voltage (IR = 100 μ A)	10	V
Operating Temperature Range	-40 - +100	$^{\circ}$ C
Storage Temperature Range	-55 - +100	$^{\circ}$ C
High Temperature Chamber	125 $^{\circ}$ C, 2 hours	
LED Junction Temperature	125 $^{\circ}$ C	

Notes for Table 2:

- Derate as shown in Figures 4.

Mechanical Dimensions

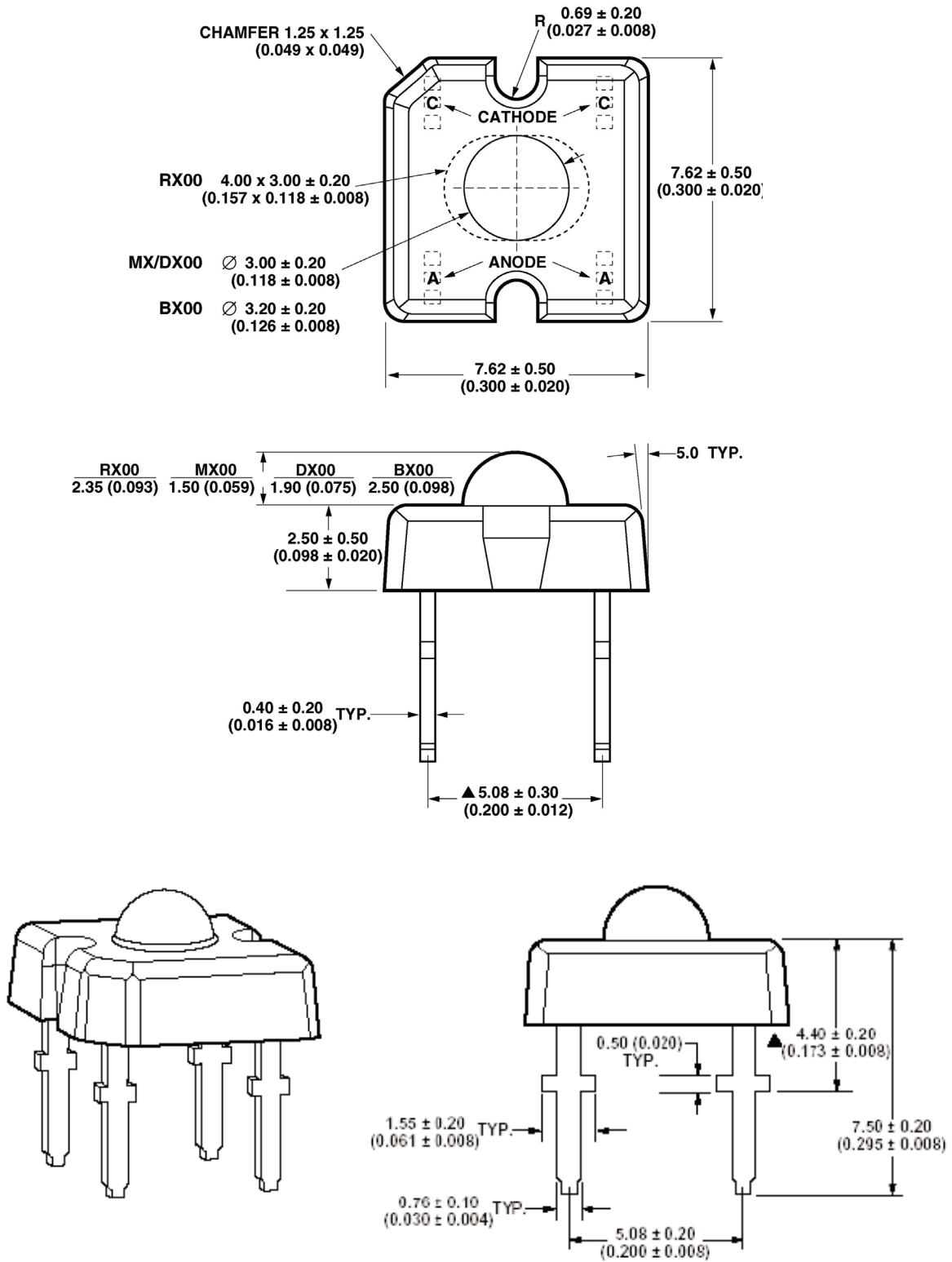

Figure 1. Package outline drawing.

Optical Characteristics

Optical Characteristics at $T_A = 25^\circ\text{C}$, $I_F = 70\text{ mA}$, $R\theta_{J-A} = 200^\circ\text{C/W}$

Table 3.

LED Color	Device Type	Typ. Peak Wavelength λ_{peak} (nm)	Typ. Dominant Wavelength λ_{dom} (nm) ^[1]	Typical Total Included Angle ^[2] (degrees) $\theta_{0.90V}$	Luminous Intensity Total Flux $I_v(\text{cd})/\Phi_v(\text{lm})$	Viewing Angle (degrees) $2\theta_{1/2}$
Red	HPWT-RDx2	640	630	44 X 88	1.25	25 X 68
	HPWT-MDx2	640	630	100	0.6	70
	HPWT-DDx2	640	630	70	1.5	40
	HPWT-BDx2	640	630	50	2.0	30
Red-Orange	HPWT-RHx2	626	620	44 X 88	1.25	25 X 68
	HPWT-MHx2	626	620	100	0.6	70
	HPWT-DHx2	626	620	70	1.5	40
	HPWT-BHx2	626	620	50	2.0	30
Amber	HPWT-RLx2	596	594	44 X 88	1.25	25 X 68
	HPWT-MLx2	596	594	100	0.6	70
	HPWT-DLx2	596	594	70	1.5	40
	HPWT-BLx2	596	594	50	2.0	30

Notes for Table 3:

1. The dominant wavelength is derived from the CIE Chromaticity Diagram and represents the perceived color of the device.
2. $\theta_{0.90V}$ is the included angle at which 90% of the total luminous flux is captured.

Electrical Characteristics

Electrical Characteristics at $T_A = 25^\circ\text{C}$

Table 4.

LED Color	Device Type	Forward Voltage V_f ^[1] (Volts) $I_F = 70 \text{ mA}$ (HPWT)			Reverse Breakdown @ V_R (Volts) ^[1] @ $I_R = 100 \mu\text{A}$		Capacitance C (pF) $V_F = 0$ $F = 1 \text{ MHz}$.	Typical Thermal Resistance ($^\circ\text{C/W}$) $R\theta_{J-PIN}$	Typ. Speed of Response τ_s (ns) ^[2]
		Min	Typ	Max	Min	Typ			
Red	HPWT-xDx2	2.19	2.6	3.03	10	20	40	125	20
Red-Orange	HPWT-xHx2	2.19	2.6	3.03	10	20	40	125	20
Amber	HPWT-xLx2	2.19	2.6	3.15	10	20	40	125	20

Notes for Table 4:

1. Operation in reverse bias is not recommended.
2. τ_s is the time constant, τ_s/τ_s .

Figures

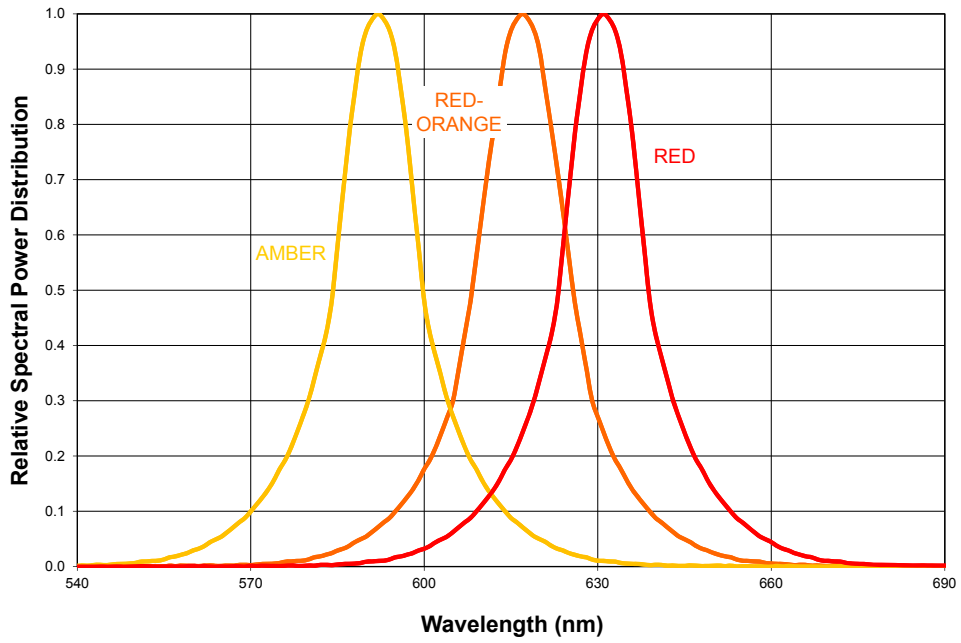

Figure 2. Relative intensity vs. wavelength.

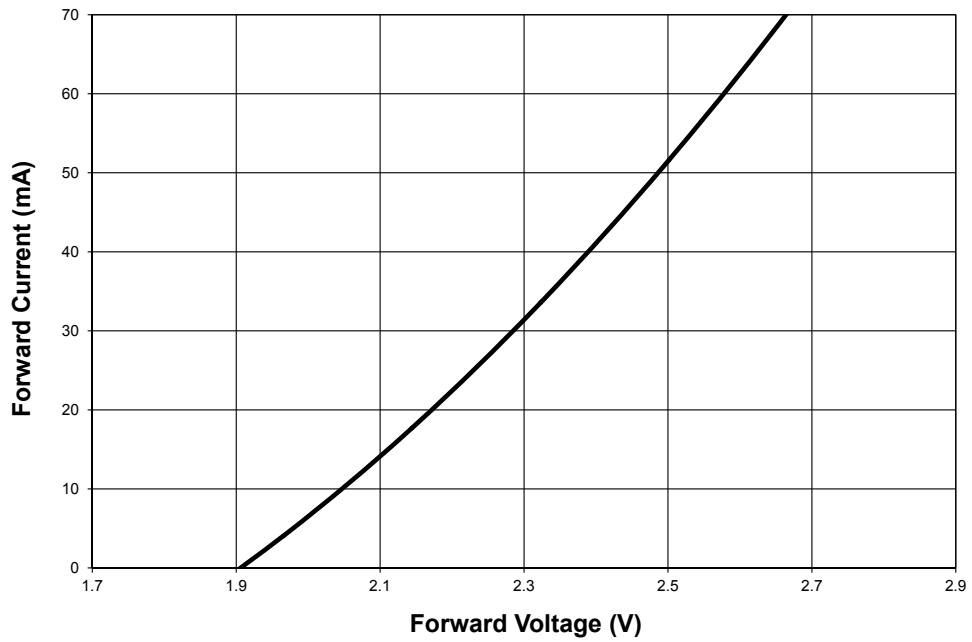

Figure 3. Forward current vs. forward voltage.

Figures, Continued

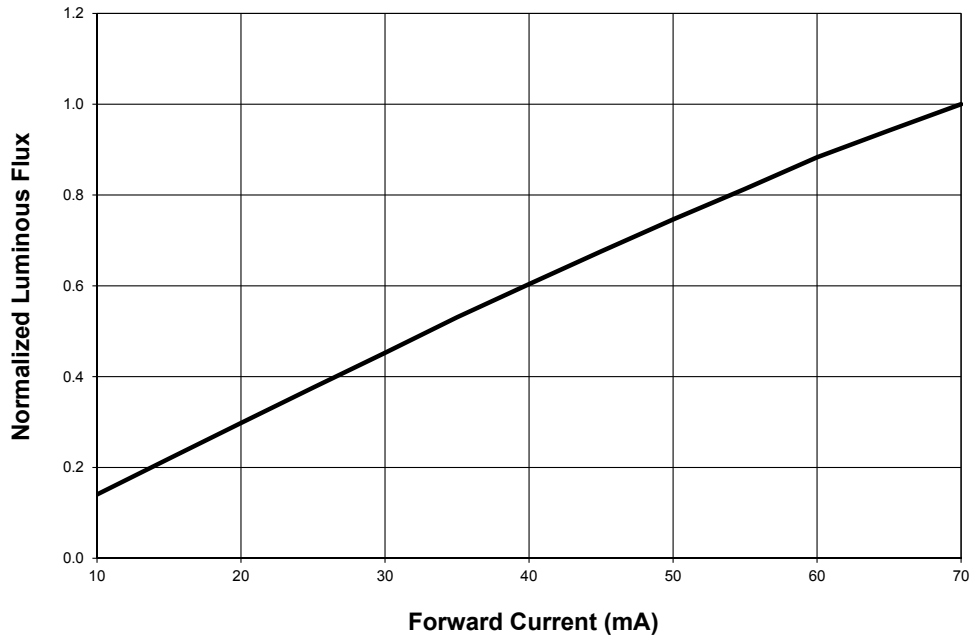

Figure 4. Typical luminous flux vs. forward current for Superflux.

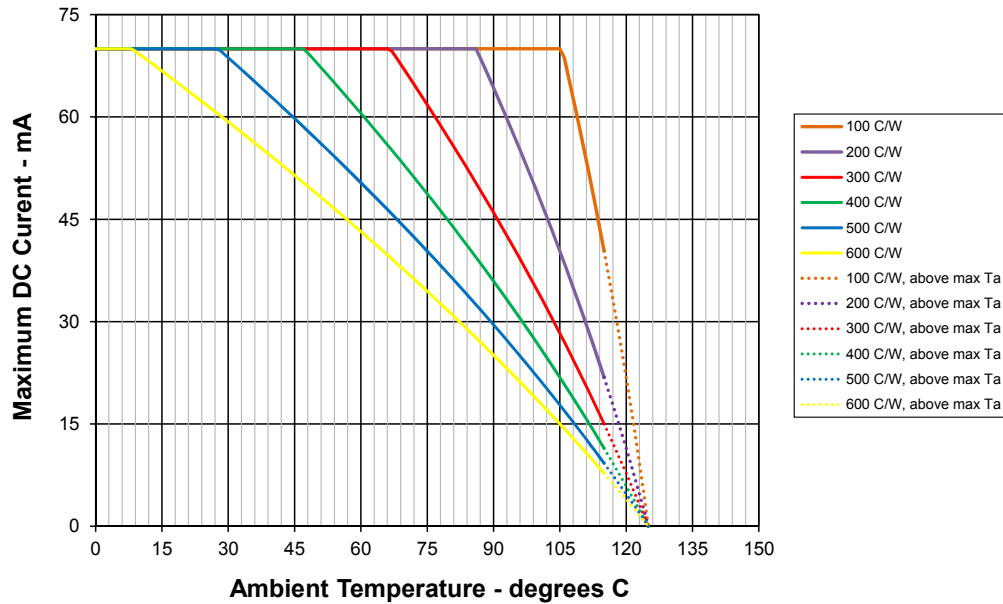

Figure 5. HPWT-xxxx relative luminous flux vs. forward current.

Figures, Continued

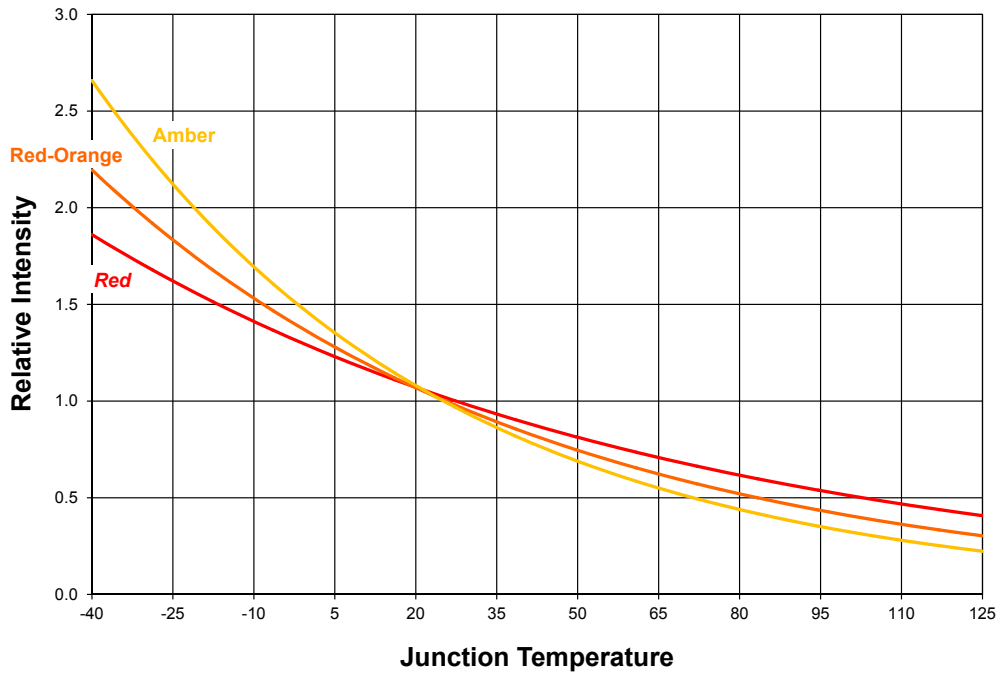

Figure 6. Luminous flux vs. junction temperature for superflux.

Figures, Continued

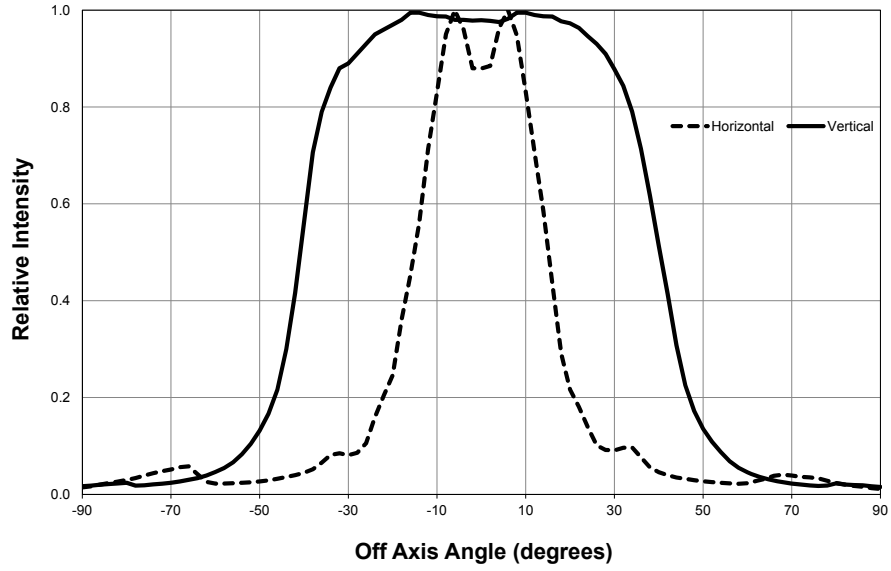

Figure 7a. HPWT-Rxxx relative luminous intensity vs. off axis angle.

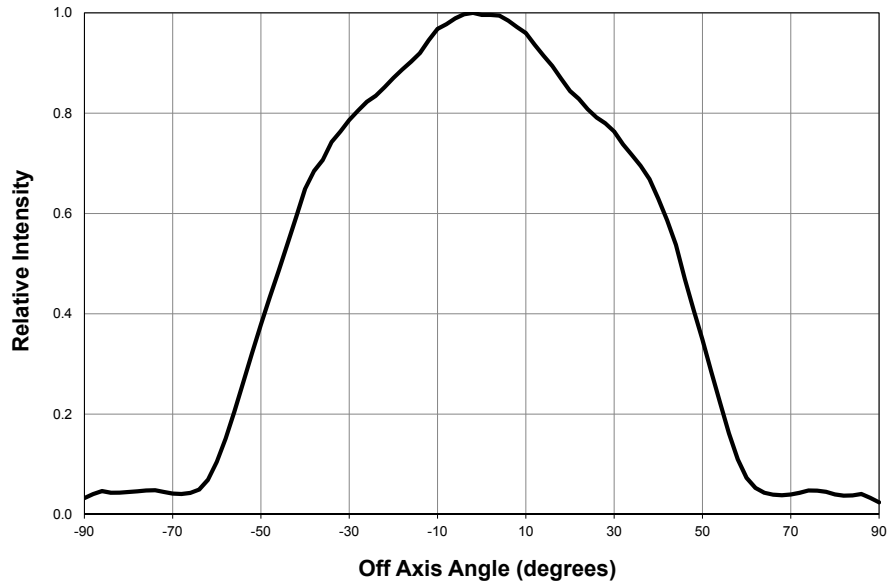

Figure 7b. HPWT-Mxxx relative luminous intensity vs. off axis angle.

Figures, Continued

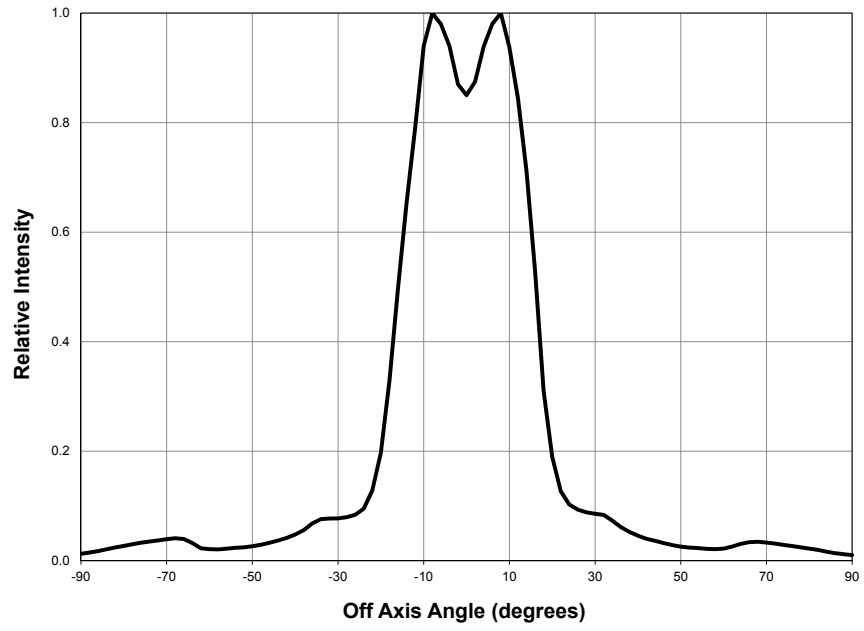

Figure 7c. HPWT-Bxxx relative luminous intensity vs. off axis angle.

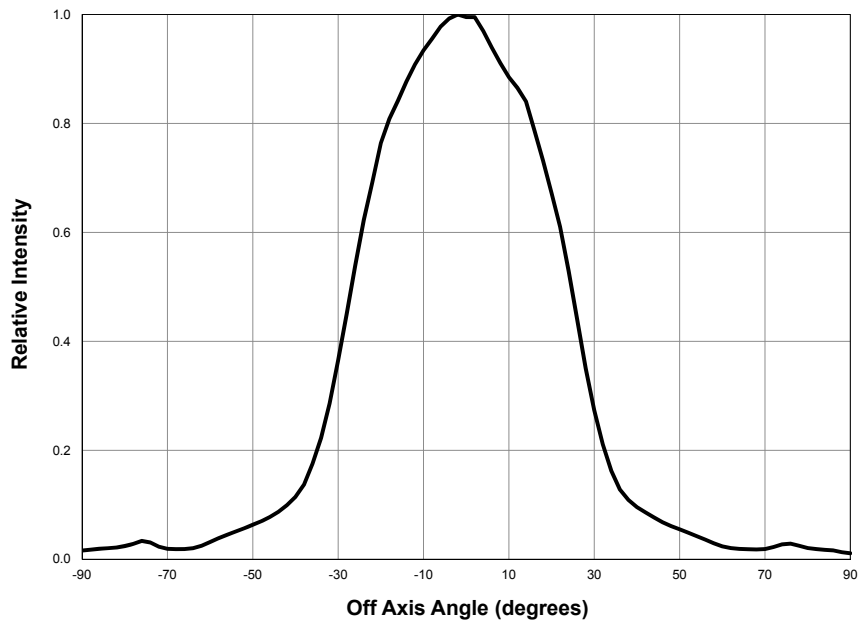

Figure 7d. HPWT-Dxxx relative luminous intensity vs. off axis angle.

Recommended Soldering Conditions for Pb-Free SuperFlux

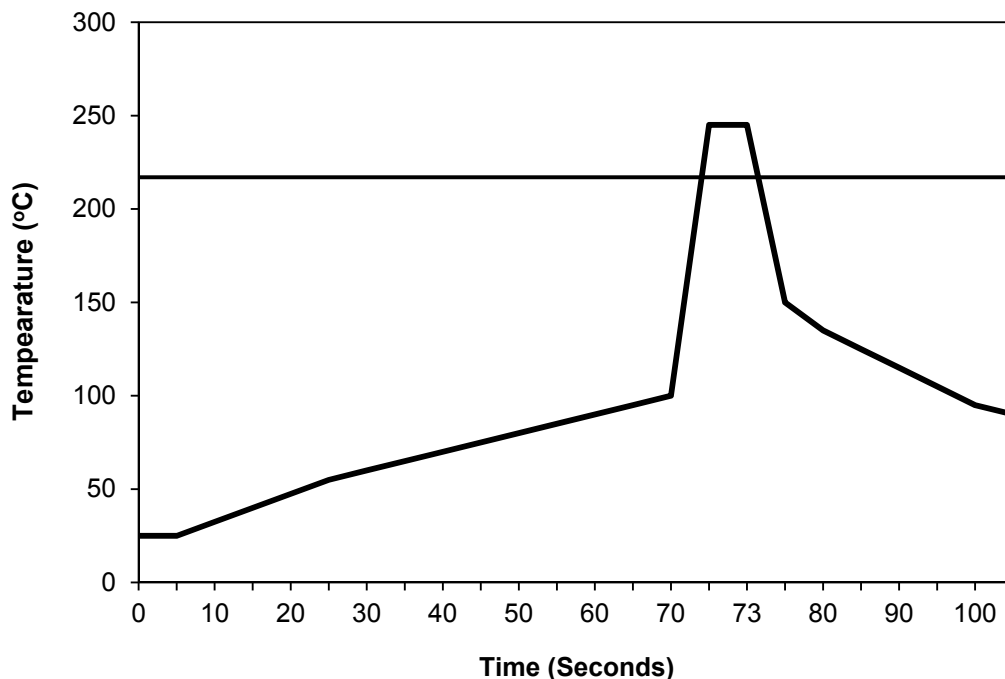

Figure 8. Recommended solder profile.

Table 5. Solder Conditions

Preheat Temperature (°C)	100 +/- 10°C
Preheat Time (s)	70 +/- 20s
Peak Profile Temperature (°C)	245 +/- 5°C
Solder Time Above 217°C	2.5 +/- 0.5s

Notes:

1. All top preheat stages are to be turned off so that the LED body is not directly exposed to the heat source.
2. Profile taken on the LED lead at the bottom of the PCB.
3. Single wave soldering is recommended.
4. Soldering at the lowest possible peak profile temperature and shortest solder time above 217°C are preferable to the LED.
5. The pre-heat temperature ramping rate shall not more than 3°C per second.
6. Do not apply any stress on LED and perform LED lead cutting when the package still not return to room temperature.
7. After soldering, the LED must be protected from mechanical shock and vibration until LED return to room temperature.
8. Solder rework on LED should be avoided.

Product Binning and Labeling

Table 6. Luminous Flux bins for Red, Red-Orange and Amber @ 70 mA

Bin Code	Minimum Luminous Flux Bin	Maximum Luminous Flux Bin
C	1.5	2.4
D	2.0	3.0
E	2.5	3.6
F	3.0	4.2
G	3.5	4.8
H	4.0	6.1
J	5.0	7.3
L	6.0	9.7
M	8.0	12.0
N	10.0	16.0

Note for Table 6:

1. Total Luminous Flux as measured with an integrating sphere after the device has stabilized. $T_j \sim 60^\circ\text{C}$.

Table 7. Dominant Wavelength Bins

LED Color	Bin Code	Minimum Dominant Wavelength (nm)	Maximum Dominant Wavelength (nm)
Red	0	622	645
Red-Orange	1	611	617
	2	615	621
	3	619	629
Amber	1	587	591
	2	589	594
	9	592	595
	3	592	597

Table 8. Forward Voltage Bins, Red, Red-Orange and Amber @ 70 mA

Bin Code	Min Voltage (V)	Max Voltage (V)
1	2.19	2.43
2	2.31	2.55
3	2.43	2.67
4	2.55	2.79
5	2.67	2.91
6	2.79	3.03
7	2.91	3.15

Part Number Selection

Red Part Number Selection

Table 9.

LED Color	Part Number	Viewing Angle (degrees) $2\theta^{1/2}$	Min Flux ⁽¹⁾ $\Phi_v(\text{lm})$	Max Flux ⁽¹⁾ $\Phi_v(\text{lm})$	Minimum Intensity (cd)	Maximum Intensity (cd)
Red	HPWT-RD02-00000	25 X 68	1.5		1.9	
	HPWT-RD02-D4000	25 X 68	2.0	4.8	2.5	6.0
	HPWT-RD02-E4000	25 X 68	2.5	6.1	3.1	7.6
	HPWT-RD02-F4000	25 X 68	3.0	7.3	3.8	9.1
	HPWT-BD02-00000	30	1.5		3.0	
	HPWT-BD02-D4000	30	2.0	4.8	4.0	9.6
	HPWT-BD02-E4000	30	2.5	6.1	5.0	12.2
	HPWT-BD02-F4000	30	3.0	7.3	6.0	14.6
	HPWT-DD02-00000	40	1.5		2.3	
	HPWT-DD02-D4000	40	2.0	4.8	3.0	7.2
	HPWT-DD02-E4000	40	2.5	6.1	3.8	9.2
	HPWT-DD02-F4000	40	3.0	7.3	4.5	11.0
	HPWT-MD02-00000	70	1.5		0.9	
	HPWT-MD02-D4000	70	2.0	4.8	1.2	2.9
	HPWT-MD02-E4000	70	2.5	6.1	1.5	3.7
	HPWT-MD02-F4000	70	3.0	7.3	1.8	4.4

Notes for Table 9:

- Φ_v is the total luminous flux output as measured with an integrating sphere after the device has stabilized.

Part Number Selection

Red-Orange Part Number Selection

Table 10.

LED Color	Part Number	Viewing Angle (degrees) $2\theta^{1/2}$	Min Flux ⁽¹⁾ $\Phi_v(\text{lm})$	Max Flux ⁽¹⁾ $\Phi_v(\text{lm})$	Minimum Intensity (cd)	Maximum Intensity (cd)
Red-Orange	HPWT-RH02-00000	25 X 68	1.5		1.9	
	HPWT-RH02-D4000	25 X 68	2.0	4.8	2.5	6.0
	HPWT-RH02-E4000	25 X 68	2.5	6.1	3.1	7.6
	HPWT-RH02-F4000	25 X 68	3.0	7.3	3.8	9.1
	HPWT-RH02-G4000	25 X 68	3.5	9.7	4.4	12.1
	HPWT-RH02-H4000	25 X 68	4.0	12.0	5.0	15.0
	HPWT-BH02-00000	30	1.5		3.0	12.2
	HPWT-BH02-D4000	30	2.0	4.8	4.0	9.6
	HPWT-BH02-E4000	30	2.5	6.1	5.0	12.2
	HPWT-BH02-F4000	30	3.0	7.3	6.0	14.6
	HPWT-BH02-G4000	30	3.5	9.7	7.0	19.4
	HPWT-BH02-H4000	30	4.0	12.0	8.0	24.0
	HPWT-DH02-00000	40	1.5		2.3	
	HPWT-DH02-D4000	40	2.0	4.8	3.0	7.2
	HPWT-DH02-E4000	40	2.5	6.1	3.8	9.2
	HPWT-DH02-F4000	40	3.0	7.3	4.5	11.0
	HPWT-DH02-G4000	40	3.5	9.7	5.3	14.6
	HPWT-DH02-H4000	40	4.0	12.0	6.0	18.0
	HPWT-MH02-00000	70	1.5		0.9	9.2
	HPWT-MH02-D4000	70	2.0	4.8	1.2	2.9
HPWT-MH02-E4000	70	2.5	6.1	1.5	3.7	
HPWT-MH02-F4000	70	3.0	7.3	1.8	4.4	
HPWT-MH02-G4000	70	3.5	9.7	2.1	5.8	
HPWT-MH02-H4000	70	4.0	12.0	2.4	7.2	

Part Number Selection

Amber Part Number Selection

Table 11.

LED Color	Part Number	Viewing Angle (degrees) $2\theta^{1/2}$	Min Flux ⁽¹⁾ $\Phi_v(\text{lm})$	Max Flux ⁽¹⁾ $\Phi_v(\text{lm})$	Minimum Intensity (cd)	Maximum Intensity (cd)
Amber	HPWT-RL02-00000	25 X 68	1.0		1.3	
	HPWT-RL02-C4000	25 X 68	1.5	4.2	1.9	5.3
	HPWT-RL02-D4000	25 X 68	2.0	4.8	2.5	6.0
	HPWT-BL02-00000	30	1.0		2.0	
	HPWT-BL02-C4000	30	1.5	4.2	3.0	8.4
	HPWT-BL02-D4000	30	2.0	4.8	4.0	9.6
	HPWT-DL02-00000	40	1.0		1.5	12.2
	HPWT-DL02-C4000	40	1.5	4.2	2.3	6.3
	HPWT-DL02-D4000	40	2.0	4.8	3.0	7.2
	HPWT-ML02-00000	70	1.0		0.6	
	HPWT-ML02-C4000	70	1.5	4.2	0.9	2.5
	HPWT-ML02-D4000	70	2.0	4.8	1.2	2.9

Who We Are

Philips Lumileds focuses on one goal: Creating the world's highest performing LEDs. The company pioneered the use of solid-state lighting in breakthrough products such as the first LED backlit TV, the first LED flash in camera phones, and the first LED daytime running lights for cars. Today we offer the most comprehensive portfolio of high quality LEDs and uncompromising service.

Philips Lumileds brings LED's qualities of energy efficiency, digital control and long life to spotlights, downlights, high bay and low bay lighting, indoor area lighting, architectural and specialty lighting as well as retrofit lamps. Our products are engineered for optimal light quality and unprecedented efficacy at the lowest overall cost. By offering LEDs in chip, packaged and module form, we deliver supply chain flexibility to the inventors of next generation illumination.

Philips Lumileds understands that solid state lighting is not just about energy efficiency. It is about elegant design. Reinventing form. Engineering new materials. Pioneering markets and simplifying the supply chain. It's about a shared vision. Learn more about our comprehensive portfolio of LEDs at www.philipslumileds.com.

Philips Lumileds Lighting Company shall not be liable for any kind of loss of data or any other damages, direct, indirect or consequential, resulting from the use of the provided information and data. Although Philips Lumileds Lighting Company has attempted to provide the most accurate information and data, the materials and services information and data are provided "as is" and Philips Lumileds Lighting Company neither warranties, nor guarantees the contents and correctness of the provided information and data. Philips Lumileds Lighting Company reserves the right to make changes without notice. You as user agree to this disclaimer and user agreement with the download or use of the provided materials, information and data.



©2014 Philips Lumileds Lighting Company. All rights reserved.
LUXEON is a registered trademark of the Philips Lumileds Lighting Company in the United States and other countries.

www.philipslumileds.com
www.philipslumileds.cn.com