



Typical Applications

The HMC634LC4 is ideal for:

- Point-to-Point Radios
- Point-to-Multi-Point Radios & VSAT
- LO Driver for Mixers
- Military & Space

Features

- Gain: 21 dB
- P1dB: +22 dBm
- Saturated Power: +23 dBm @ 17% PAE
- Single Supply Voltage: +5V @180 mA
- 50 Ohm Matched Input/Output
- 24 Lead 4x4mm SMT Package: 16mm²

Functional Diagram

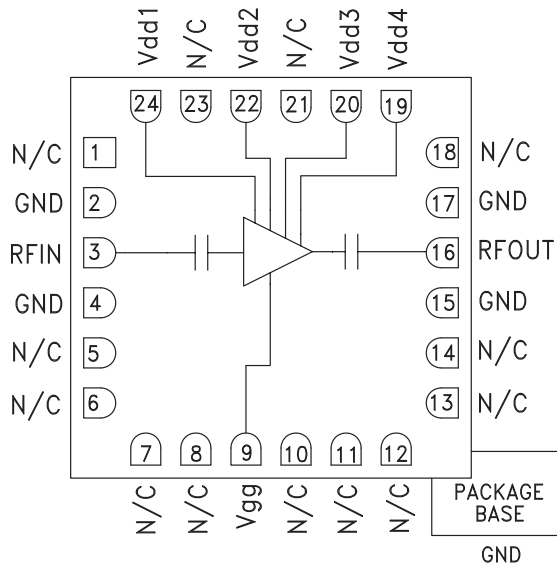

General Description

The HMC634LC4 is a GaAs PHEMT MMIC Driver Amplifier in a leadless 4 x 4 mm ceramic surface mount package which operates between 5 and 20 GHz. The amplifier provides up to 21 dB of gain, +29 dBm Output IP3, and +22 dBm of output power at 1 dB gain compression, while requiring 180 mA from a +5V supply. The HMC634LC4 is an ideal driver amplifier for microwave radio applications from 5 to 20 GHz, and may be biased at +5V, 130 mA to provide lower gain with optimized PAE. The amplifier's I/Os are DC blocked and matched to 50 Ohms with no external matching required.

Electrical Specifications, $T_A = +25^\circ\text{C}$, $V_{dd_{1-4}} = 5\text{V}$, $I_{dd} = 180\text{ mA}$ [1]

Parameter	Min.	Typ.	Max.	Min.	Typ.	Max.	Units
Frequency Range	5 - 16		16 - 20				GHz
Gain	18	21		17	20		dB
Gain Variation Over Temperature		0.025	0.035		0.020	0.030	dB/°C
Input Return Loss		18			14		dB
Output Return Loss		14			13		dB
Output Power for 1 dB Compression (P1dB)	19	22		16	20		dBm
Saturated Output Power (Psat)		23			20.5		dBm
Output Third Order Intercept (IP3)		29			28		dBm
Noise Figure		7.5			7.5		dB
Supply Current (Idd) (Idd = Idd ₁ + Idd ₂ + Idd ₃ + Idd ₄)		180			180		mA

[1] Adjust Vgg between -2 to 0V to achieve Idd= 180 mA Typical.



GaAs PHEMT MMIC DRIVER AMPLIFIER, 5 - 20 GHz

Broadband Gain & Return Loss

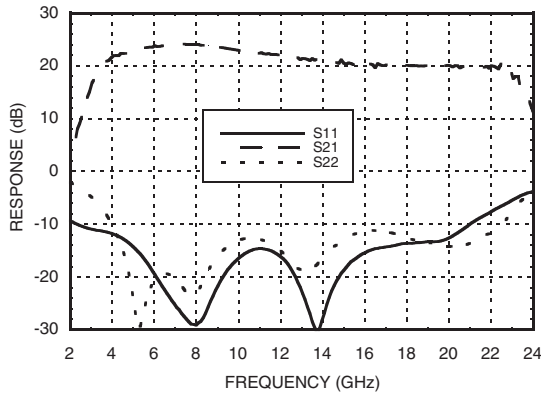

Gain vs. Temperature

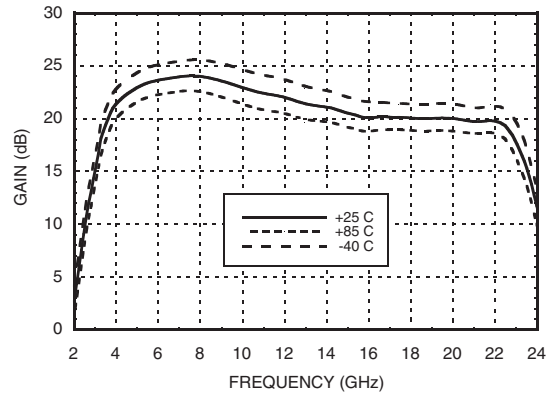

Input Return Loss vs. Temperature

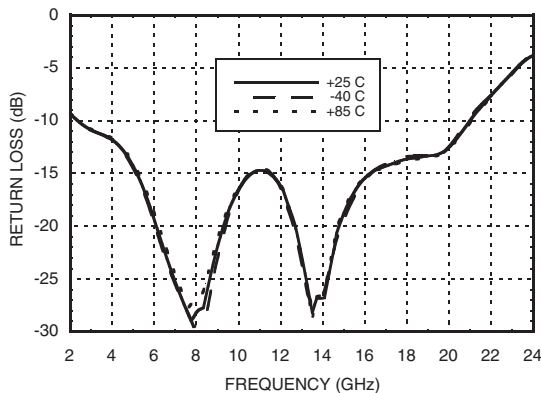

Output Return Loss vs. Temperature

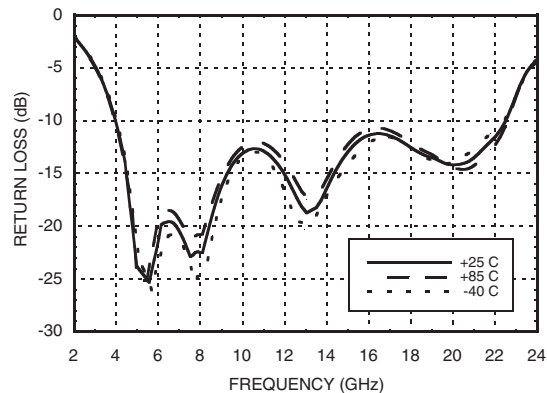

P1dB vs. Temperature

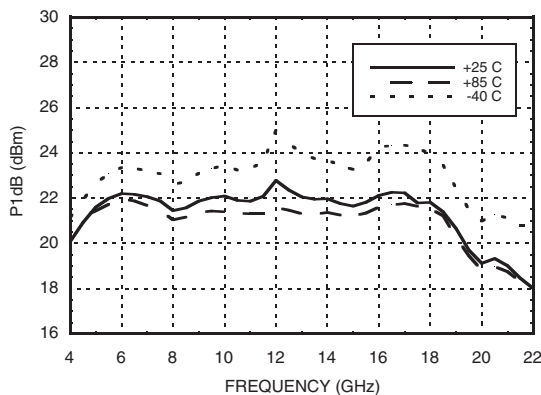

Psat vs. Temperature

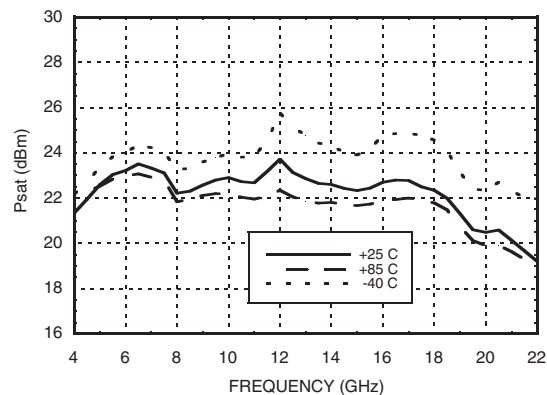



GaAs PHEMT MMIC DRIVER AMPLIFIER, 5 - 20 GHz

Power Compression @ 12.5 GHz

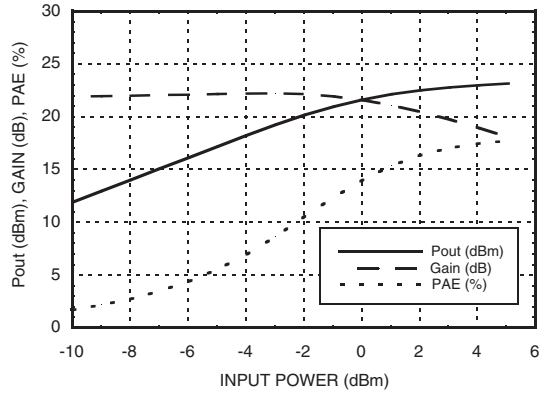

Power Compression @ 20 GHz

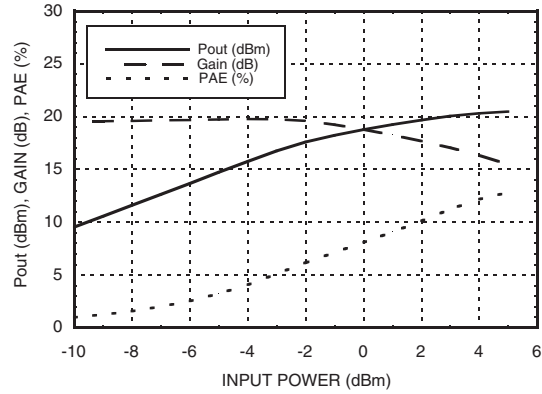

Output IP3 vs. Temperature

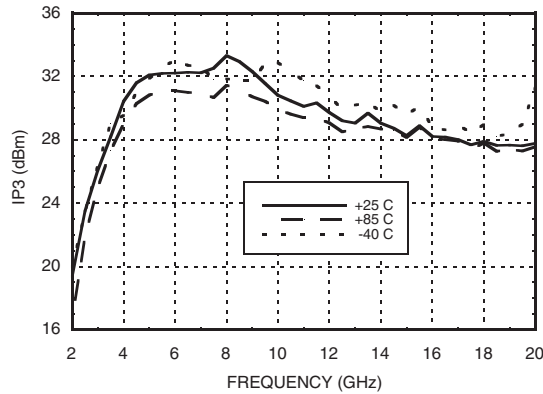

Noise Figure vs. Temperature

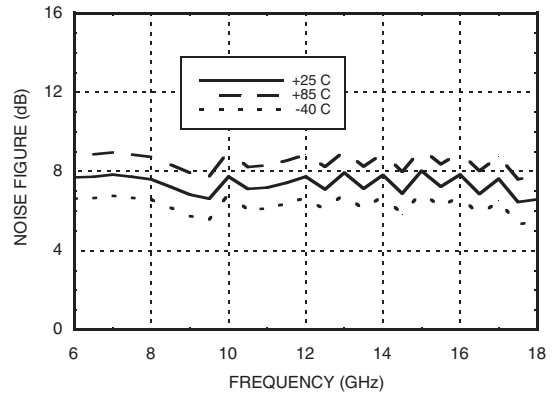

Gain & Power vs. Supply Voltage @ 12.5 GHz

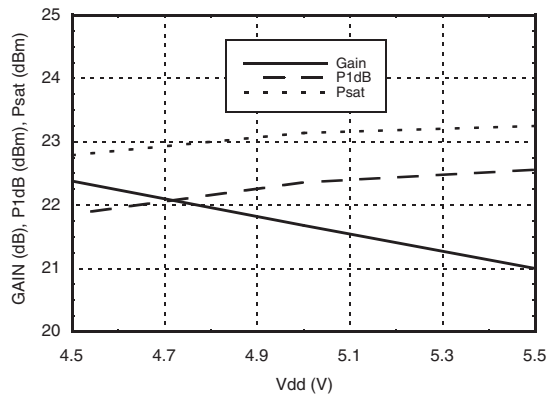

Reverse Isolation vs. Temperature

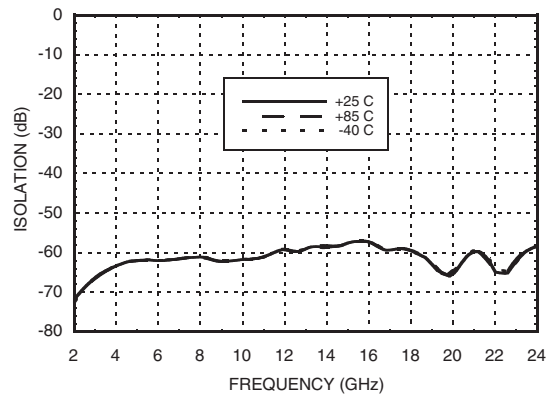



GaAs PHEMT MMIC DRIVER AMPLIFIER, 5 - 20 GHz

Gain, Power & Output IP3 vs. Gate Voltage @ 12.5 GHz

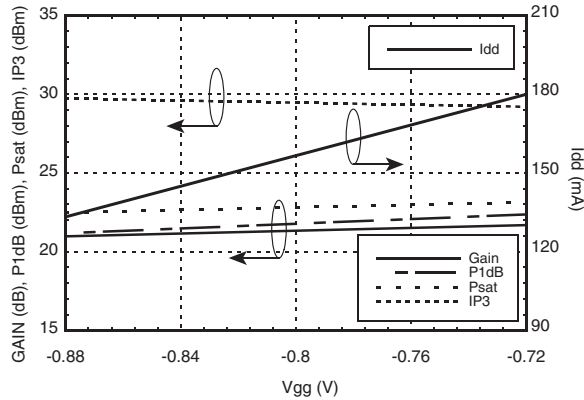

Absolute Maximum Ratings

Drain Bias Voltage (Vdd1, Vdd2, Vdd3, Vdd4)	+5.5 Vdc
Gate Bias Voltage (Vgg)	-3 to 0 Vdc
RF Input Power (RFIN)(Vdd = +5 Vdc)	+10 dBm
Channel Temperature	175 °C
Continuous P _{diss} (T= 85 °C) (derate 11.17 mW/°C above 85 °C)	1 W
Thermal Resistance (channel to package bottom)	89.46 °C/W
Storage Temperature	-65 to +150 °C
Operating Temperature	-40 to +85 °C

Typical Supply Current vs. Vdd

Vdd (V)	I _{dd} (mA)
4.5	177
5.0	180
5.5	183

Note: Amplifier will operate over full voltage ranges shown above



ELECTROSTATIC SENSITIVE DEVICE
OBSERVE HANDLING PRECAUTIONS

Outline Drawing

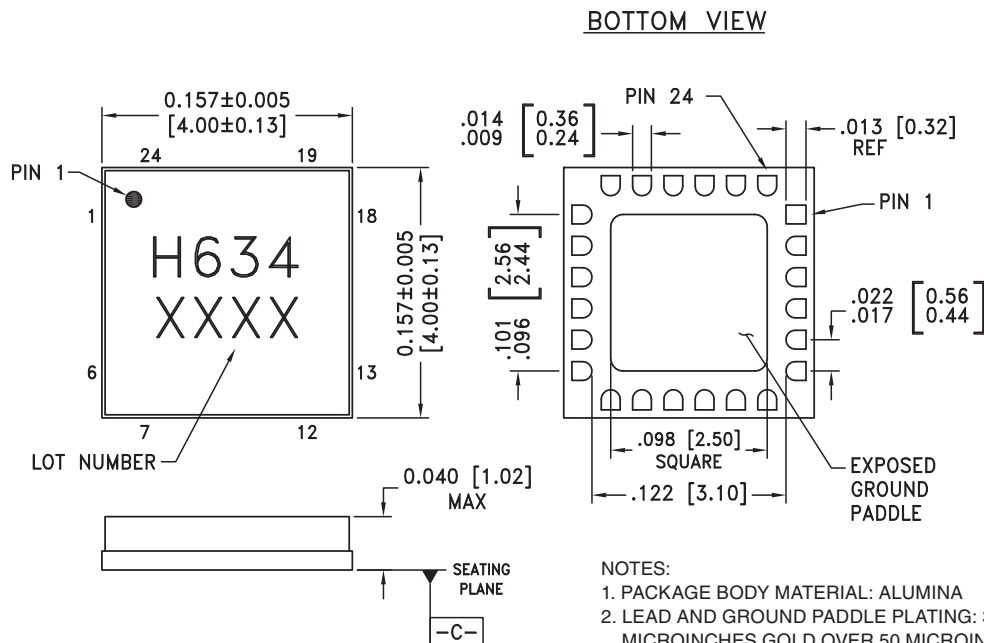

NOTES:

1. PACKAGE BODY MATERIAL: ALUMINA
2. LEAD AND GROUND PADDLE PLATING: 30-80 MICROINCHES GOLD OVER 50 MICROINCHES MINIMUM NICKEL.
3. DIMENSIONS ARE IN INCHES [MILLIMETERS].
4. LEAD SPACING TOLERANCE IS NON-CUMULATIVE.
5. PACKAGE WARP SHALL NOT EXCEED 0.05mm DATUM -C-
6. ALL GROUND LEADS AND GROUND PADDLE MUST BE SOLDERED TO PCB RF GROUND.

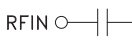
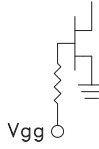
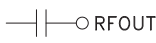
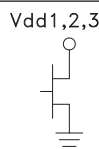

Pin Descriptions

Pin Number	Function	Description	Interface Schematic
1, 5 - 8, 10 - 14, 18, 21, 23	N/C	The pins are not connected internally; however, all data shown herein was measured with these pins connected to RF/DC ground externally.	
2, 4, 15, 17	GND	Package Bottom must be connected to RF/DC ground.	
3	RFIN	This pin is AC coupled and matched to 50 Ohms.	
9	Vgg	Gate control for amplifier, please follow "MMIC Amplifier Biasing Procedure" Application Note: See application circuit for required external components.	
16	RFOUT	This pin is AC coupled and matched to 50 Ohms.	
24, 22, 20, 19	Vdd1, Vdd2, Vdd3, Vdd4	Power Supply Voltage for the amplifier. See application circuit for required external components.	

Application Circuit

Component	Value
C1 - C5	100 pF
C6 - C10	1000 pF
C11 - C15	2.2 μF

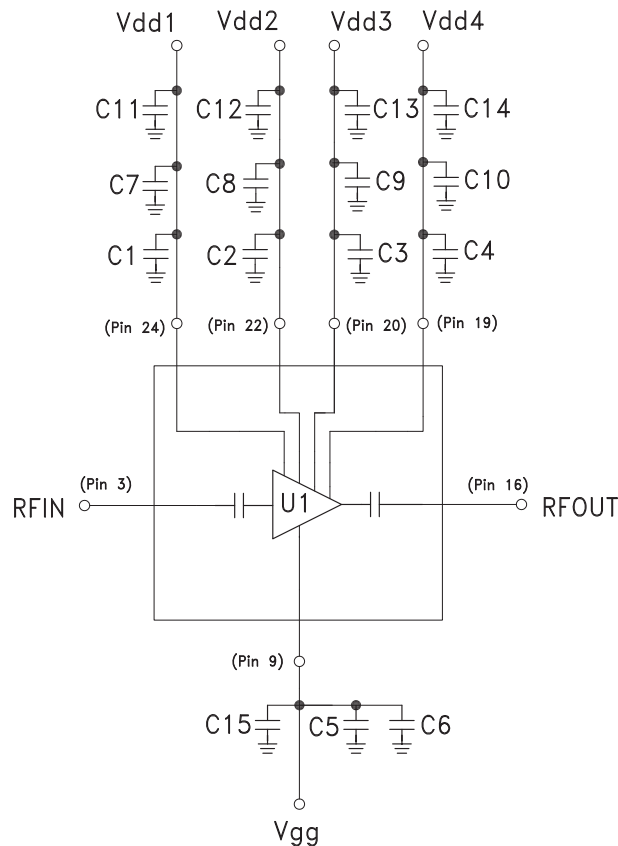

Evaluation PCB

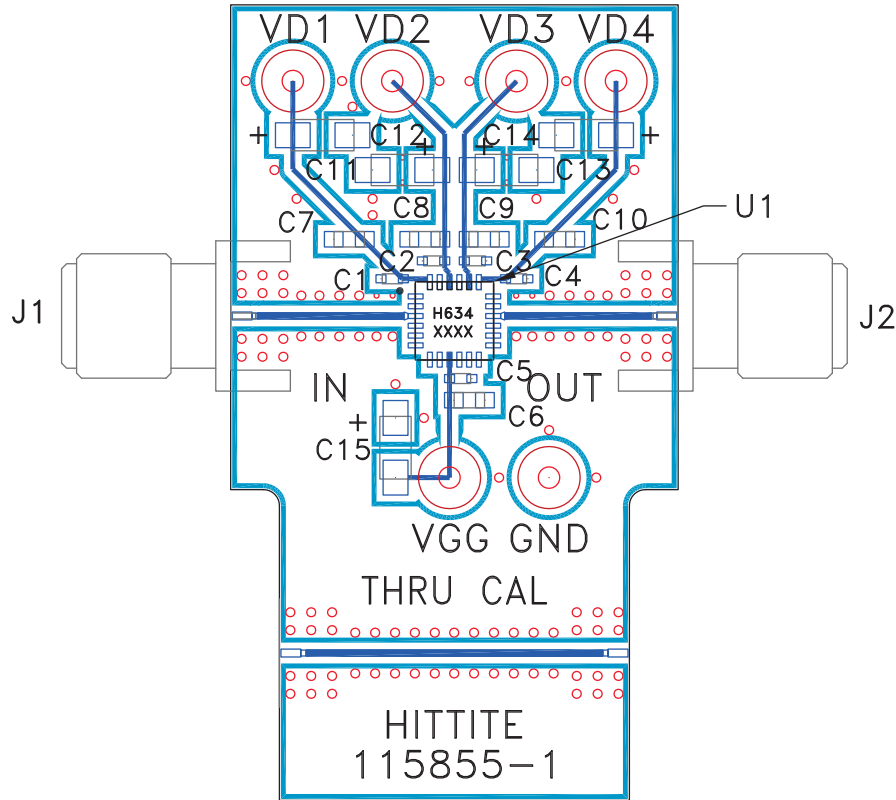

List of Materials for Evaluation PCB 115857 [1]

Item	Description
J1 - J2	2.92 mm PC Mount K-Connector
VD1 - VD4	DC Pin
C1 - C5	100 pF Capacitor, 0402 Pkg.
C6 - C10	1000 pF Capacitor, 0603 Pkg.
C11 - C15	2.2 μ F Capacitor, Tantalum
U1	HMC634LC4 Driver Amplifier
PCB [2]	115855 Evaluation PCB

[1] Reference this number when ordering complete evaluation PCB

[2] Circuit Board Material: Rogers 4350

The circuit board used in the final application should use RF circuit design techniques. Signal lines should have 50 ohm impedance while the package ground leads and exposed paddle should be connected directly to the ground plane similar to that shown. A sufficient number of via holes should be used to connect the top and bottom ground planes. The evaluation board should be mounted to an appropriate heat sink. The evaluation circuit board shown is available from Hittite upon request.