

HEI Series



Power inductor takes an important part in the efficiency performance of DC/DC converter, and HEI products is designed to take care of both PFM and PWM application performance. Therefore, for HEI product, the Q(Rac) value at light load and the RDC value at heavy load are both superior to other competitors. Furthermore, the saturated current performance is also great, so it helps to get the ripple current lower and enhance the efficiency result.

Features

- High Efficiency
- Small Sizes in 2.0*1.2*0.8mm
- High Saturated Current
- High Q / Low Rac
- Low Rdc

Applications

- Smart phones
- Bluetooth Headsets
- Tablet PCs
- PND
- PC peripheral devices
- DSC, Camcorders

Product Identification

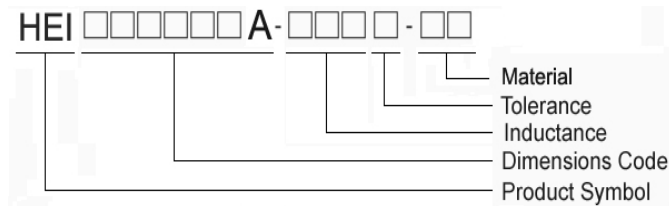

Shape and Dimensions

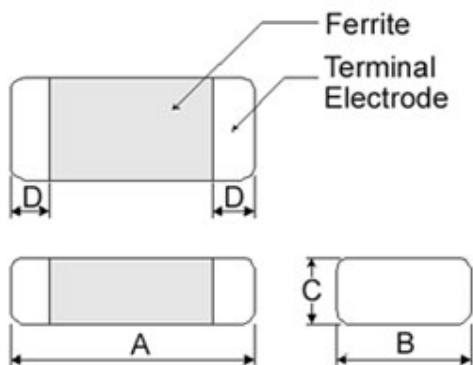

Dimensions in mm

TYPE	A	B	C	D
201208A	2.0±0.2	1.25±0.2	0.8Max	0.5±0.3
201210A	2.0±0.2	1.25±0.2	1.0Max	0.5±0.3
201610A	2.0±0.2	1.60±0.2	1.0Max	0.5±0.3
252010A	2.5±0.3	2.00±0.3	1.0Max	0.6±0.3
252012A	2.5±0.3	2.00±0.3	1.2Max	0.6±0.3
322510A	3.2±0.3	2.50±0.3	1.0Max	0.5±0.3
322512A	3.2±0.3	2.50±0.3	1.2Max	0.5±0.3

Recommended Pattern

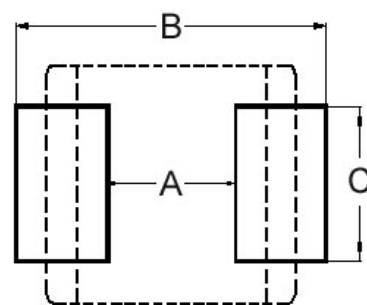

Dimensions in mm

TYPE	A	B	C
201208A	0.8~1.2	2.3~2.9	1.0~1.4
201210A	0.8~1.2	2.3~2.9	1.0~1.4
201610A	0.9	2.0	1.6
252010A	1.2	2.8	2.0
252012A	1.2	2.8	2.0
322510A	1.7	3.2	2.5
322512A	1.7	3.2	2.5

Electrical Characteristics

Part Number	Inductance	Tolerance	Test Frequency	I _{rms} (A)	I _{sat} (A)	RDC(mΩ)
	(μH)	(±%)	(MHz)	Max(Typ)	Max(Typ)	Max(Typ)
HEI201208A-R24M-Q8	0.24	20	2	4.2(4.8)	4.8(5.4)	25(19)
HEI201208A-R47M-Q8	0.47	20	2	3.0(3.4)	3.2(3.6)	48(40)

- I_{rms} DC current (A) that will cause an approximate ΔT of 40°C.
- I_{sat} DC current (A) that will cause L to drop approximately 30%
- Tolerance : M = ±20%
- L : Agilent E4991/HP4287A+16197A, 2MHz 0.2V
- R_{dc} : CHEN HWA502
- I_{sat} : Agilent E4980A+HP42841A
- I_{rms} : Agilent 6641 SYSTEM DC POWER SUPPLY
- Operating temperature range from -40°C to 125°C. (Including self - temperature rise)

Test Instruments : E4991A Impedance / Material Analyzer

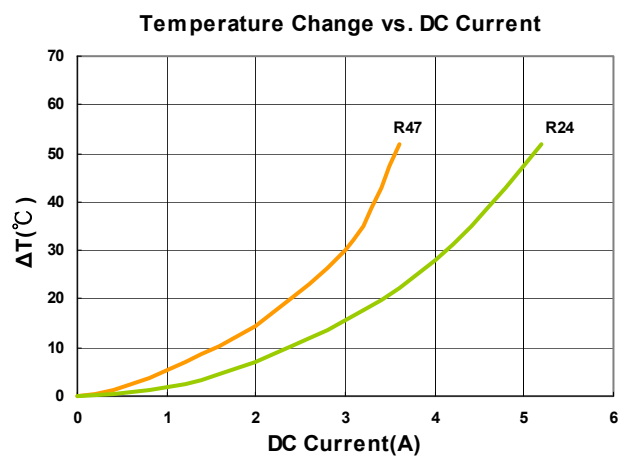
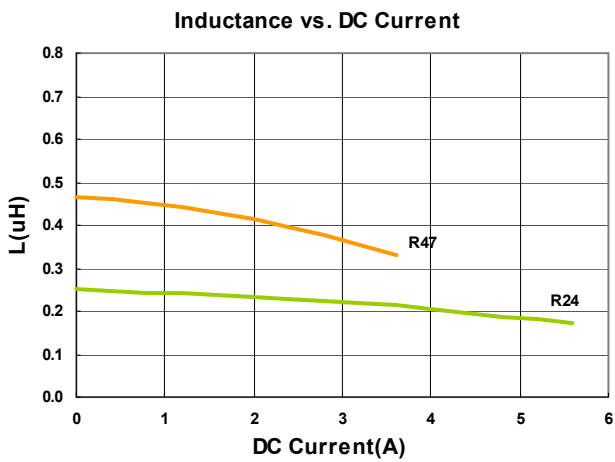

Electrical Characteristics

Part Number	Inductance	Tolerance	Test Frequency	Irms(A)	Isat(A)	RDC(mΩ)
	(uH)	(±%)	(MHz)	Max(Typ)	Max(Typ)	Max(Typ)
HEI201210A-R24M-Q8	0.24	20	2	3.7(4.6)	4.5(5.7)	28(22)
HEI201210A-R47M-Q8	0.47	20	2	3.0(3.7)	3.3(4.2)	42(33)
HEI201210A-1R0M-Q8	1.0	20	2	2.2(2.7)	2.3(2.8)	78(69)
HEI201210A-1R5M-Q8	1.5	20	2	1.8(2.2)	1.9(2.3)	112(94)
HEI201210A-2R2M-Q8	2.2	20	2	1.5(1.8)	1.6(2.0)	168(153)

- **Irms** DC current (A) that will cause an approximate ΔT of 40°C.
- **Isat** DC current (A) that will cause L to drop approximately 30%
- Tolerance : M = ±20%
- L : Agilent E4991/HP4287A+16197A, 2MHz 0.2V
- Rdc : CHEN HWA502
- Isat : Agilent E4980A+HP42841A
- Irms : Agilent 6641 SYSTEM DC POWER SUPPLY
- Operating temperature range from -40°C to 125°C. (Including self - temperature rise)

Test Instruments : E4991A Impedance / Material Analyzer

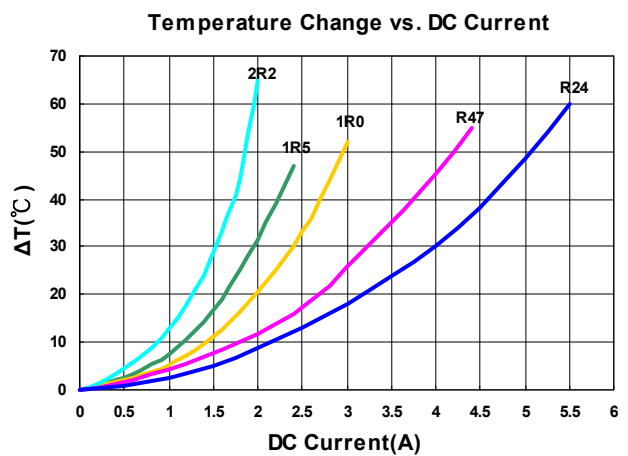
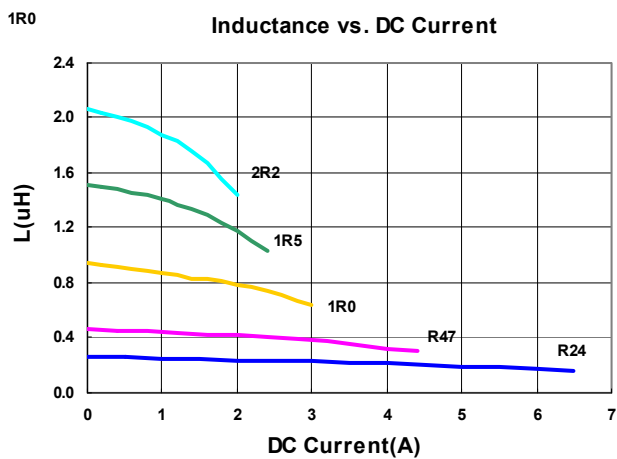

Electrical Characteristics

Part Number	Inductance	Tolerance	Test Frequency	Irms(A)	Isat(A)	RDC(mΩ)
	(uH)	(±%)	(MHz)	Max(Typ)	Max(Typ)	Max(Typ)
HEI201610A-R24M-Q8	0.24	20	2	3.9(4.8)	5.6(7.0)	27(21)
HEI201610A-R47M-Q8	0.47	20	2	3.5(4.2)	3.9(4.8)	42(33)
HEI201610A-R68M-Q8	0.68	20	2	2.7(3.4)	3.2(4.0)	56(43)
HEI201610A-1R0M-Q8	1.0	20	2	2.5(3.1)	2.9(3.6)	65(53)
HEI201610A-1R5M-Q8	1.5	20	2	2.3(2.7)	2.5(2.8)	85(75)
HEI201610A-2R2M-Q8	2.2	20	2	1.8(2.2)	2.4(2.7)	135(112)

- **Irms** DC current (A) that will cause an approximate ΔT of 40°C.
- **Isat** DC current (A) that will cause L to drop approximately 30%
- Tolerance : M = ±20%
- L : Agilent E4991/HP4287A+16197A, 2MHz 0.2V
- Rdc : CHEN HWA502
- Isat : Agilent E4980A+HP42841A
- Irms : Agilent 6641 SYSTEM DC POWER SUPPLY
- Operating temperature range from -40°C to 125°C. (Including self - temperature rise)

Test Instruments : E4991A Impedance / Material Analyzer

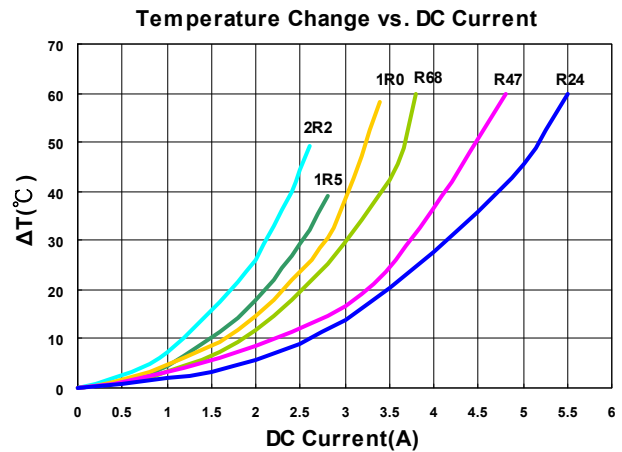
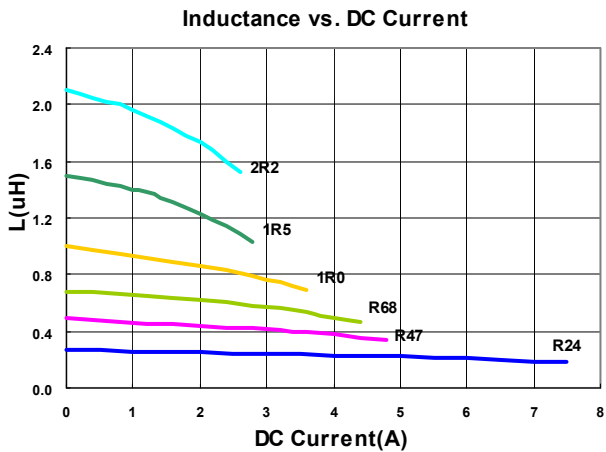

Electrical Characteristics

Part Number	Inductance	Tolerance	Test Frequency	Irms(A)	Isat(A)	RDC(mΩ)
	(uH)	(±%)	(MHz)	Max(Typ)	Max(Typ)	Max(Typ)
HEI252010A-R24M-Q8	0.24	20	2	5.5(6.5)	8.0(9.5)	18(13)
HEI252010A-R33M-Q8	0.33	20	2	4.8(5.5)	6.5(8.0)	24(18)
HEI252010A-R47M-Q8	0.47	20	2	3.9(4.5)	5.0(6.2)	35(27)
HEI252010A-R68M-Q8	0.68	20	2	3.7(4.2)	4.5(5.6)	40(32)
HEI252010A-1R0M-Q8	1.0	20	2	3.0(3.5)	3.7(4.6)	53(45)
HEI252010A-1R5M-Q8	1.5	20	2	2.4(2.8)	3.1(3.8)	75(68)
HEI252010A-2R2M-Q8	2.2	20	2	2.2(2.5)	2.5(3.0)	97(87)

- Irms DC current (A) that will cause an approximate ΔT of 40°C.
- Isat DC current (A) that will cause L to drop approximately 30%
- Tolerance : M = ±20%
- L : Agilent E4991/HP4287A+16197A, 2MHz 0.2V
- Rdc : CHEN HWA502
- Isat : Agilent E4980A+HP42841A
- Irms : Agilent 6641 SYSTEM DC POWER SUPPLY
- Operating temperature range from -40°C to 125°C. (Including self - temperature rise)

Test Instruments : E4991A Impedance / Material Analyzer

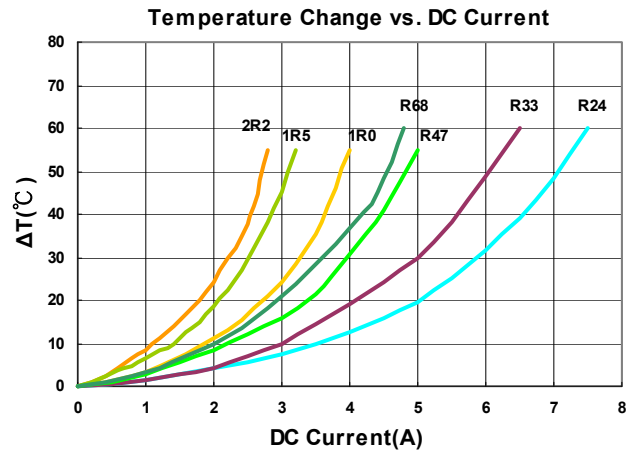
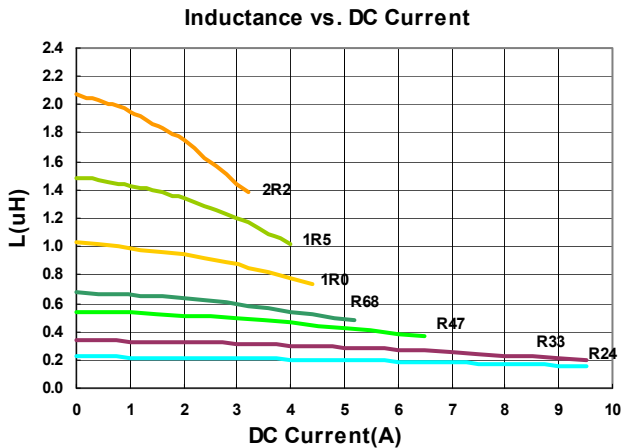

Electrical Characteristics

Part Number	Inductance	Tolerance	Test Frequency	Irms(A)	Isat(A)	RDC(mΩ)
	(uH)	(±%)	(MHz)	Max(Typ)	Max(Typ)	Max(Typ)
HEI252012A-R24M-Q8	0.24	20	2	6.2(7.3)	9.5(12)	15(11.5)
HEI252012A-R47M-Q8	0.47	20	2	3.8(4.5)	5.6(7.0)	33(28)
HEI252012A-R68M-Q8	0.68	20	2	3.8(4.4)	5.0(6.2)	36(30)
HEI252012A-1R0M-Q8	1.0	20	2	3.6(4.1)	4.4(5.5)	42(35)
HEI252012A-1R5M-Q8	1.5	20	2	2.7(3.1)	3.4(4.2)	65(57)
HEI252012A-2R2M-Q8	2.2	20	2	2.5(2.9)	3.0(3.7)	83(74)

- **Irms** DC current (A) that will cause an approximate ΔT of 40°C.
- **Isat** DC current (A) that will cause L to drop approximately 30%
- Tolerance : M = ±20%
- L : Agilent E4991/HP4287A+16197A, 2MHz 0.2V
- Rdc : CHEN HWA502
- Isat : Agilent E4980A+HP42841A
- Irms : Agilent 6641 SYSTEM DC POWER SUPPLY
- Operating temperature range from -40°C to 125°C. (Including self - temperature rise)

Test Instruments : E4991A Impedance / Material Analyzer

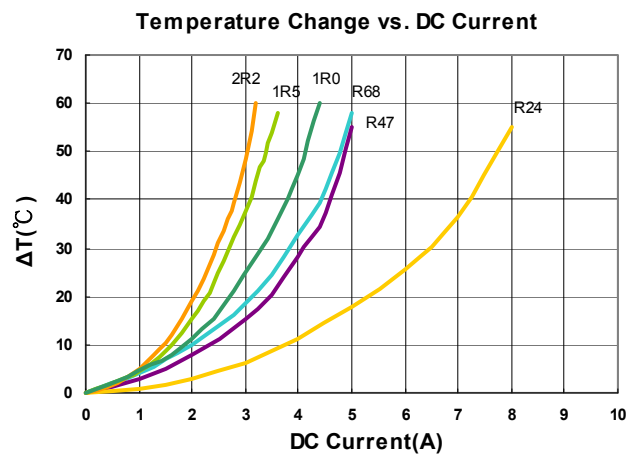
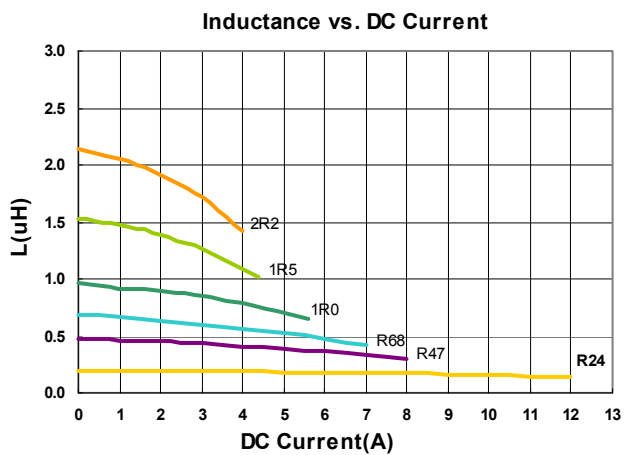

Electrical Characteristics

Part Number	Inductance	Tolerance	Test Frequency	Irms(A)	Isat(A)	RDC(mΩ)
	(uH)	(±%)	(MHz)	Max(Typ)	Max(Typ)	Max(Typ)
HEI322510A-R24M-Q8	0.24	20	2	6.0(6.8)	9.0(11.5)	16(12)
HEI322510A-R33M-Q8	0.33	20	2	5.8(6.5)	8.0(9.5)	17(12.5)
HEI322510A-R47M-Q8	0.47	20	2	4.5(5.4)	6.0(7.3)	24(19)
HEI322510A-1R0M-Q8	1.0	20	2	3.3(3.7)	4.1(4.7)	46(39)
HEI322510A-1R5M-Q8	1.5	20	2	3.2(3.5)	3.5(4.0)	58(50)
HEI322510A-2R2M-Q8	2.2	20	2	2.5(2.8)	3.0(3.5)	85(73)

- **Irms** DC current (A) that will cause an approximate ΔT of 40°C.
- **Isat** DC current (A) that will cause L to drop approximately 30%
- Tolerance : M = ±20%
- L : Agilent E4991/HP4287A+16197A, 2MHz 0.2V
- Rdc : CHEN HWA502
- Isat : Agilent E4980A+HP42841A
- Irms : Agilent 6641 SYSTEM DC POWER SUPPLY
- Operating temperature range from -40°C to 125°C. (Including self - temperature rise)

Test Instruments : E4991A Impedance / Material Analyzer

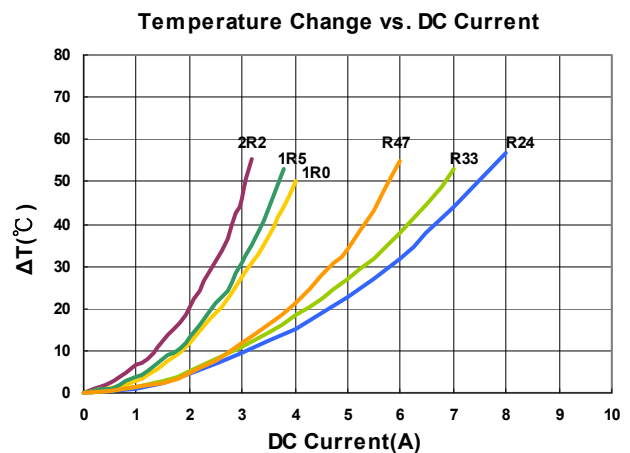
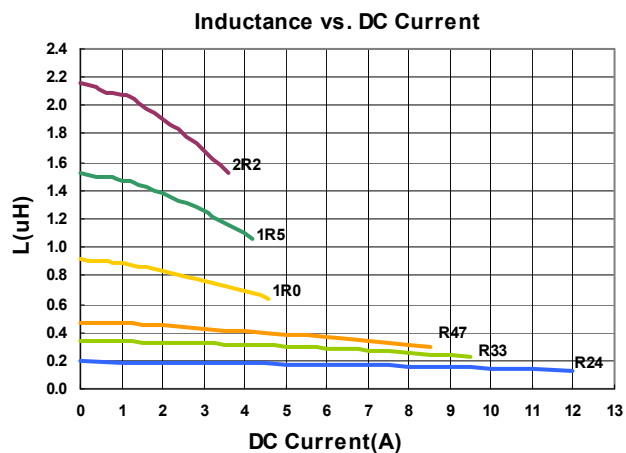

Electrical Characteristics

Part Number	Inductance	Tolerance	Test Frequency	Irms(A)	Isat(A)	RDC(mΩ)
	(uH)	(±%)	(MHz)	Max(Typ)	Max(Typ)	Max(Typ)
HEI322512A-R47M-Q8	0.47	20	2	4.6(5.2)	7.0(8.2)	25(19)
HEI322512A-1R0M-Q8	1.0	20	2	3.7(4.2)	5.7(6.5)	34(27.5)
HEI322512A-1R5M-Q8	1.5	20	2	2.8(3.2)	4.0(4.6)	59(51)
HEI322512A-2R2M-Q8	2.2	20	2	2.7(3.0)	3.5(4.0)	73(64)

- **Irms** DC current (A) that will cause an approximate ΔT of 40°C .
- **Isat** DC current (A) that will cause L to drop approximately 30%
- Tolerance : M = $\pm 20\%$
- L : Agilent E4991/HP4287A+16197A, 2MHz 0.2V
- Rdc : CHEN HWA502
- Isat : Agilent E4980A+HP42841A
- Irms : Agilent 6641 SYSTEM DC POWER SUPPLY
- Operating temperature range from -40°C to 125°C . (Including self - temperature rise)

Test Instruments : E4991A Impedance / Material Analyzer

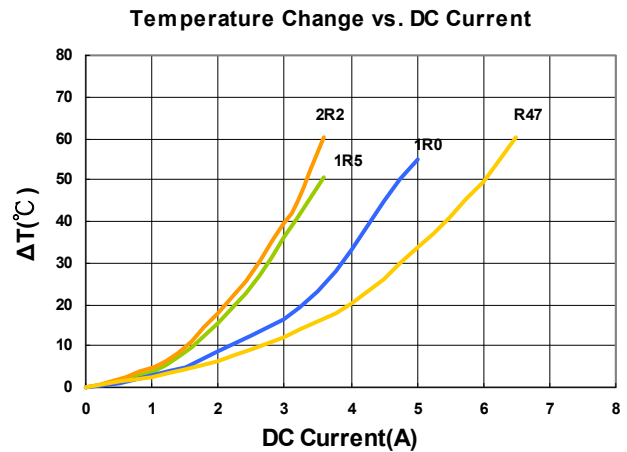
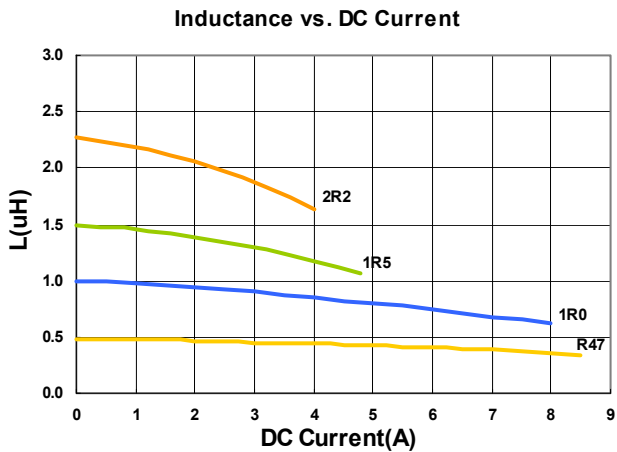

Packaging Specifications

Tape Dimensions

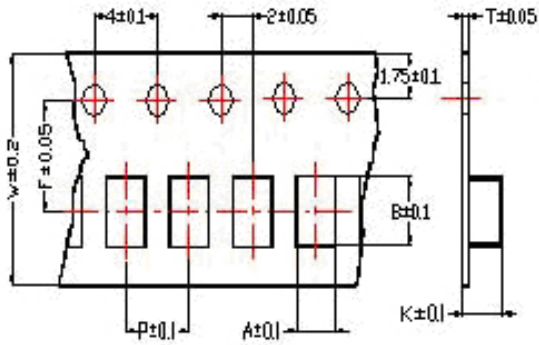

Tape Material

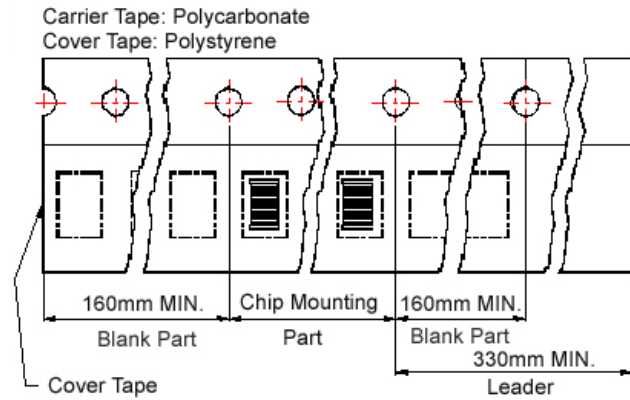

Reel Dimensions

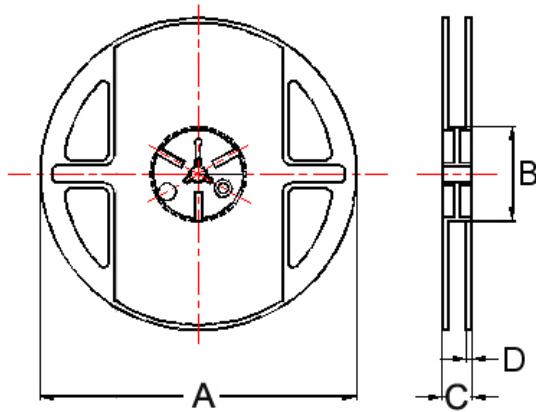

Dimensions in mm

TYPE	Tape Dimensions							Reel Dimensions				Quantity PCS / REEL
	A	B	T	W	P	F	K	A	B	C	D	
201208A	1.45	2.25	0.22	8	4	3.5	1.04	178	60	12	1.5	3000
201210A	1.50	2.25	0.22	8	4	3.5	1.15	178	60	12	1.5	3000
201610A	1.80	2.20	0.22	8	4	3.5	1.15	178	60	12	1.5	3000
252010A	2.25	2.80	0.22	8	4	3.5	1.35	178	60	12	1.5	3000
252012A	2.25	2.80	0.22	8	4	3.5	1.35	178	60	12	1.5	3000
322510A	2.80	3.55	0.23	8	4	3.5	1.20	178	60	12	1.5	3000
322512A	2.80	3.50	0.23	8	4	3.5	1.34	178	60	12	1.5	3000