

CMMI Series For HDMI, USB 3.0

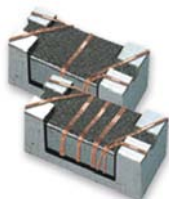

A full series of common mode choke is designed for excellent noise attenuation and compact sizing for use in wide range of applications. Both standard series and custom designs are available.

**Features**

- RoHS Compliant
- Miniature SMD type common mode filter for fully automated assembly
- Excellent solderability

**Applications**

- HDMI
- USB lines (for personal computers and peripheral), DVC, STB, LVDS, panel line for liquid display panels, etc.

**Product Identification**

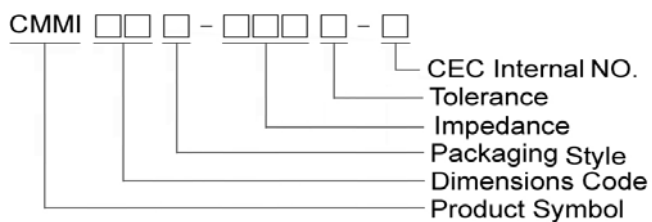

- Packaging: T : Tape and Reel

**Shape and Dimensions**

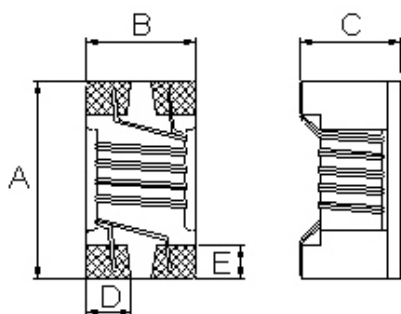

Dimensions in mm

TYPE	A	B	C	D	E
CMMI11	1.25±0.2	1.00±0.2	0.80±0.1	0.32	0.33
CMMI21	2.05±0.2	1.25±0.2	1.20±0.2	0.50	0.58

**Recommended Pattern**

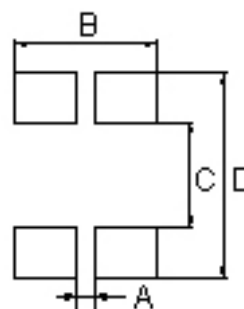

Dimensions in mm

TYPE	A	B	C	D
CMMI11	0.36	1.00	0.59	1.75
CMMI21	0.50	1.20	0.80	2.60

## Electrical Characteristics

Part Number	Impedance (Ω)	Test Frequency (MHz)	Tolerance (±%)	Idc (mA) Max	Rated Voltage (Vdc)	Rdc (Ω) Max	Insulation Resistance (MΩ) Min
CMMI11T-600Y-N	60	100	25	250	20	0.40	10
CMMI11T-900Y-N	90	100	25	250	20	0.30	10

- When ordering, please specify tolerance and packaging codes
- Tolerance : Y = ±25%
- Packaging : Clear tape and reel { standard }
- Z : HP4286A / HP4287A / Agilent E4991A + Agilent16197A
- Rdc(single line) :CH502BC
- Idc : HP4284A+HP42841A/HP4285A+HP42841A
- Insulation Resistance : Agilent HP4339B
- Operating temperature range from -40°C to 105°C . (Including self - temperature rise )

**Test Instruments :** HP4291A Material/Impedance Analyzer

### Typical Impedance vs. Frequency

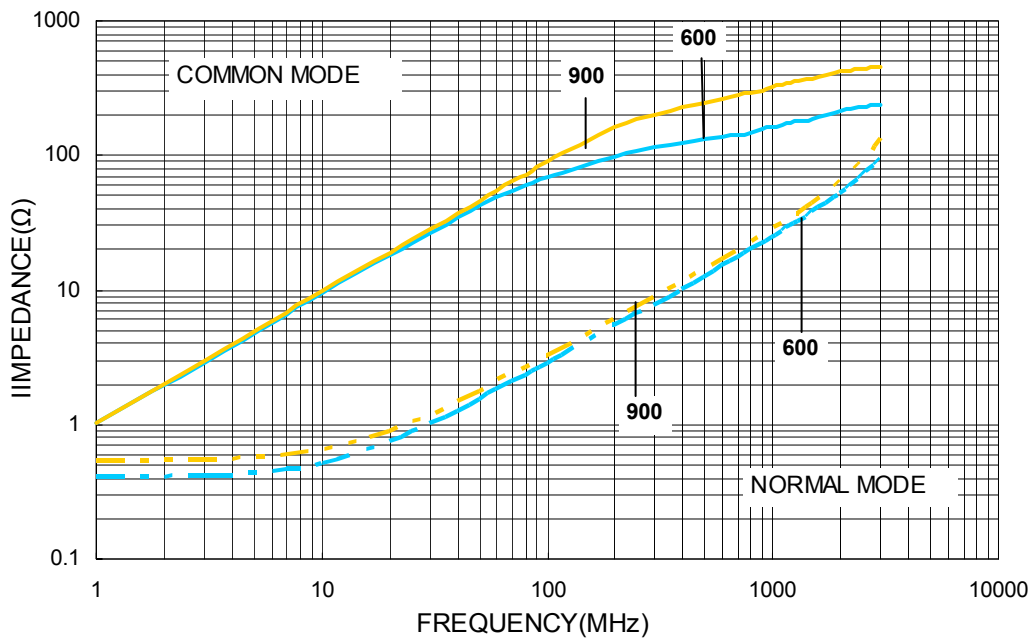

**CMMI11T-600Y-N**

Insertion Loss For HDMI Testing:

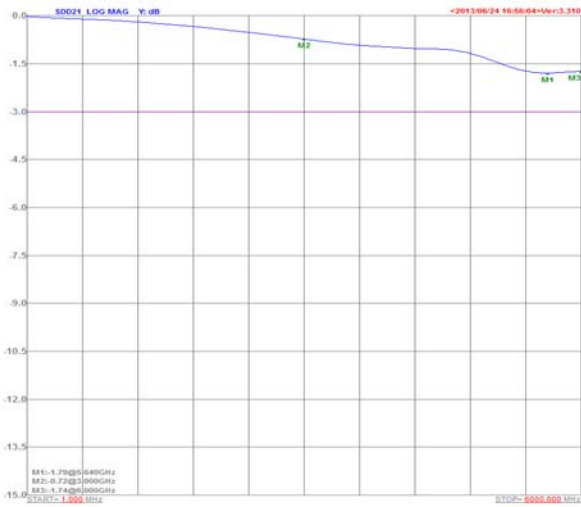

Insertion Loss For USB3.0 Testing:

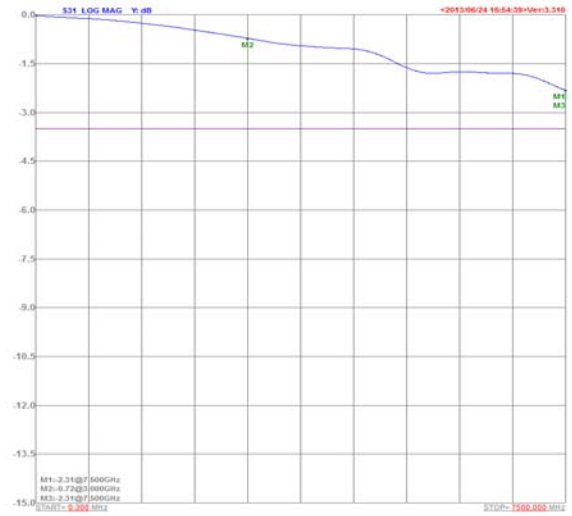

TDR For HDMI Testing:

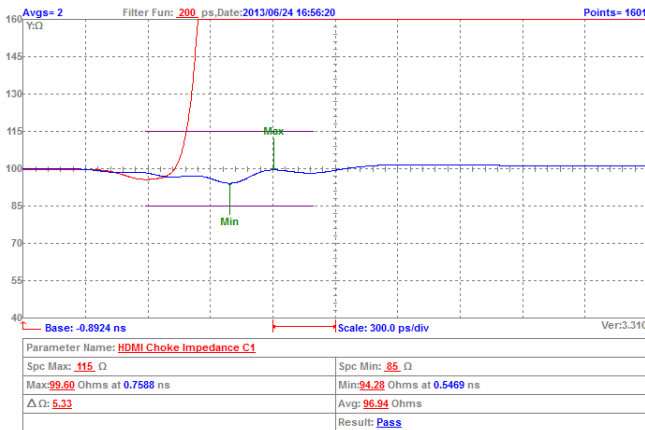

TDR For USB3.0 Testing:

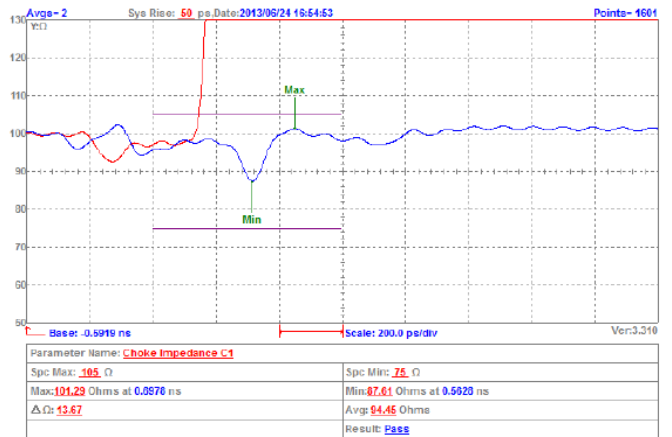

Eye Diagram For HDMI Testing:

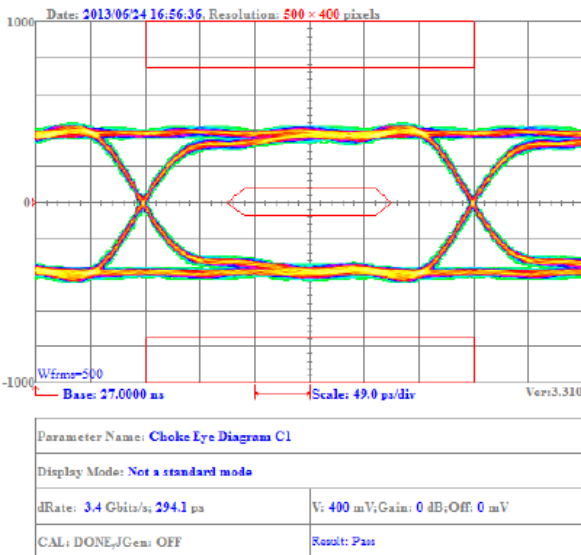

Eye Diagram For USB3.0 Testing:

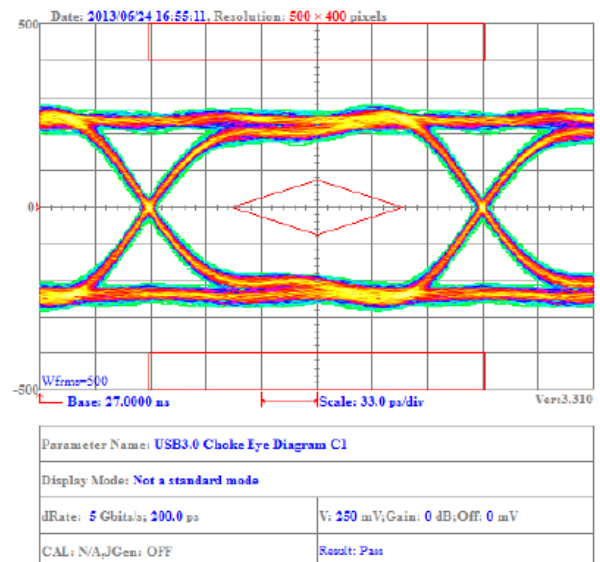

### CMMI11T-900Y-N

Insertion Loss For HDMI Testing:

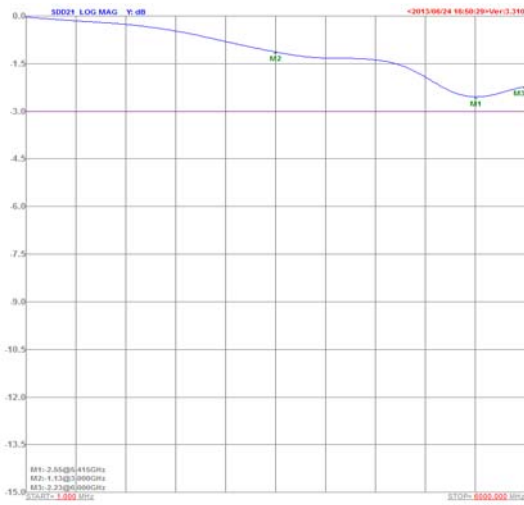

Insertion Loss For USB3.0 Testing:

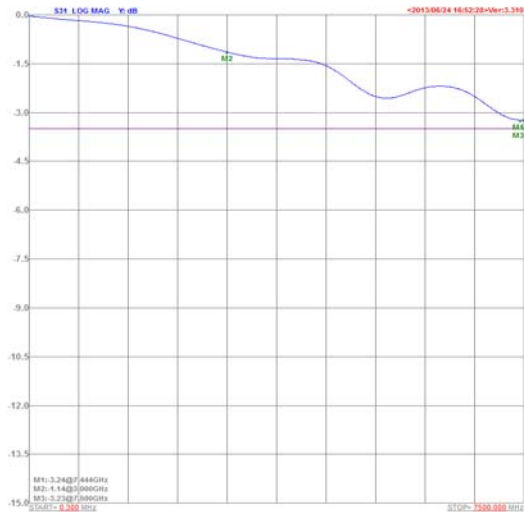

TDR For HDMI Testing:

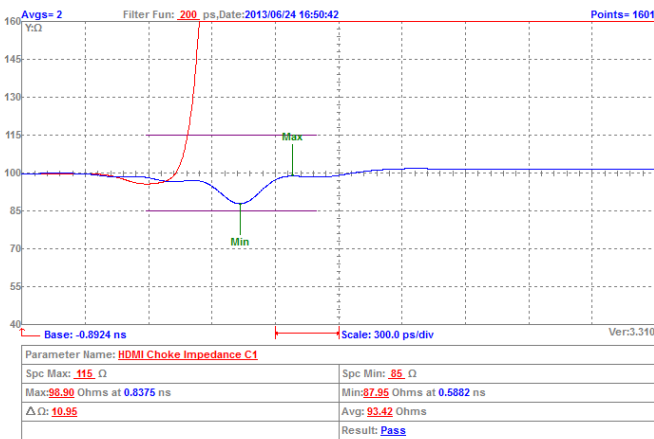

TDR For USB3.0 Testing:

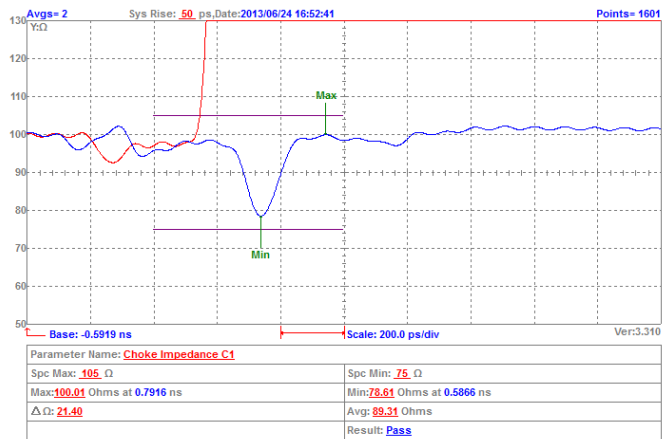

Eye Diagram For HDMI Testing:

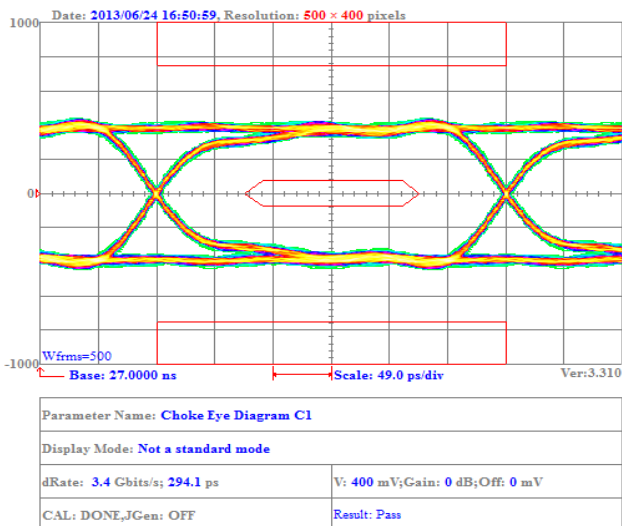

Eye Diagram For USB3.0 Testing:

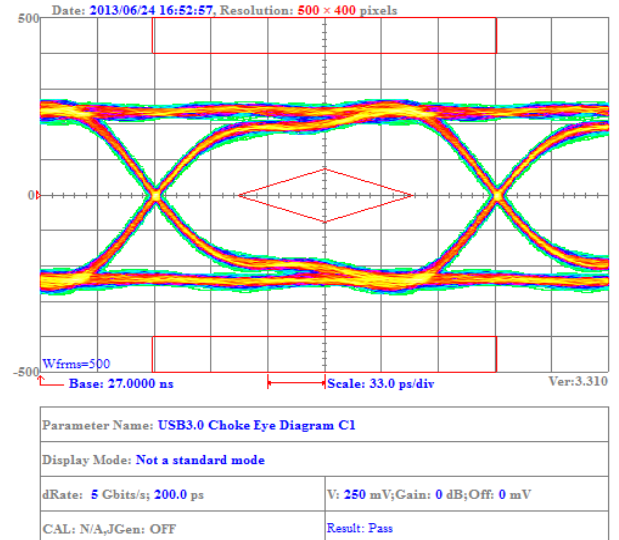

**Electrical Characteristics**

Part Number	Impedance (Ω)	Test Frequency (MHz)	Tolerance (±%)	Idc (mA) Max	Rated Voltage (Vdc)	Rdc (Ω) Max	Insulation Resistance (MΩ) Min
CMMI21T-500Y-N	50	100	25	500	50	0.20	10
CMMI21T-670Y-N	67	100	25	500	50	0.30	10
CMMI21T-900Y-N	90	100	25	330	50	0.30	10
CMMI21T-121Y-N	120	100	25	330	50	0.35	10
CMMI21T-131Y-N	130	100	25	300	50	0.40	10

- When ordering, please specify tolerance and packaging codes
- Tolerance : Y = ±25%
- Packaging : Clear tape and reel { standard }
- Z : HP4286A / HP4287A / Agilent E4991A + Agilent16197A
- Rdc(single line) :CH502BC
- Idc : HP4284A+HP42841A/HP4285A+HP42841A
- Insulation Resistance : Agilent HP4339B
- Operating temperature range from -40°C to 105°C . (Including self - temperature rise )

**Test Instruments :** HP4291A Material/Impedance Analyzer

*Typical Impedance vs. Frequency*

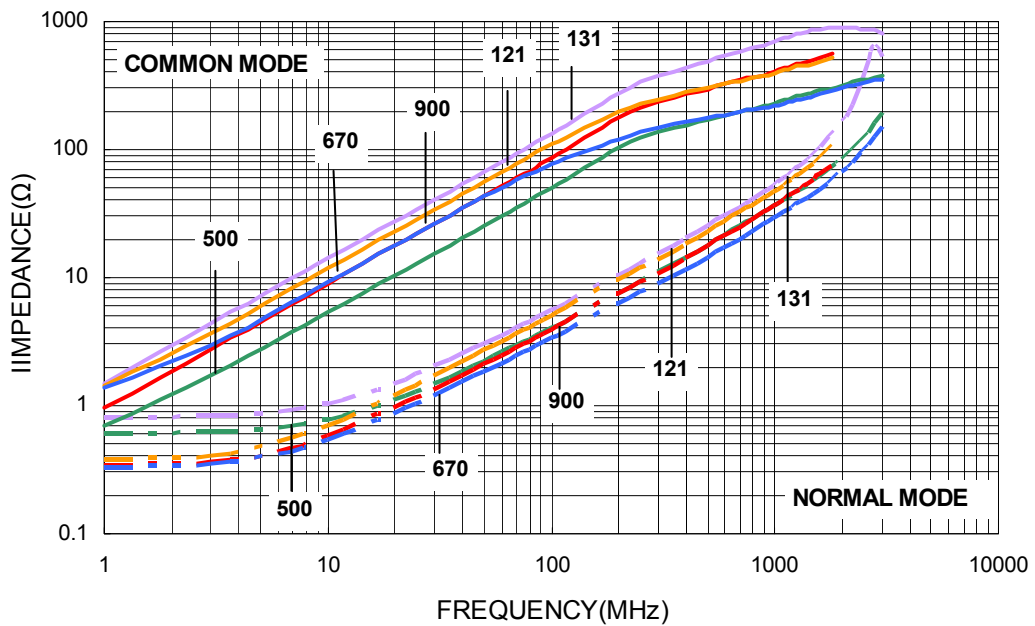

**CMMI21T-500Y-N**

Insertion Loss For HDMI Testing:

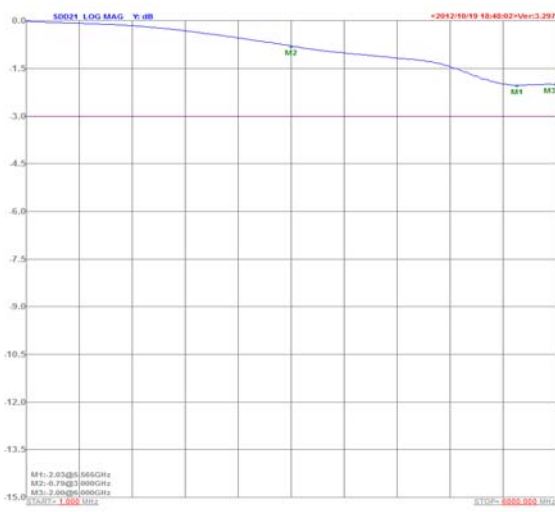

Insertion Loss For USB3.0 Testing:

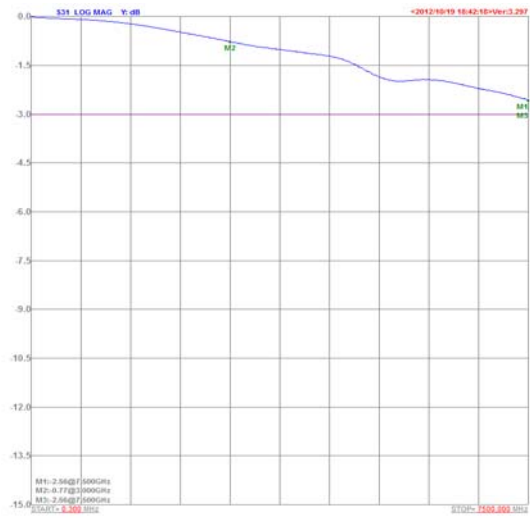

TDR For HDMI Testing:

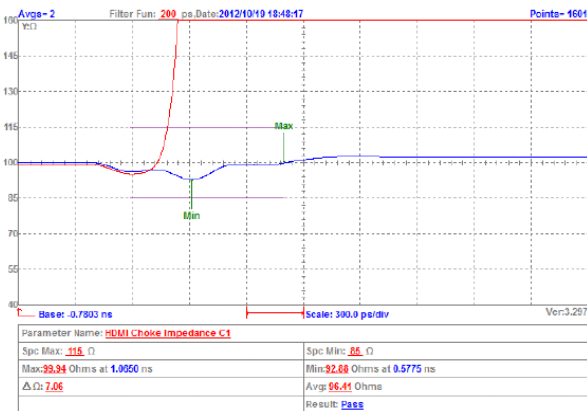

TDR For USB3.0 Testing:

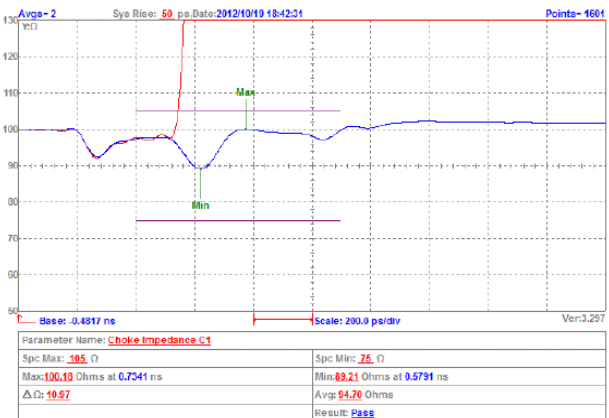

Eye Diagram For HDMI Testing:

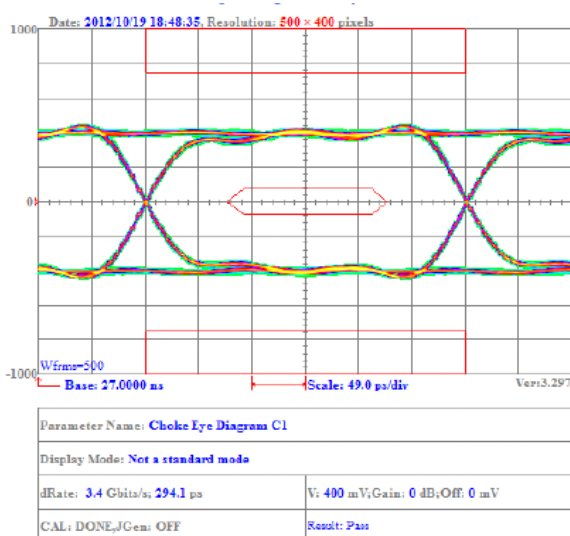

Eye Diagram For USB3.0 Testing:

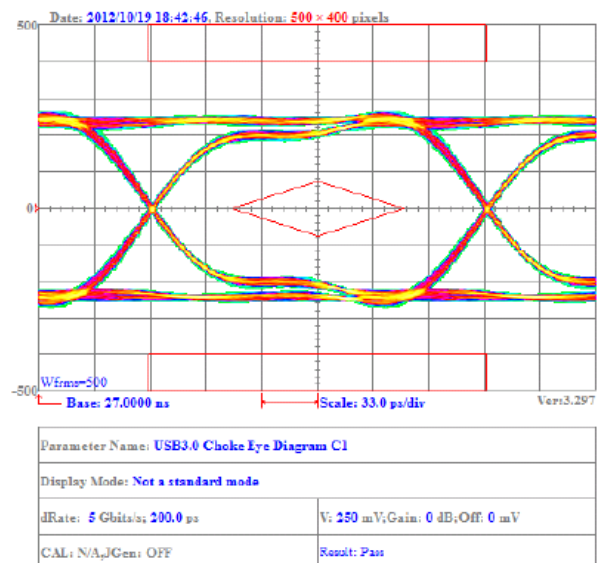

**CMMI21T-670Y-N**

Insertion Loss For HDMI Testing:

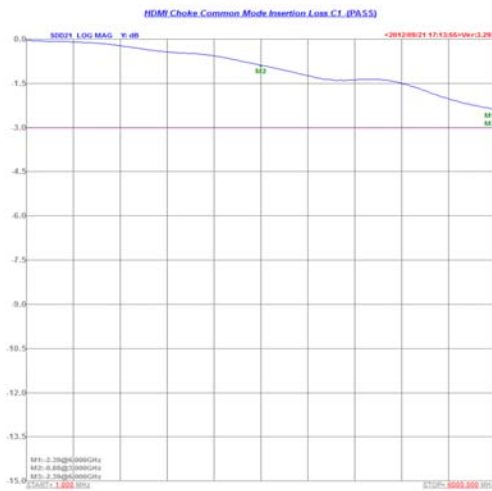

Insertion Loss For USB3.0 Testing:

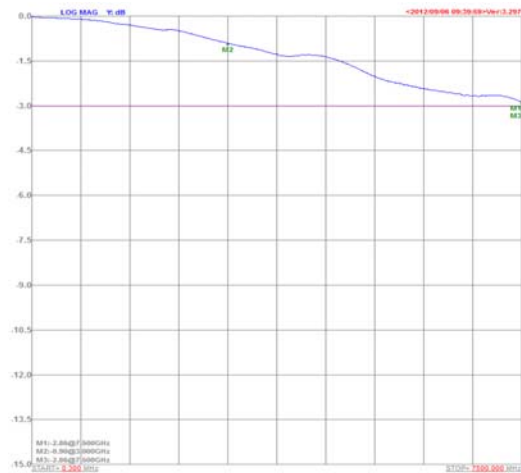

TDR For HDMI Testing:

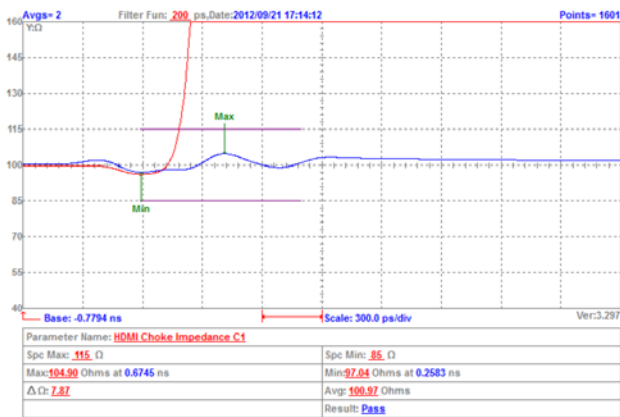

TDR For USB3.0 Testing:

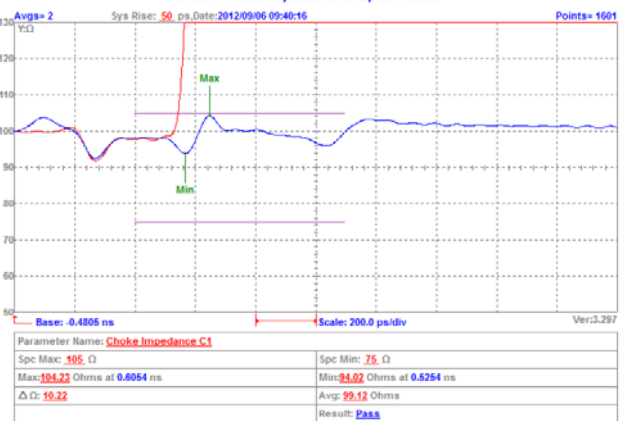

Eye Diagram For HDMI Testing:

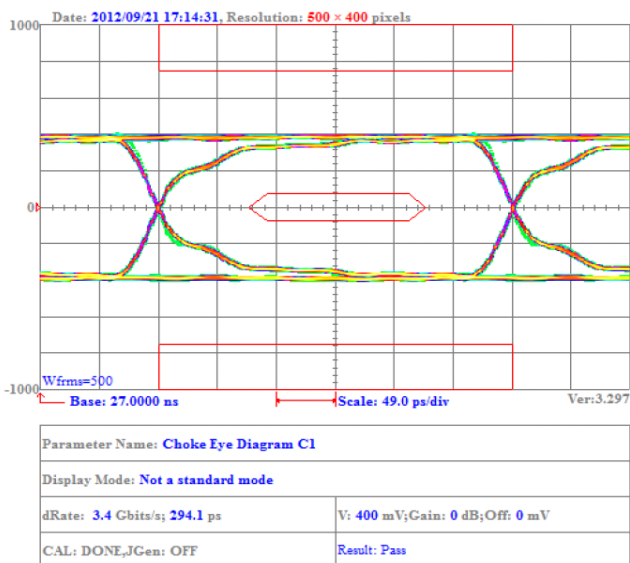

Eye Diagram For USB3.0 Testing:

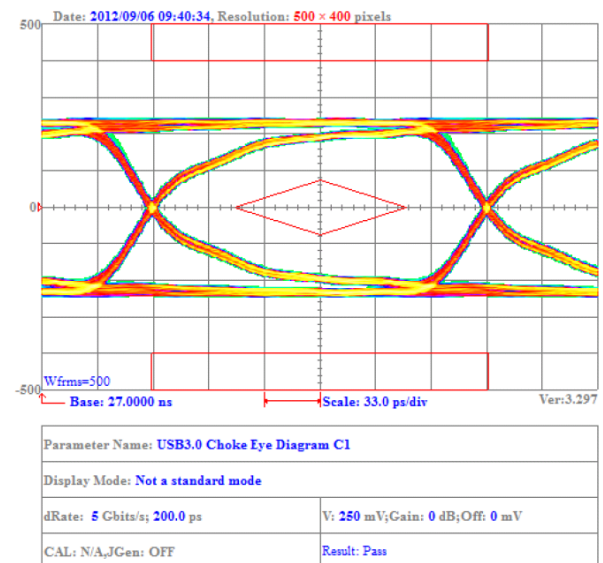

**CMMI21T-900Y-N**

Insertion Loss For HDMI Testing:

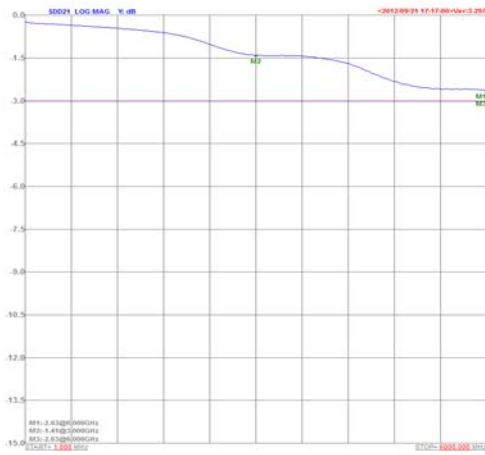

Insertion Loss For USB3.0 Testing:

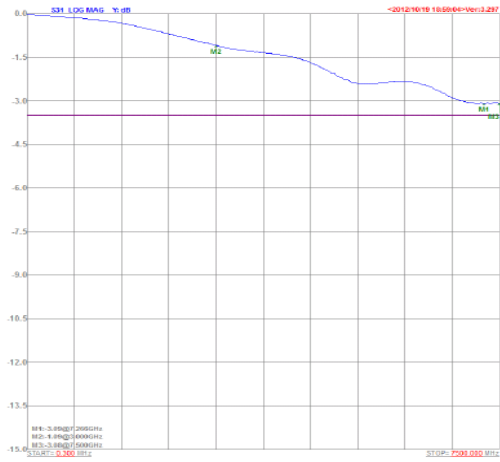

TDR For HDMI Testing:

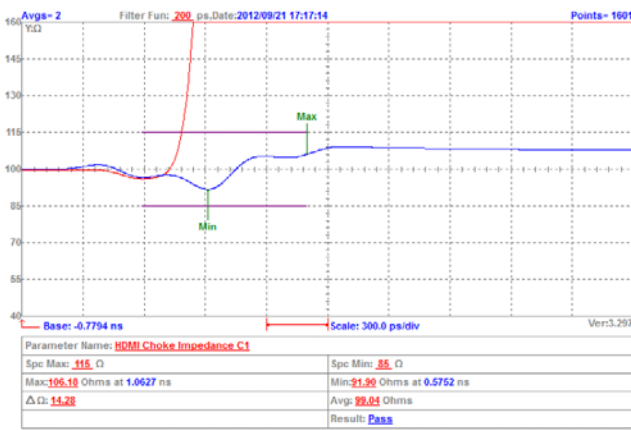

TDR For USB3.0 Testing:

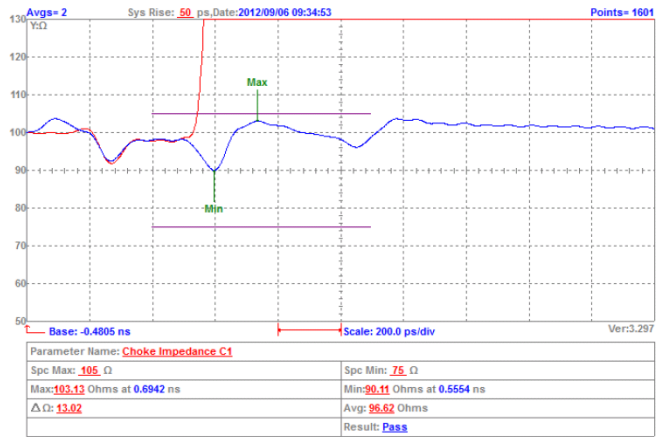

Eye Diagram For HDMI Testing:

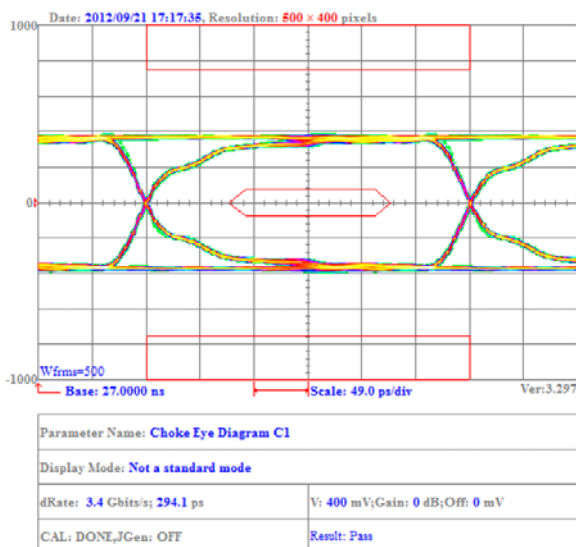

Eye Diagram For USB3.0 Testing:

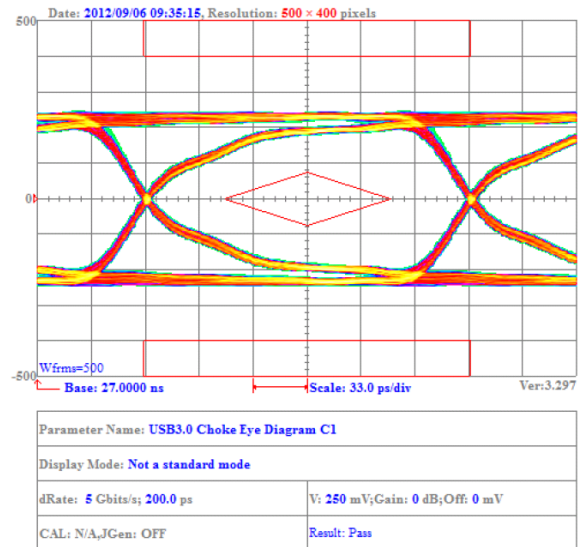



### CMMI21T-121Y-N

Insertion Loss For HDMI Testing:

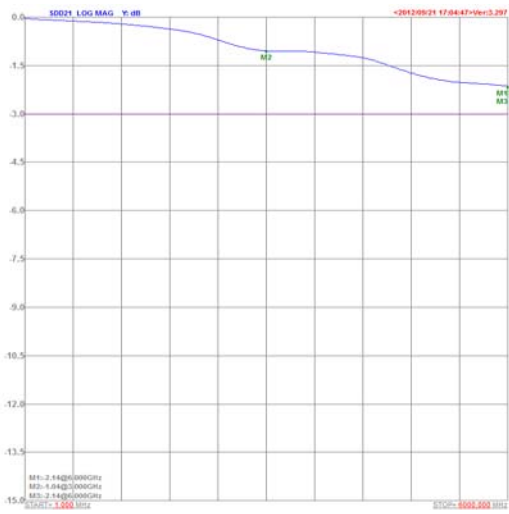

Insertion Loss For USB3.0 Testing:

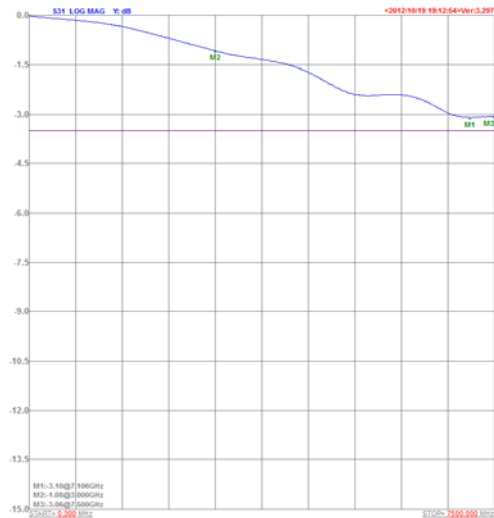

TDR For HDMI Testing:

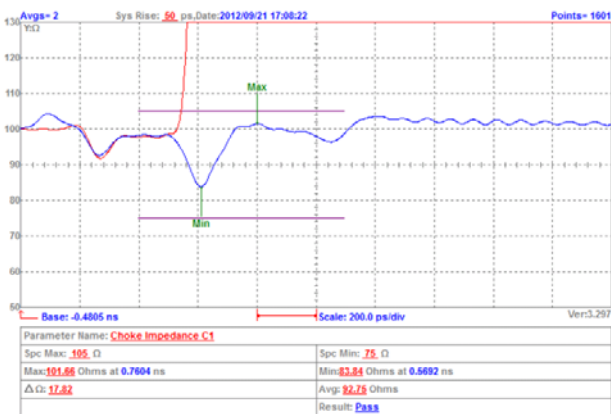

TDR For USB3.0 Testing:

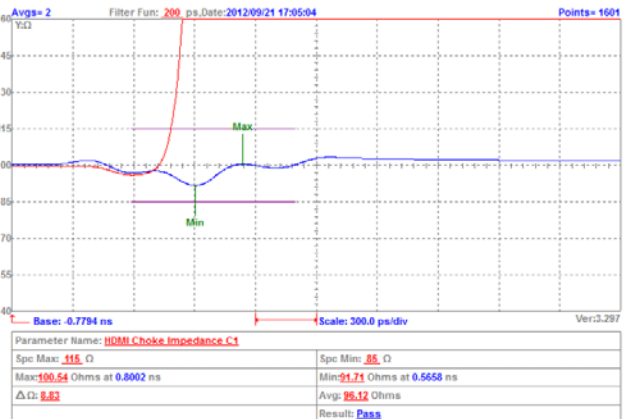

Eye Diagram For HDMI Testing:

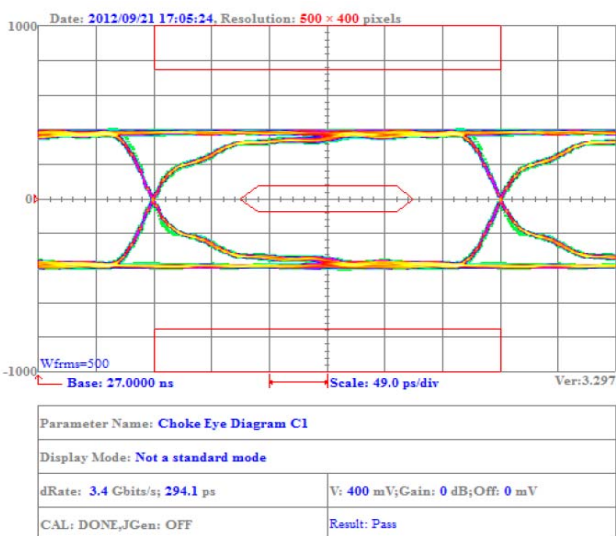

Eye Diagram For USB3.0 Testing:

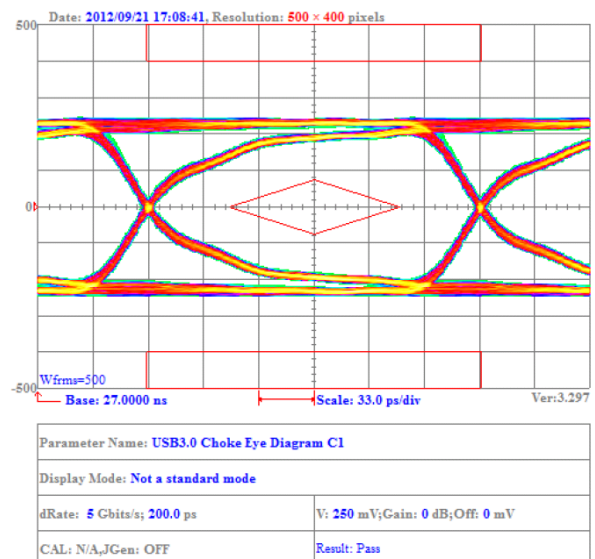

### CMMI21T-131Y-N

Insertion Loss For HDMI Testing:

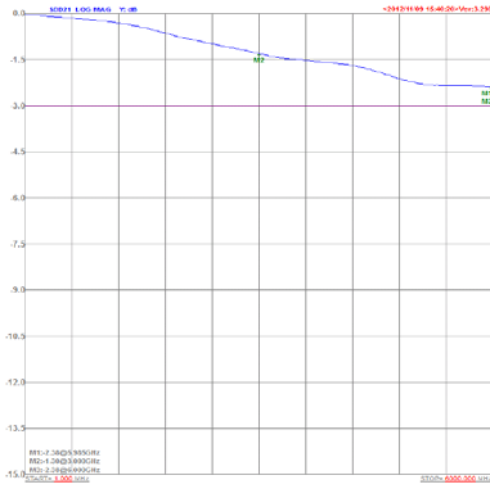

Insertion Loss For USB3.0 Testing:

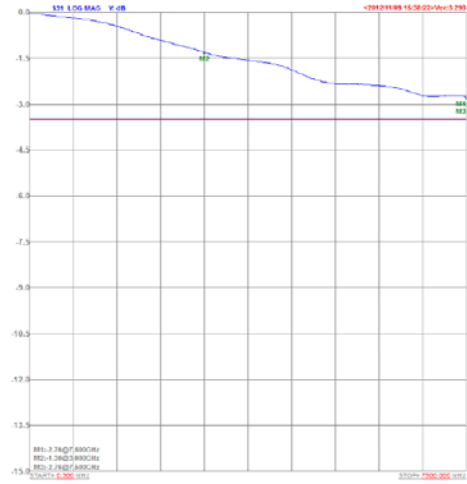

TDR For HDMI Testing:

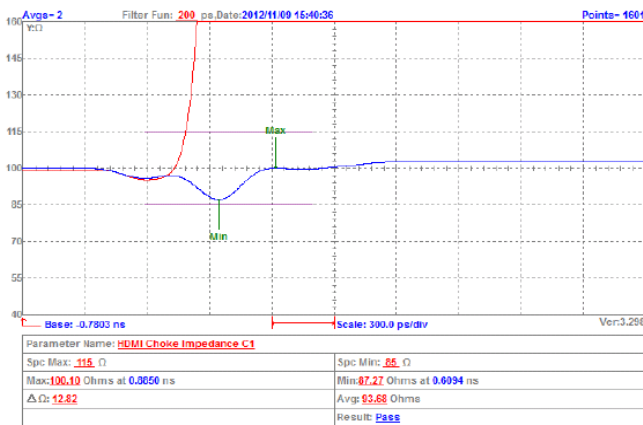

TDR For USB3.0 Testing:

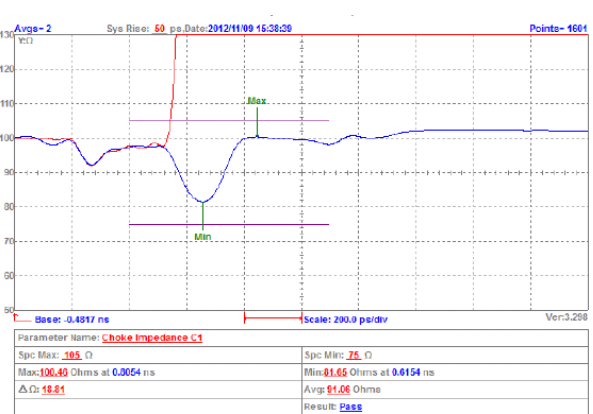

Eye Diagram For HDMI Testing:

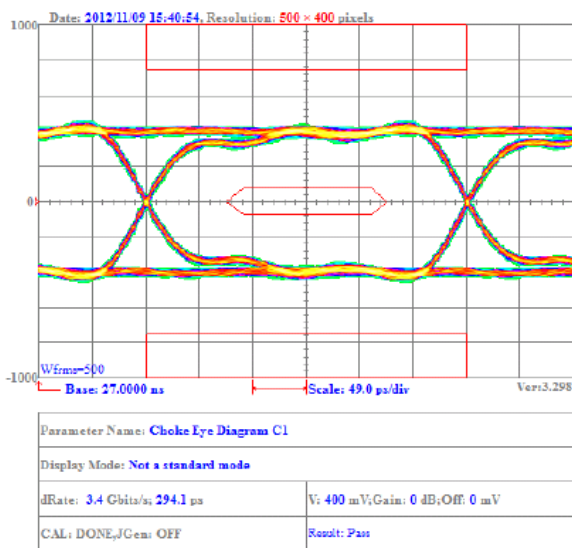

Eye Diagram For USB3.0 Testing:

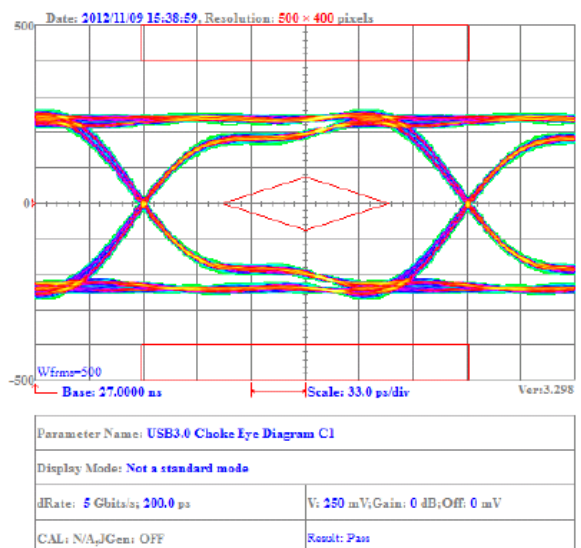

Packaging Specifications

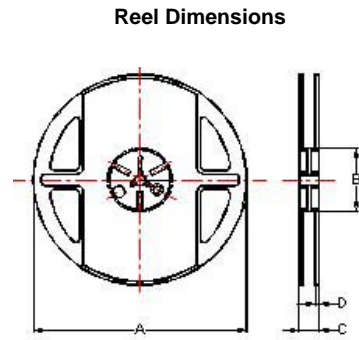
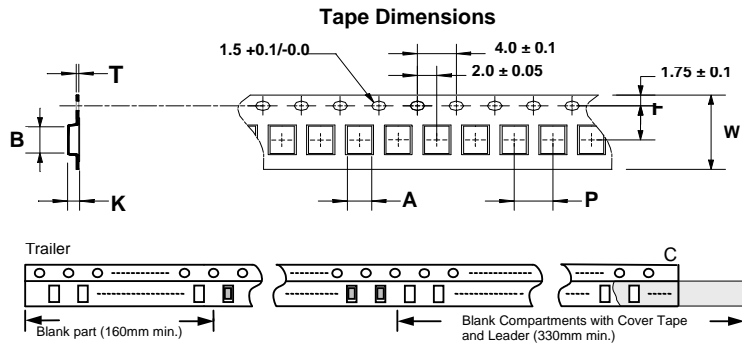

Dimensions in mm

TYPE	Tape Dimensions							Reel Dimensions				Quantity PCS / Reel
	A	B	T	W	P	F	K	A	B	C	D	
CMMI11	1.10	1.40	0.25	8	4	3.5	1.00	178	60	12	1.5	2000
CMMI21	1.50	2.25	0.24	8	4	3.5	1.35	178	60	12	1.5	2000