



U74AC32

CMOS IC

QUADRUPLE 2-INPUT POSITIVE-OR GATE

DESCRIPTION

The **U74AC32** is a quad 2-input positive-OR gate. The device performs the Boolean function $Y=A+B$ or $Y = \overline{A} \bullet \overline{B}$ in positive logic.

FEATURES

- * Operation Voltage Range: 2~6V
- * Inputs Accept Voltages to 6V
- * Max t_{pd} of 7.5 ns at 5V

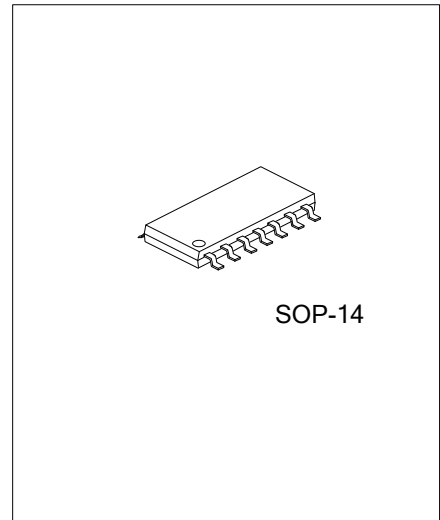

ORDERING INFORMATION

| Ordering Number | | Package | Packing |
|-----------------|----------------|---------|-----------|
| Lead Free | Halogen Free | | |
| U74AC32L-S14-R | U74AC32G-S14-R | SOP-14 | Tape Reel |

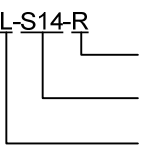
| | |
|--|--|
| <p>U74AC32L-S14-R</p>  <ul style="list-style-type: none"> (1) Packing Type (2) Package Type (3) Lead Plating | <ul style="list-style-type: none"> (1) R: Tape Reel (2) S14: SOP-14 (3) L: Lead Free, G: Halogen Free |
|--|--|

■ PIN CONFIGURATION

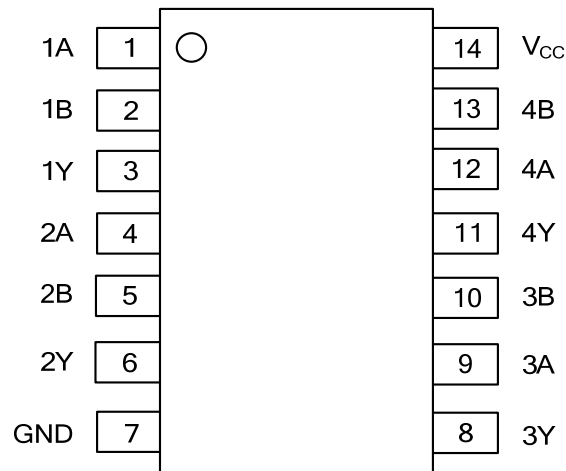

■ FUNCTION TABLE(EACH GATE)

| INPUTS | | OUTPUT |
|--------|---|--------|
| A | B | Y |
| H | X | H |
| X | H | H |
| L | L | L |

L: low voltage level; H: high voltage level; X: don't care

■ LOGIC DIAGRAM,EACH GATE (POSITIVE LOGIC)

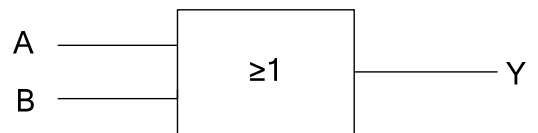
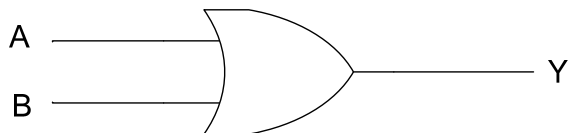

■ ABSOLUTE MAXIMUM RATING (unless otherwise specified) (Note 2)

| PARAMETER | SYMBOL | RATINGS | UNIT |
|--|-----------|--------------------|------|
| Supply Voltage | V_{CC} | -0.5~7.0 | V |
| Input Voltage | V_{IN} | -0.5~ $V_{CC}+0.5$ | V |
| Output Voltage | V_{OUT} | -0.5~ $V_{CC}+0.5$ | V |
| Input Clamp Current ($V_I < 0$ or $V_I > V_{CC}$) | I_{IK} | ±20 | mA |
| Output Clamp Current ($V_O < 0$ or $V_O > V_{CC}$) | I_{OK} | ±20 | mA |
| Output Current ($V_O = 0$ to V_{CC}) | I_{OUT} | ±50 | mA |
| Continuous current through V_{CC} or GND | I_{CC} | ±200 | mA |
| Storage Temperature | T_{STG} | -65 ~ +150 | °C |

Notes: 1. Absolute maximum ratings are those values beyond which the device could be permanently damaged.

Absolute maximum ratings are stress ratings only and functional device operation is not implied.

2. The input and output voltage ratings may be exceeded if the input and output current ratings are observed.

■ RECOMMENDED OPERATING CONDITIONS

| PARAMETER | SYMBOL | MIN | TYP | MAX | UNIT |
|------------------------------------|---------------------|-----|-----|----------|------|
| Supply Voltage | V_{CC} | 2 | | 6 | V |
| Input Voltage | V_{IN} | 0 | | V_{CC} | V |
| Output Voltage | V_{OUT} | 0 | | V_{CC} | V |
| Operating free-air temperature | T_A | -40 | | 85 | °C |
| Input Transition Rise or Fall Rate | $\Delta t/\Delta v$ | | | 8 | ns/V |

■ ELECTRICAL CHARACTERISTICS ($T_A = 25^\circ\text{C}$, unless otherwise specified)

| PARAMETER | SYMBOL | TEST CONDITIONS | MIN | TYP | MAX | UNIT |
|---------------------------|----------|---|------|-------|------|------|
| HIGH-level input voltage | V_{IH} | $V_{CC} = 3V$ | 2.1 | | | V |
| | | $V_{CC} = 4.5V$ | 3.15 | | | |
| | | $V_{CC} = 5.5V$ | 3.85 | | | |
| LOW-level output voltage | V_{IL} | $V_{CC} = 3V$ | | | 0.9 | V |
| | | $V_{CC} = 4.5V$ | | | 1.35 | |
| | | $V_{CC} = 5.5V$ | | | 1.65 | |
| High-Level Output Voltage | V_{OH} | $V_{CC} = 3V, I_{OH} = -50\mu A$ | 2.9 | | | V |
| | | $V_{CC} = 4.5V, I_{OH} = -50\mu A$ | 4.4 | | | |
| | | $V_{CC} = 5.5V, I_{OH} = -50\mu A$ | 5.4 | | | |
| | | $V_{CC} = 3V, I_{OH} = -12mA$ | 2.56 | | | |
| | | $V_{CC} = 4.5V, I_{OH} = -24mA$ | 3.86 | | | |
| Low-Level Output Voltage | V_{OL} | $V_{CC} = 3V, I_{OH} = 50\mu A$ | | 0.002 | 0.1 | V |
| | | $V_{CC} = 4.5V, I_{OH} = 50\mu A$ | | 0.001 | 0.1 | |
| | | $V_{CC} = 5.5V, I_{OH} = 50\mu A$ | | 0.001 | 0.1 | |
| | | $V_{CC} = 3V, I_{OH} = 12mA$ | | | 0.36 | |
| | | $V_{CC} = 4.5V, I_{OH} = 24mA$ | | | 0.36 | |
| Input Leakage Current | I_I | $V_I = V_{CC}$ or GND, $V_{CC} = 5.5V$ | | | ±0.1 | μA |
| | | $V_I = GND$ or $V_{CC}, I_O = 0, V_{CC} = 5.5V$ | | | 2 | μA |
| Quiescent Supply Current | I_{CC} | $V_I = GND$ or $V_{CC}, I_O = 0, V_{CC} = 5.5V$ | | | 2 | μA |
| Input Capacitance | C_I | $V_I = V_{CC}$ or GND, $V_{CC} = 5V$ | | 2.6 | | pF |

■ DYNAMIC CHARACTERISTICS

($C_L=50\text{pF}$, $R_L=500\Omega$, $T_A=25^\circ\text{C}$, unless otherwise specified) (see Figure 1)

| PARAMETER | SYMBOL | TEST CONDITIONS | MIN | TYP | MAX | UNIT |
|---|-----------|-----------------------|-----|-----|-----|------|
| Propagation delay from Input(A or B) to Output(Y) | t_{PLH} | $V_{CC}=3.3V\pm 0.3V$ | 1.5 | 7 | 9 | ns |
| | | $V_{CC}=5V\pm 0.5V$ | 1.5 | 5.5 | 7.5 | ns |
| | t_{PHL} | $V_{CC}=3.3V\pm 0.3V$ | 1.5 | 7 | 8.5 | ns |
| | | $V_{CC}=5V\pm 0.5V$ | 1.5 | 5 | 7 | ns |

■ OPERATING CHARACTERISTICS ($V_{CC}=5V$, $T_A=25^\circ\text{C}$, unless otherwise specified)

| PARAMETER | SYMBOL | TEST CONDITIONS | MIN | TYP | MAX | UNIT |
|-------------------------------|----------|-------------------------------------|-----|-----|-----|------|
| Power Dissipation Capacitance | C_{PD} | $C_L=50\text{pF}$, $f=1\text{MHz}$ | | 40 | | pF |

■ TEST CIRCUIT AND WAVEFORMS

From Output

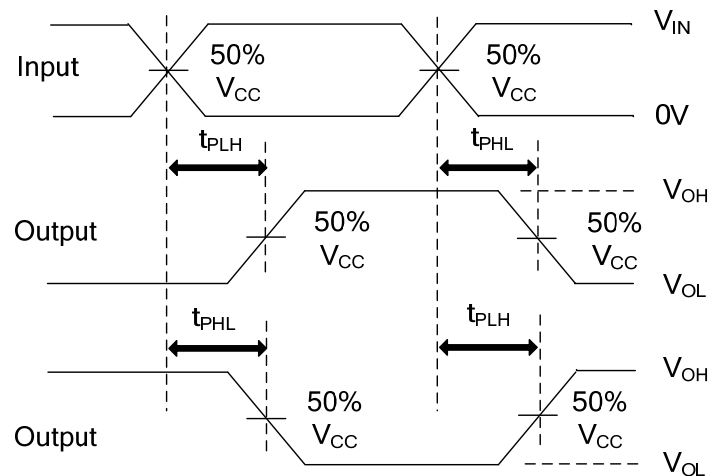
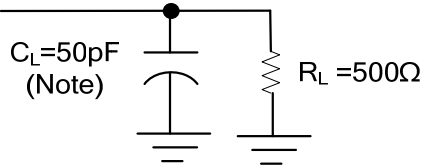

PROPAGATION DELAY TIMES

- Notes:
1. C_L includes probe and jig capacitance.
 2. All input pulses are supplied by generators having the following characteristics:
 $PRR \leq 1\text{MHz}$, $Z_0 = 50\Omega$, $t_r \leq 2.5\text{ns}$, $t_f \leq 2.5\text{ns}$.
 3. The outputs are measured one at a time with one input transition per measurement.

Figure 1. Load Circuit and Voltage Waveforms

UTC assumes no responsibility for equipment failures that result from using products at values that exceed, even momentarily, rated values (such as maximum ratings, operating condition ranges, or other parameters) listed in products specifications of any and all UTC products described or contained herein. UTC products are not designed for use in life support appliances, devices or systems where malfunction of these products can be reasonably expected to result in personal injury. Reproduction in whole or in part is prohibited without the prior written consent of the copyright owner. The information presented in this document does not form part of any quotation or contract, is believed to be accurate and reliable and may be changed without notice.