

isc Silicon NPN Power Transistor

2SD1543

DESCRIPTION

- High Breakdown Voltage-  
:  $V_{CBO}=1500V$  (Min)
- High Switching Speed
- Low Saturation Voltage

APPLICATIONS

- Color TV horizontal output applications

ABSOLUTE MAXIMUM RATINGS( $T_a=25^{\circ}C$ )

SYMBOL	PARAMETER	VALUE	UNIT
$V_{CBO}$	Collector-Base Voltage	1500	V
$V_{CEO}$	Collector-Emitter Voltage	600	V
$V_{EBO}$	Emitter-Base Voltage	5	V
$I_C$	Collector Current- Continuous	2.5	A
$I_B$	Base Current- Continuous	1	A
$P_C$	Collector Power Dissipation @ $T_C=25^{\circ}C$	40	W
$T_J$	Junction Temperature	150	$^{\circ}C$
$T_{stg}$	Storage Temperature Range	-55~150	$^{\circ}C$

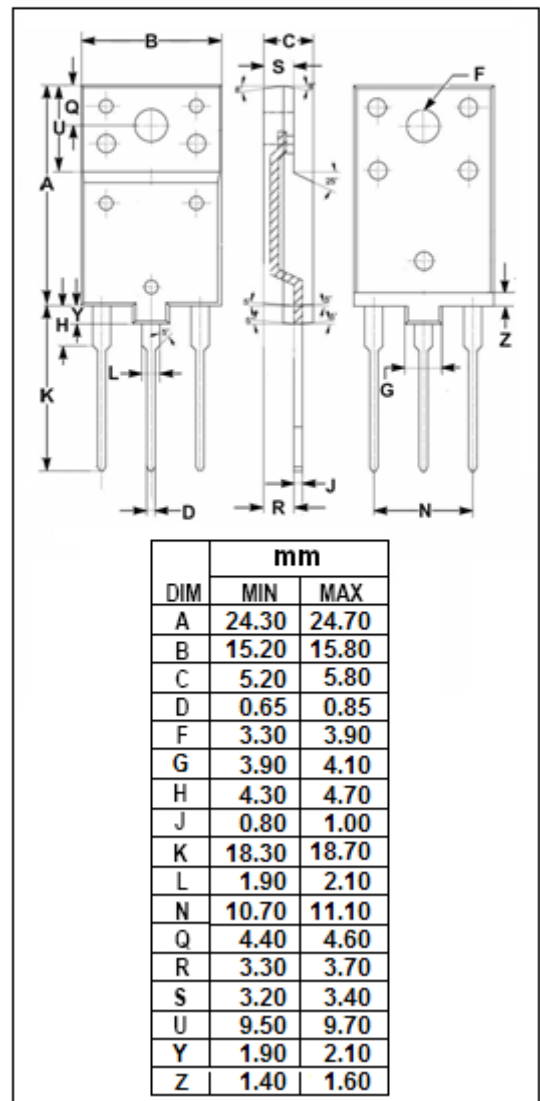
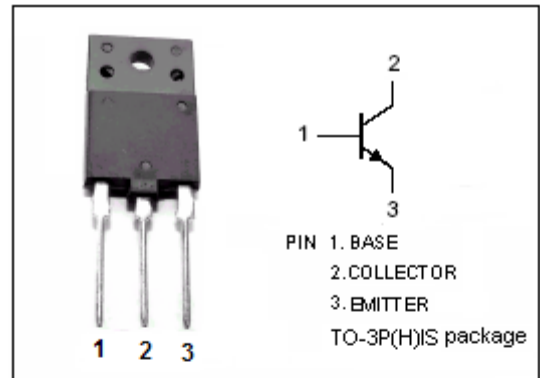

**isc Silicon NPN Power Transistor****2SD1543****ELECTRICAL CHARACTERISTICS** $T_C=25^{\circ}\text{C}$  unless otherwise specified

SYMBOL	PARAMETER	CONDITIONS	MIN	TYP.	MAX	UNIT
$V_{CE(sat)}$	Collector-Emitter Saturation Voltage	$I_C=2\text{A}; I_B=0.6\text{A}$			8.0	V
$V_{BE(sat)}$	Base-Emitter Saturation Voltage	$I_C=2\text{A}; I_B=0.6\text{A}$			1.5	V
$I_{CBO}$	Collector Cutoff Current	$V_{CB}=500\text{V}; I_E=0$			10	$\mu\text{A}$
$I_{EBO}$	Emitter Cutoff Current	$V_{EB}=5\text{V}; I_C=0$			1.0	mA
$h_{FE}$	DC Current Gain	$I_C=0.5\text{A}; V_{CE}=5\text{V}$	8			
$f_T$	Current-Gain—Bandwidth Product	$I_C=0.1\text{A}; V_{CE}=10\text{V}$		3		MHz
$C_{OB}$	Output Capacitance	$I_E=0; V_{CB}=10\text{V}; f_{test}=1.0\text{MHz}$		95		pF
$t_f$	Fall Time	$I_{CP}=2\text{A}, I_{B1(end)}=0.6\text{A}$		0.5	1.0	$\mu\text{s}$