

DATE OF ISSUE : 2008. 04. 10

<h1 style="margin: 0;">SPECIFICATION</h1> <p style="margin: 0;">MODEL : SLTNCW2502AN</p>
--

Approved rank : V<sub>F</sub>(S), CIE(A, B, C, D, E, F, G, H), I<sub>v</sub>(S)

WHITE TOP VIEW

CUSTOMER : \_\_\_\_\_

CUSTOMER :		
DRAWN	CHECKED	APPROVED

SAMSUNG ELECTRO-MECHANICS		
DRAWN	CHECKED	APPROVED

*SAMSUNG ELECTRO-MECHANICS CO., LTD.*  
 314. MAETAN3-DONG, YEONGTONG-KU,  
 SUWON-SI, GYUNGKI-DO, KOREA, 442-743

## Contents

1. Product outline-----	3
2. Absolute Maximum Rating-----	3
3. Characteristics -----	3
4. Chromaticity Diagram -----	4
5. Typical Characteristic Graph -----	5
6. Outline Drawing and Dimension -----	6
7. Reliability Test Items and Conditions ---	7
8. Solder Conditions -----	8
9. Taping Dimension -----	9
10. Label Structure -----	10
11. Lot Number -----	10
12. Reel Packing Structure -----	11
13. Aluminum Vinyl Bag-----	12
14. Precaution for Use -----	13
15. Hazard Substance Analysis-----	15
16. Revision History -----	18

# 1. Product Outline

## 1) Feature

- . Lead Frame Type LED Package ( 5.2 \* 6.0 \* t 1.3mm )
- . Viewing Angle (  $\Delta\theta$  : 120 ° )
- . AlGaInP, GaN/Al<sub>2</sub>O<sub>3</sub> Chip & Long Time Reliability

## 2) Applications

- . Indoor, Outdoor Display and etc.

# 2. Absolute Maximum Rating

- 1). Operation Forward Current Per Chip..... 60 mA
- 2). Peak Pulsed Forward Current Per Chip..... 100 mA  
(Duty 1/10 Pulse Width 10msec)
- 3). Reverse Current..... 85 mA
- 4). Operating Temperature Range ( T<sub>opr</sub> ) ..... -30°C ~ 85°C
- 5). Storage Temperature Range ( T<sub>stg</sub> ) ..... -40°C ~ 100°C

# 3. Characteristics

## Electrical properties

( Ta : 25°C )

Item	Symbol	Conditions	Rank	Min.	Typ.	Max.	Unit
Forward Voltage (*)	V <sub>F</sub>	I <sub>F</sub> = 100 mA	S	2.9	-	3.6	V
Reverse Voltage(**)	V <sub>r</sub>	I <sub>R</sub> = 10mA	-	0.6	-	2.0	V

## Chromaticity Coordinate

( Ta : 25°C )

Item	Condition	Rank	x				y				
Chromaticity Coordinate (*)	IF=100mA	S rank	A	0.2771	0.2869	0.2833	0.2725	0.2507	0.2698	0.2763	0.2564
			B	0.2869	0.2976	0.2951	0.2833	0.2698	0.2906	0.2981	0.2763
			C	0.2725	0.2833	0.2783	0.2655	0.2564	0.2763	0.2854	0.2650
			D	0.2833	0.2951	0.2919	0.2783	0.2763	0.2981	0.3077	0.2854
		L rank	E	0.2976	0.3081	0.3065	0.2951	0.2906	0.3110	0.3192	0.2981
			F	0.3081	0.3190	0.3178	0.3065	0.3110	0.3322	0.3041	0.3192
			G	0.2951	0.3065	0.3046	0.2919	0.2981	0.3192	0.3285	0.3077
			H	0.3065	0.3178	0.3165	0.3046	0.3192	0.3401	0.3480	0.3285

## Luminous Intensity

( Ta : 25°C )

Item	Symbol	Conditions	Rank	Min.	Typ.	Max.	Unit
Luminous Intensity (*)	I <sub>v</sub>	I <sub>F</sub> = 100mA	S	6.5	8.5	11.4	cd

\* Tolerance : V<sub>F</sub>:±0.1, I<sub>v</sub>:±5%, x,y:±0.01

\* Luminous intensity measuring equipment : CAS140 B

\*\* Value for one LED device.

## 4. Chromaticity Diagram

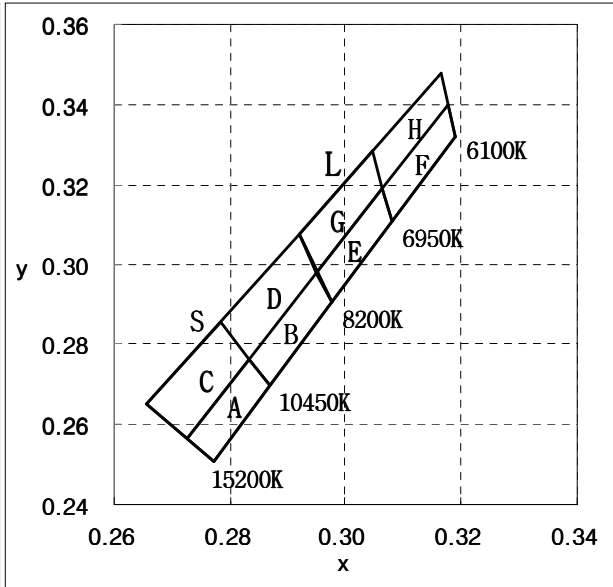
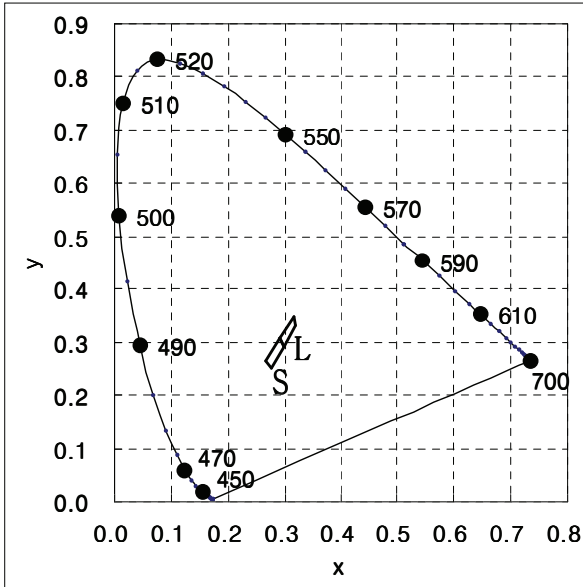

\*  $S=A+B+C+D$   
 $L=E+F+G+H$

※ Approved Rank

$V_F$	CIE	$l_v$
S	A, B, C, D, E, F, G, H	S

\* Each reel contains only one of the A, B, C, D, E, F, G or H, a segment (1/8) of the CIE rank.

# 5. Typical Characteristics Graph

\* These graphs show typical values.

( Ta : 25°C )

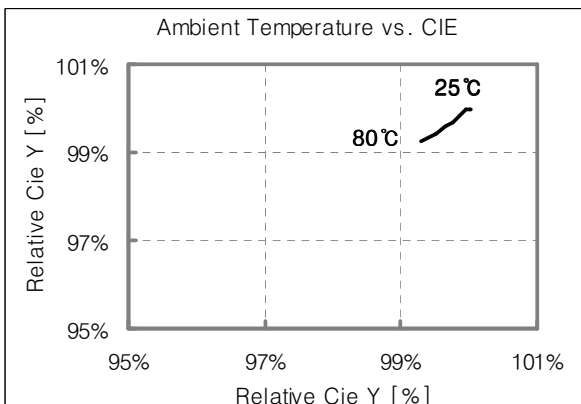
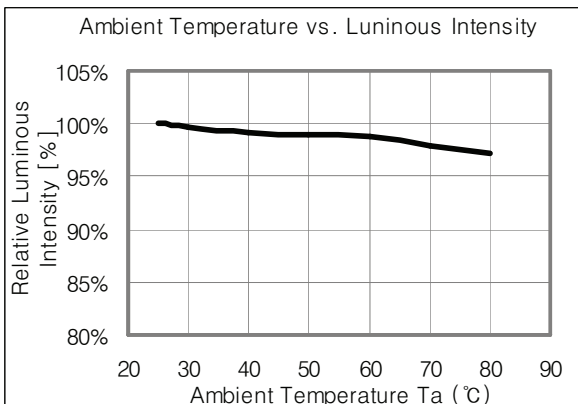
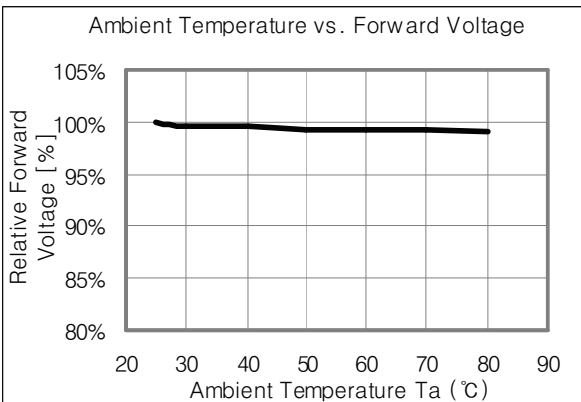
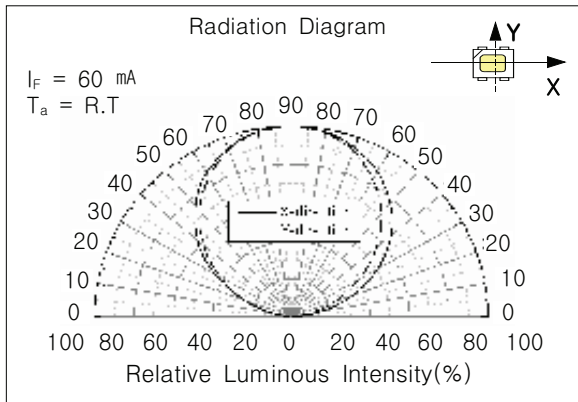
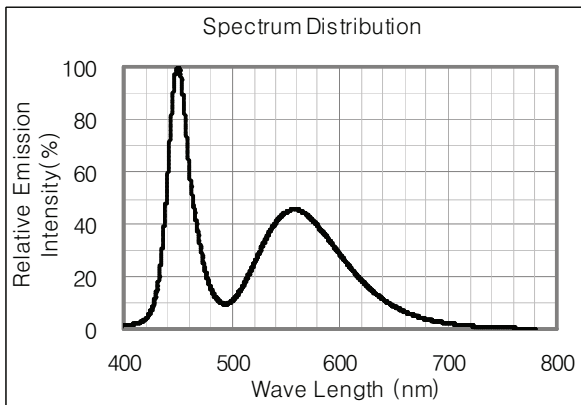
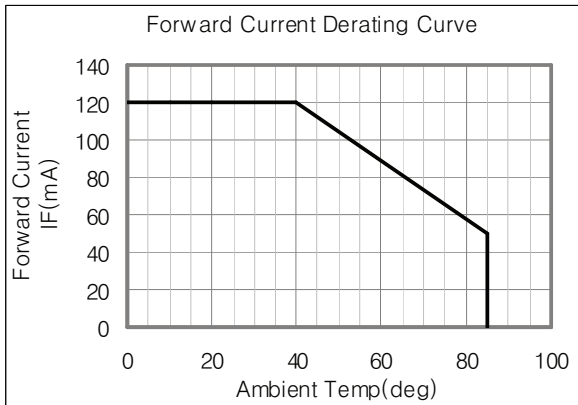
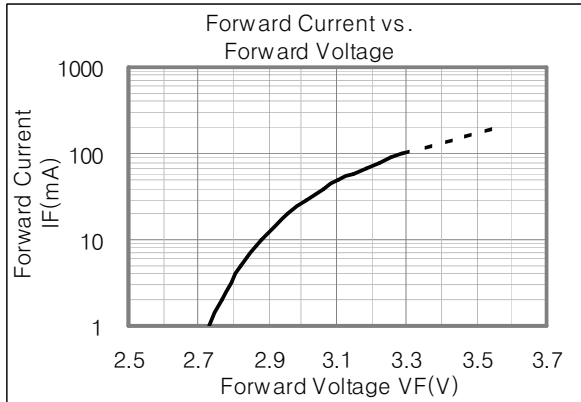
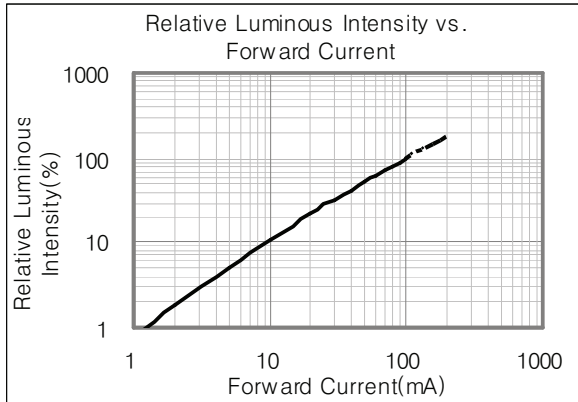

## 6. LED Package Outline Dimensions

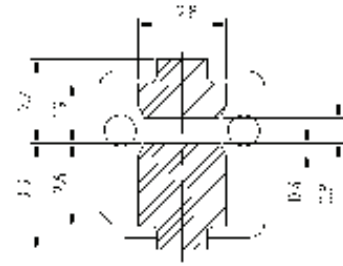
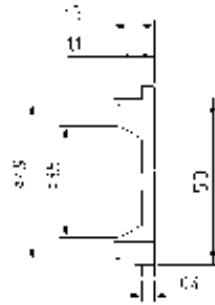
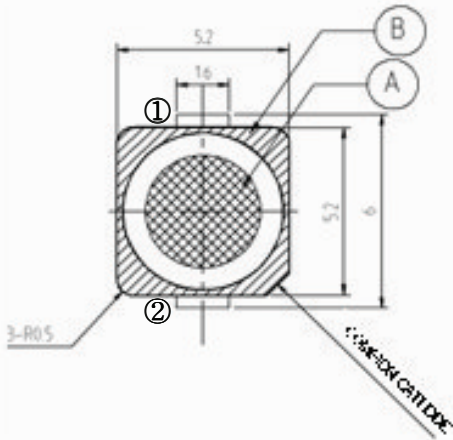

1. Tolerance is  $\pm 0.1\text{mm}$ .
2. Do not place pressure on the encapsulating resin ('A').
3. The maximum compressing force is 15N on the polymer ('B').

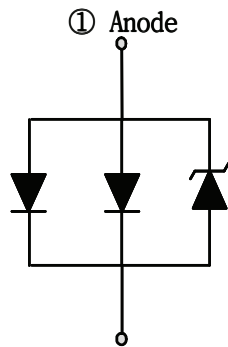

② Cathode  
Circuit Diagram

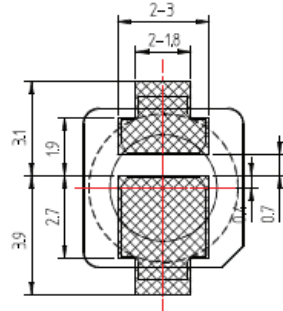
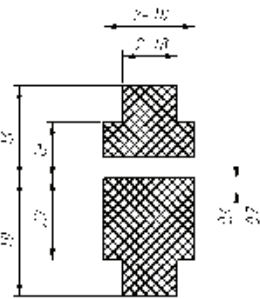

Land Pattern

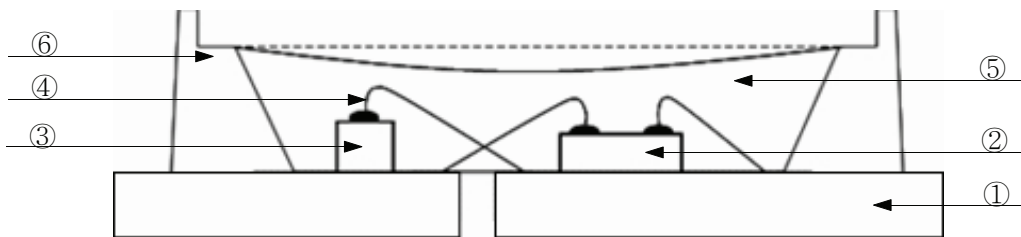

NUMBER	ITEM	MATERIAL
①	FRAME	Copper Frame(Silver Plated)
②	LED CHIP	GaN/Al <sub>2</sub> O <sub>3</sub>
③	Zener Diode	Si
④	WIRE	Gold Wire
⑤	RESIN	Silicone + Phosphor
⑥	PACKAGE	Heat-resistant Polymer

## 7. Reliability Test Items and Conditions

### 1) Test Items

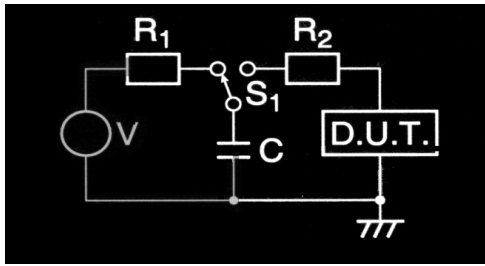
Test Item	Test Conditions	Test Hours/Cycles	Sample No
Room Temperature life test	25°C±3°C, DC120 mA	500 h	50
High Temperature humidity life test	60°C±3°C, 95%±2%RH, DC90 mA	500 h	50
High Temperature life test	85°C±3°C, DC50mA	500 h	50
Low Temperature life test	-30°C±3°C, DC120 mA	500 h	50
High Temperature Storage	Ta=100°C±3°C	500 h	22
Low Temperature Storage	Ta=-40°C±3°C	500 h	22
High Temperature humidity Storage	60°C±3°C, 95%±2%RH	500 h	22
Thermal Shock	-40°C ~ 100°C 0.5 h      0.5 h	100 cycles	50
Temperature humidity Cycle	25°C ~ 65°C ~ -10°C 24hrs/1cycle, 95%RH	10 cycles	22
Reflow (Pb-Free)	Peak 260±5°C for 10sec	3 times	22
ESD(HBM)	 <p>-R1:10MΩ , R2:1.5KΩ , C:100pF</p>	5 times	5
On/Off test	50°C±3°C, 95%±2%RH, DC120 mA, On/2sec, Off/2sec	108000 cycles	50

## 2) Criteria for Judging the Damage

Item	Symbol	Test Condition	Limit	
			Min	Max
Forward Voltage	V <sub>F</sub>	I <sub>F</sub> = 100mA	-	U.S.L.*1.2
Luminous Intensity	I <sub>V</sub>	I <sub>F</sub> = 100mA	L.S.L.*0.5	-

\* USL : Upper Standard Level      LSL : Lower Standard Level

## 8. Solder Conditions

### 1) Reflow Conditions ( Pb Free )

Reflow Frequency : 2 times max.

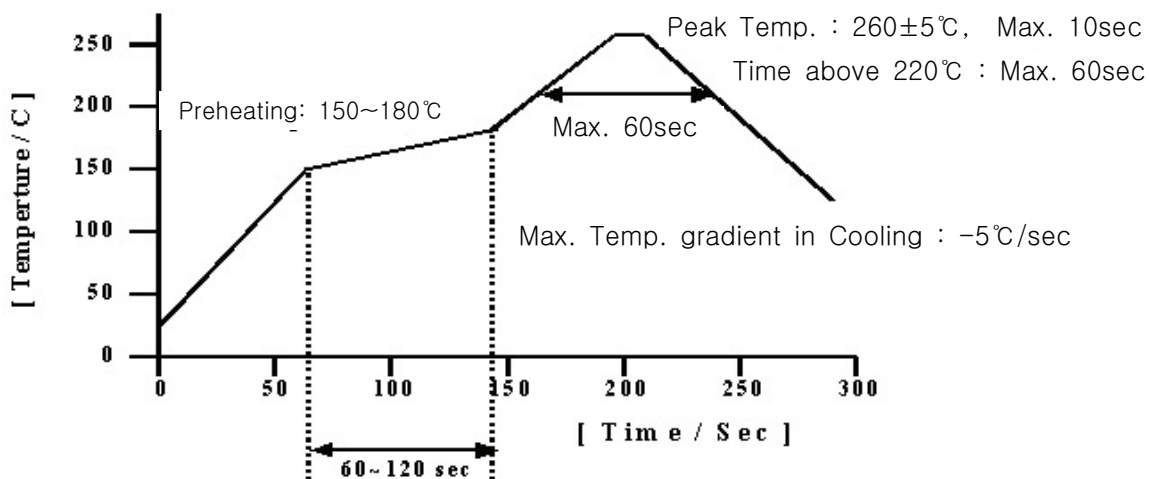

### 2) For Manual Soldering

Not more than 5 seconds @MAX $300^\circ\text{C}$ , under soldering iron.



## 9. Taping Dimension

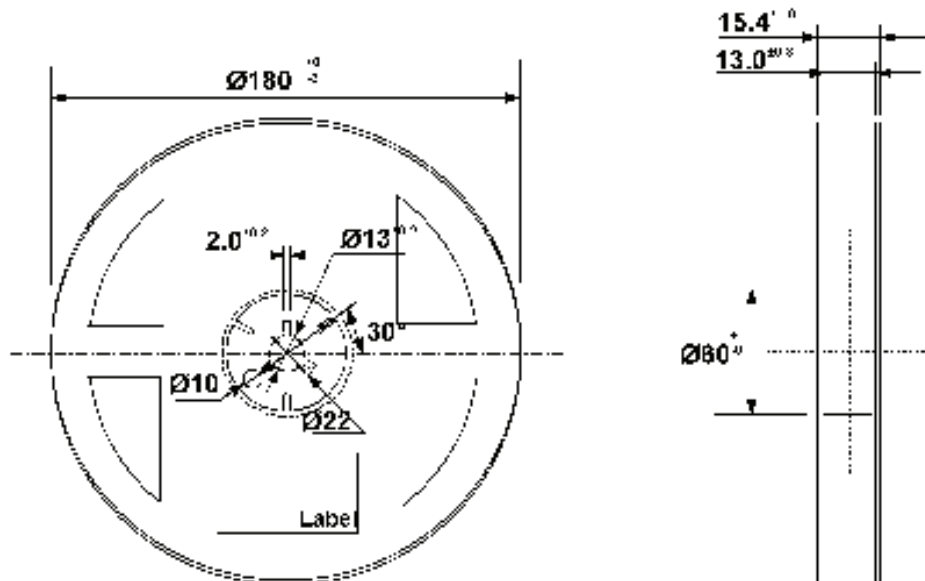
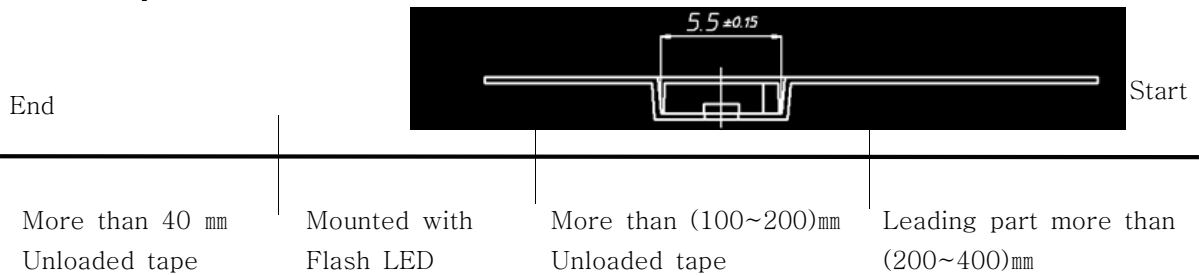
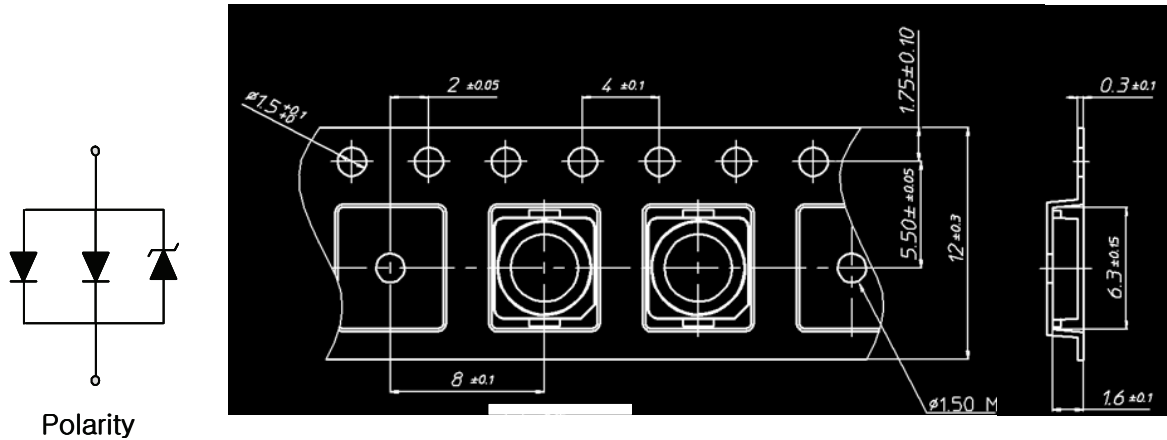

Tolerance  $\pm 0.2$  , Unit:mm

- (1) Quantity : The quantity/reel to be 1000pcs.
- (2) Cumulative Tolerance : Cumulative tolerance/10 pitches to be  $\pm 0.2$  mm
- (3) Adhesion Strength of Cover Tape : Adhesion strength to be 0.1~0.7N when the cover tape is turned off from the carrier tape at  $10^\circ$  angle to be the carrier tape.
- (4) Packaging : P/N, Manufacturing data code no. and quantity to be indicated on a damp proof package.

## 10. Label Structure

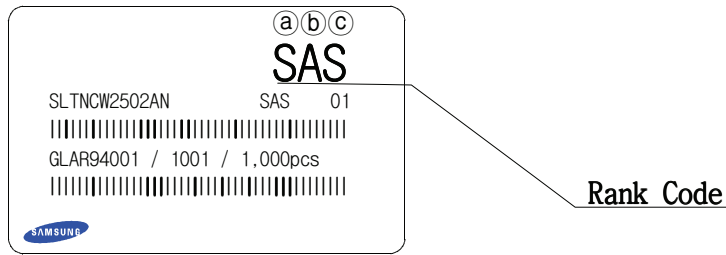

N.B) Denoted rank is the only example.

### Rank Code

- Ⓐ : Forward Voltage( $V_F$ ) Rank (refer to page. 3)
- Ⓑ : Chromaticity Coordinate Rank (refer to page. 3)
- Ⓒ : Luminous Intensity( $I_v$ ) Rank (refer to page. 3)

## 11. Lot Number

The Lot number is composed of the following characters

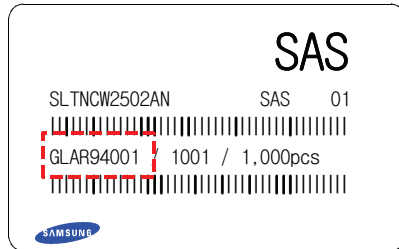

- ◎◇◆□■△△△ / |▲▲▲ / 1000PCS
- : Production Site (S:SEMCO, G:Gosin China)
- ◎ : L (LED)
- ◇ : Product State (A:Normality, B: Bulk, C:First Production, R:reproduction, S:Sample)
- ◆ : Year (Q:2006, R:2007, S:2008...)
- : Month (1 ~ 9, A, B)
- : Day (1 ~ 9, A, B ~ V)
- △ : SEMCO. Product number (1 ~ 999)
- ▲ : Reel Number (1 ~ 999)

## 12. Reel Packing Structure

### Reel

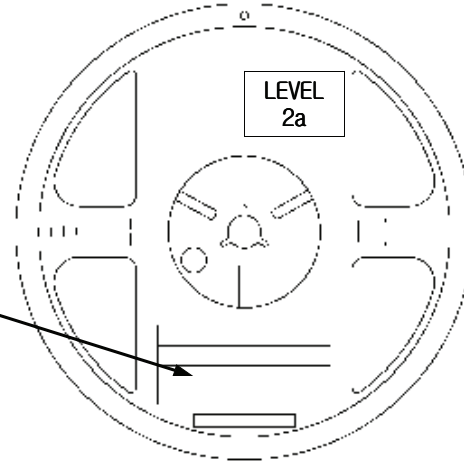

### Aluminum Vinyl Bag

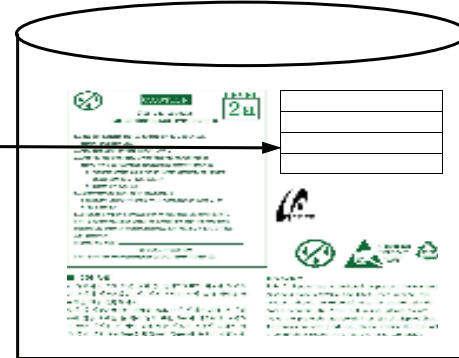
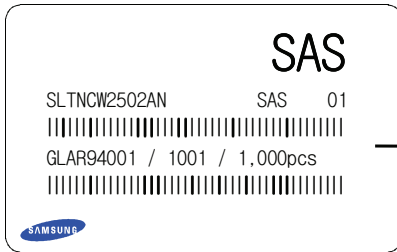

Material : Paper(SW3B(B))

TYPE	SIZE(mm)		
	L	W	H
7inch	245	220	182

### ① SIDE

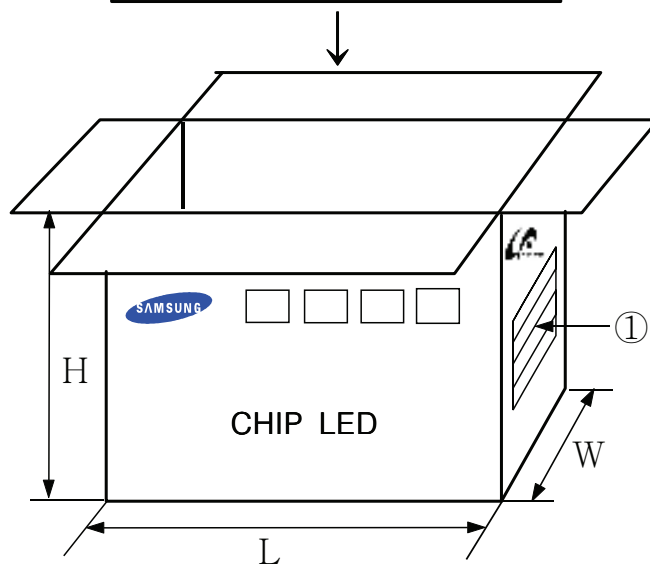
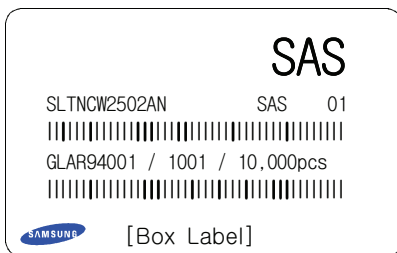

### 13. Aluminum Vinyl Bag



**CAUTION**

This bag contains  
**MOISTURE SENSITIVE DEVICES**

**LEVEL 2a**

- Shelf life in sealed bag: 12 months at <math><40^{\circ}\text{C}</math> and <math><90\%</math> relative humidity (RH)
- Peak package body temperature: <math>240^{\circ}\text{C}</math>
- After this bag is opened, devices that will be subjected to reflow solder or other high temperature processes must be:
  - Mounted within 672 hours at factory conditions of equal to or less than <math>30^{\circ}\text{C}</math> / <math>60\%</math> RH, or
  - Stored at <math><10\%</math> RH
- Devices require bake, before mounting, if:
  - Humidity Indicator Card is > 65% when read at <math>23\pm 5^{\circ}\text{C}</math>, or
  - 2a is not met.
- If baking is required, devices must be baked for 1 hours at <math>60\pm 5^{\circ}\text{C}</math>

Note: If device containers cannot be subjected to high temperature or shorter bake times are desired, reference IPC/JEDEC J-STD-033 for bake procedure.

Bag seal due date: \_\_\_\_\_  
(if blank, see code label)

Note: Level and body temperature by IPC/JEDEC J-STD-020



**SAS**

SLTNCW2502AN SAS 01

GLAR94001 / 1001 / 1,000pcs

SAMSUNG





**주의 사항**

이 알루미늄 지퍼 백은 습기 및 정전기로부터 제품을 보호하기 위하여 제작되었습니다. 개봉 후에는 즉시 솔더 작업을 실시하는 것을 권장합니다.

습기 및 정전기로부터 제품을 보호 하기 위해서 개봉 후 사용하지 않는 자재는 본 팩에 넣어 보관 하시기 바랍니다. 사용하지 않는 자재를 본 팩에 넣을 때는 반드시 동봉된 드라이 팩과 함께 넣고 지퍼부분을 완전히 밀봉하여 주시기 바랍니다.

**Important**

This Al Zipper bag is designed to protect the enclosed products from moisture and ESD. Once opened, the products should be soldered onto the printed circuit board immediately. When not in use, please do not leave the products unprotected by the Al Zipper Bag. To repack unused products, please ensure the zip-lock is completely sealed with the dry pack left inside.

### Silica gel & Humidity Indicator Card in Aluminum Vinyl Bag



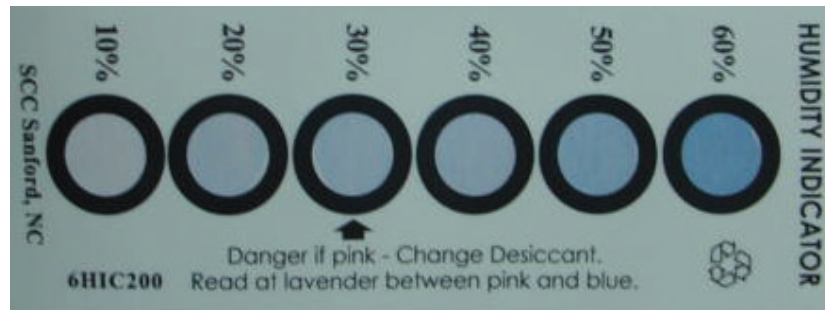

SCC Sanford, NC

6HIC200

Danger if pink - Change Desiccant.  
Read at lavender between pink and blue.

## 14. Precaution for Use (취급상 주의사항)

- 1) For over-current-proof function, customers are recommended to apply resistors to prevent sudden change of the current caused by slight shift of the voltage.  
과전류 방지를 위해 전압의 미세한 이동에 의해 야기되는 전류의 순간 변화를 방지하기 위해 저항 등의 설치를 권장함.
- 2) This device should not be used in any type of fluid such as water, oil, organic solvent, etc. When washing is required, IPA is recommended to use.  
제품은 물, 오일, 유기물과 같은 액체 타입에서의 사용은 제한되며, 세정이 필요할 시에는 IPA 사용을 권장함.
- 3) When the LEDs illuminate, operating current should be decided after considering the ambient maximum temperature.  
LED의 발광 시, 동작 전류는 주변 최고온도를 고려하여 결정되어야 함.
- 4) LEDs must be stored in a clean environment.  
If the LEDs are to be stored for 3 months or more after being shipped from SEMCO, they should be packed by a sealed container with nitrogen gas injected.  
(Shelf life of sealed bags: 12 months, temp. 0~40°C, 20~70%RH)  
LED의 보관은 청정한 환경에서 보존되어야 하며, 만약 삼성전기로부터 공급받는 후 3개월 또는 그 이상 보관이 필요하다면 질소 가스를 동봉한 보존용기에 보관되어야 함.  
(보존 bag의 수명 : 12 개월, 보존 온도 0~40°C, 습도 20~70%RH)
- 5) After storage bag is open, device subjected to soldering, solder reflow, or other high temperature processes must be:  
보존 Bag이 개봉된 후에, 납땀이나 reflow등의 높은 온도에 노출되는 제품은 다음의 사항에 부합되어야 함.
  - a. Mounted within 168 hours (7 days) at an assembly line with a condition of no more than 30°C/60%RH,  
a. 제품은 30°C/60%RH보다 같거나 낮은 조립조건에서 168시간(7일)이내에 조립되어야 함.
  - b. Stored at <10% RH.  
b. 10% 이하의 상대습도에서 보관되어야 함.
- 6) Repack unused Products with anti-moisture packing, fold to close any opening and then store in a dry place.  
사용하지 않은 제품은 방습팩에 넣어 개봉 부위를 닫아서 다시 포장한 후, 건조한 장소에서 보관할 것을 권장함.

7) Devices require baking before mounting, if humidity card reading is  $>65\%$  at  $23\pm 5^{\circ}\text{C}$ .

만약 습도표시카드의 수치가  $23\pm 5^{\circ}\text{C}$ 에서 65% 이상이라면, 제품 실장 전에 baking하여야 함.

8) Devices must be baked for 24hours at  $65\pm 5^{\circ}\text{C}$ , if baking is required.

만약 baking이 필요하다면, 제품은  $65\pm 5^{\circ}\text{C}$ 에서 24시간 정도 baking 되어야 함.

9) The LEDs are sensitive to the static electricity and surge. It is recommended to use a wrist band or anti-electrostatic glove when handling the LEDs.

LED는 정전기 및 서지에 민감한 제품이므로, LED 제품을 다룰 시에는 정전기 방지장갑이나 손목밴드를 사용하기를 권장함.

If voltage exceeding the absolute maximum rating is applied to LEDs, it may cause damage or even destruction to LED devices.

만약 절대 허용치를 초과하는 전압이 LED에 가해지면, LED 소자는 파괴되거나 손상될 수 있음.

Damaged LEDs may show some unusual characteristics such as increase in leak current, lowered turn-on voltage, or abnormal lighting of LEDs at low current.

손상된 제품은 누설전류의 증가, Turn on 전압의 저하, 저 전류에서의 점등불량 등의 이상 거동을 보일 수 있음.

## 15. Hazard Substance Analysis



**Test Report No.** F690501/LF-CTSAYAA08-08877

Issued Date: March 25, 2008      Page 1 of 3

To: SAMSUNG ELECTRO-MECHANICS CO., LTD.  
314, Maetan3-dong  
Yeongtong-gu  
Suwon-city  
KYUNGGI-DO 442-373  
Korea

The following merchandise was submitted and identified by the client as :

---

Product Name	: 5252 High Luminance White(2PD)
SGS File No.	: AYAA08-08877
Received Date	: March 19, 2008
Test Performing Date	: March 20, 2008
Test Performed	: SGS Testing Korea tested the sample(s) selected by applicant with following results
Test Results	: For further details, please refer to following page(s)
Comments	: The sampling and testing was performed only for the part indicated in the photo without disassembly by the applicant's specific request.

Pluto Kim  
Monet Jeong  
Billy Oh / Testing Person

SGS Testing Korea Co. Ltd.

A handwritten signature in black ink that reads "Jeff Jang". The signature is written in a cursive, flowing style with a large initial 'J'.

Jeff Jang / Chemical Lab Mgr

This document is issued by the Company under its General Conditions of Service printed, created or available on request and accessible at [http://www.sgs.com/conditions\\_and\\_terms.htm](#). Attention is drawn to the limitation of liability, indemnification and jurisdiction issues defined therein. Any holder of this document is advised that information contained herein reflects the Company's findings at the time of its intervention only and not the skills of Client's technicians, if any. The Company's sole responsibility is to its Client and this document does not constitute parties to a consultation firm exercising all their rights and obligations under the applicable documents. Any modification, alteration, forgery or falsification of the content or appearance of this document to mislead and/or otherwise may be prosecuted to the fullest extent of the law. Unless otherwise stated the results shown in this test report refer only to the sample(s) tested. This document cannot be reproduced except in full, without prior approval of the Company.

F052 Version2



Test Report No. F690501/LF-CTSAYAA08-08877

Issued Date: March 25, 2008

Page 2 of 3

Sample No. : AYAA08-08877.001

Sample Description : 5252 High Luminance White(2PD)

Item No./Part No. : 5252 High Luminance White(2PD)

#### Heavy Metals

Test Items	Unit	Test Method	MDL	Results
Cadmium (Cd)	mg/kg	US EPA 3052(1996), US EPA 6010B(1996), ICP	0.5	N.D.
Lead (Pb)	mg/kg	US EPA 3052(1996), US EPA 6010B(1996), ICP	5	N.D.
Mercury (Hg)	mg/kg	US EPA 3052(1996), US EPA 6010B(1996), ICP	2	N.D.
Hexavalent Chromium (Cr VI)	mg/kg	US EPA 3060A(1996), US EPA 7196A(1992), UV	1	N.D.

#### Flame Retardants-PBBs/PBDEs

Test Items	Unit	Test Method	MDL	Results
Monobromobiphenyl	mg/kg	US EPA 3540C, GC/MS	5	N.D.
Dibromobiphenyl	mg/kg	US EPA 3540C, GC/MS	5	N.D.
Tribromobiphenyl	mg/kg	US EPA 3540C, GC/MS	5	N.D.
Tetrabromobiphenyl	mg/kg	US EPA 3540C, GC/MS	5	N.D.
Pentabromobiphenyl	mg/kg	US EPA 3540C, GC/MS	5	N.D.
Hexabromobiphenyl	mg/kg	US EPA 3540C, GC/MS	5	N.D.
Heptabromobiphenyl	mg/kg	US EPA 3540C, GC/MS	5	N.D.
Octabromobiphenyl	mg/kg	US EPA 3540C, GC/MS	5	N.D.
Nonabromobiphenyl	mg/kg	US EPA 3540C, GC/MS	5	N.D.
Decabromobiphenyl	mg/kg	US EPA 3540C, GC/MS	5	N.D.
Monobromodiphenyl ether	mg/kg	US EPA 3540C, GC/MS	5	N.D.
Dibromodiphenyl ether	mg/kg	US EPA 3540C, GC/MS	5	N.D.
Tribromodiphenyl ether	mg/kg	US EPA 3540C, GC/MS	5	N.D.
Tetrabromodiphenyl ether	mg/kg	US EPA 3540C, GC/MS	5	N.D.
Pentabromodiphenyl ether	mg/kg	US EPA 3540C, GC/MS	5	N.D.
Hexabromodiphenyl ether	mg/kg	US EPA 3540C, GC/MS	5	N.D.
Heptabromodiphenyl ether	mg/kg	US EPA 3540C, GC/MS	5	N.D.
Octabromodiphenyl ether	mg/kg	US EPA 3540C, GC/MS	5	N.D.
Nonabromodiphenyl ether	mg/kg	US EPA 3540C, GC/MS	5	N.D.
Decabromodiphenyl ether	mg/kg	US EPA 3540C, GC/MS	5	N.D.

- NOTE: (1) N.D. = Not detected.(<MDL)  
(2) mg/kg = ppm  
(3) MDL = Method Detection Limit  
(4) - = No regulation  
(5) \*\* = Qualitative analysis (No Unit)  
(6) Negative = Undetectable / Positive = Detectable

This document is issued by the Company under its General Conditions of Service printed hereof or available on request and accessible at [www.sgs.com](http://www.sgs.com). Attention is drawn to the limitation of liability, indemnification and jurisdiction issues defined therein. Any holder of this document is advised that information contained herein reflects the Company's findings at the time of its intervention only and within the limits of Client's instructions, if any. The Company's sole responsibility is to its Client and this document does not constitute parties to a transaction from exercising all their rights and obligations under the transaction documents. Any unauthorized alteration, forgery or falsification of the content or appearance of this document is unlawful and offenders may be prosecuted to the fullest extent of the law. Unless otherwise stated the results shown in this file report refer only to the sample(s) tested. This document cannot be reproduced except in full, without prior approval of the Company.

F052 Version2



Sample No. : AYAA08-08877.001  
 Sample Description : 5252 High luminance White(2PD)  
 Item No./Part No. : 5252 High luminance White(2PD)

**Halogen Contents**

Test Items	Unit	Test Method	MDL	Results
Bromine(Br)	mg/kg	EN 14582:2007 , IC	30	N.D.
Chlorine(Cl)	mg/kg	EN 14582:2007 , IC	30	N.D.
Fluorine(F)	mg/kg	EN 14582:2007 , IC	30	N.D.
Iodine(I)	mg/kg	EN 14582:2007 , IC	30	N.D.

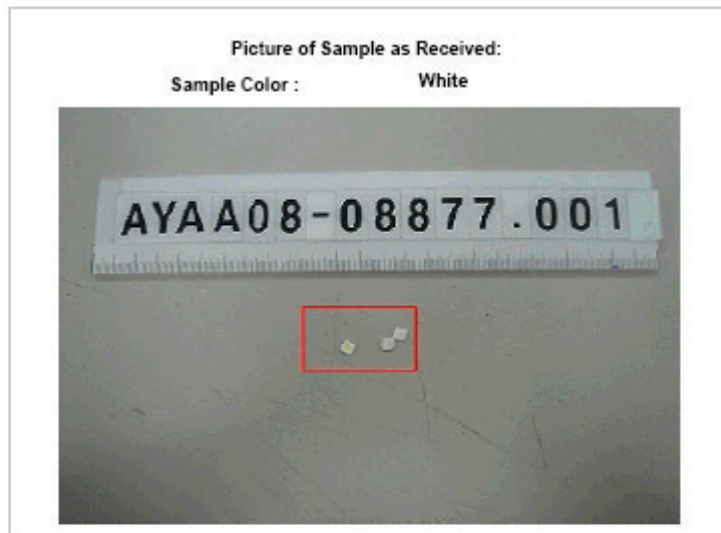

- NOTE:
- (1) N.D. = Not detected.(<MDL)
  - (2) mg/kg = ppm
  - (3) MDL = Method Detection Limit
  - (4) - = No regulation
  - (5) \*\* = Qualitative analysis (No Unit)
  - (6) Negative = Undetectable / Positive = Detectable

This document is issued by the Company under its General Conditions of Service printed herewith or available on request and accessible at [http://www.sgs.com/sgsweb/conditions\\_of\\_service.html](#). Attention is drawn to the limitation of liability, indemnification and jurisdiction issues defined therein. Any holder of this document is advised that information contained herein reflects the Company's findings at the time of its intervention only and within the limits of Client's instructions, if any. The Company's sole responsibility is to its Client and this document does not constitute parties to a transaction from exercising all their rights and obligations under the transaction documents. Any unauthorized alteration, forgery or falsification of the content or appearance of this document is unlawful and offenders may be prosecuted to the fullest extent of the law. Unless otherwise stated the results shown in this test report refer only to the sample(s) tested. This document cannot be reproduced except in full, without prior approval of the Company.

**Revision History**  
**(Model:SLTNCW2502AN)**

Date	Revision History	Writer	
		Drawn	Approved
2008.03.26	New Version	S.B. Yun	B.M. Kim
2008.04.10	오타 수정	S.B. Yun	B.M. Kim