

UM-1 FAMILY

STANDARD MONOLITHIC CRYSTAL FILTERS

STANDARD SPECIFICATIONS

Part No.	Nominal Frequency	Passband		Stopband		Attenuation Guaranteed		Ripple	Loss	Terminating Impedance	Operating Temperature	No. of Pole	Package
	f <sub>0</sub> (MHz)	min. (dB)	(KHz)	max. (dB)	(KHz)	min. (dB)	(KHz)	max. (dB)	max. (dB)	(Ω // pF)	(°C)		
21H7.5A(HJ)	21.4	3	±3.75	12	±12.5	60	-910	1.0	2.0	1000 // 5.5	-30 to +80	2	UM-1 / 8HJ
21H15A(HJ)	21.4	3	±7.5	20	±30.0	70	-910	1.0	2.0	1500 // 2.5	-30 to +80	2	UM-1 / 8HJ / 6HJ / 5HJ
21H30A(HJ)	21.4	3	±15.0	15	±45.0	60	-910	1.0	2.0	1500 // 1.0	-30 to +80	2	UM-1 / 8HJ
21H7.5B(HJ)	21.4	3	±3.75	40	±15.0	85	-910	1.0	4.0	850 // 5.0	-30 to +80	4	UM-1 / 8HJX2
21H15B(HJ)	21.4	3	±7.5	40	±25.0	90	-910	1.0	4.0	1500 // 2.0	-30 to +80	4	UM-1 / 8HJ / 6HJX2
21H30B(HJ)	21.4	3	±15.0	40	±50.0	85	-910	1.0	4.0	2000 // 0.5	-30 to +80	4	UM-1 / 8HJX2
45H7.5A(HJ)	45.0	3	±3.75	13	±12.5	75	-910	1.0	2.0	550 // 4.5	-30 to +80	2	UM-1 / 8HJ / 6HJ / 5HJ
45H15A(HJ)	45.0	3	±7.5	15	±25.0	75	-910	1.0	2.0	650 // 3.0	-30 to +80	2	UM-1 / 8HJ / 6HJ / 5HJ
45H20A(HJ)	45.0	3	±10.0	4	±20.0	65	-910	1.0	2.0	1000 // 0	-30 to +80	2	UM-1 / 8HJ / 6HJ / 5HJ
45H30A(HJ)	45.0	3	±15.0	15	±60.0	65	-910	1.0	2.0	1200 // 0	-30 to +80	2	UM-1 / 8HJ / 6HJ / 5HJ
45H7.5B(HJ)	45.0	3	±3.75	30	±12.5	90	-910	1.0	4.0	350 // 6.5	-30 to +80	4	UM-1 / 8HJ / 6HJ / 5HJX2
45H15B(HJ)	45.0	3	±7.5	30	±25.0	90	-910	1.0	4.0	650 // 3.0	-30 to +80	4	UM-1 / 8HJ / 6HJ / 5HJX2
45H20B(HJ)	45.0	3	±10.0	40	±40.0	90	-910	1.0	4.0	850 // 2.5	-30 to +80	4	UM-1 / 8HJ / 6HJ / 5HJX2
45H30B(HJ)	45.0	3	±15.0	35	±50.0	90	-910	1.0	4.0	1200 // 0.7	-30 to +80	4	UM-1 / 8HJ / 6HJ / 5HJX2

PACKAGE DATA

Item	Package	UM-1 / 8HJ	UM-1 / 6HJ	UM-1 / 5HJ
COVER		Metal	Metal	Metal
BASE		Metal	Metal	Metal
SEALING		Resistance weld	Resistance weld	Resistance weld
TERMINAL PLATING		Gold	Gold	Gold
METAL-JACKET PLATING		Gold(A) / Solder(B)	Gold(A) / Solder(B)	Gold(A) / Solder(B)

MCF

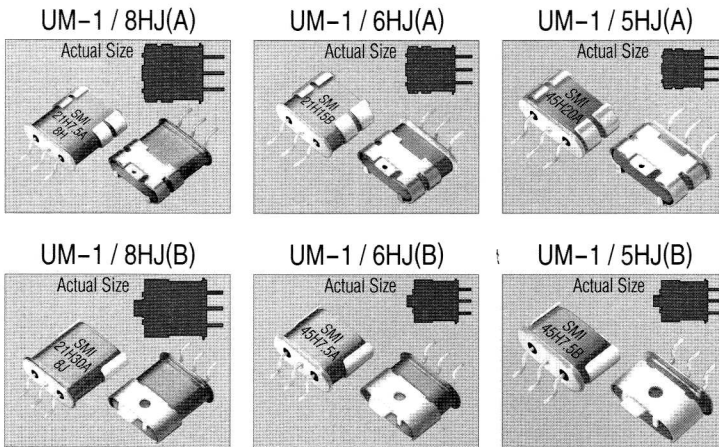

SOLDERING PATTERN for UM-1 / HJ(A)

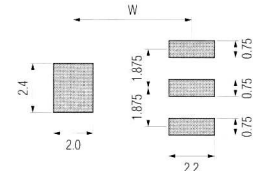

PACKAGE	W
UM-1 / 8HJ(A)	9.1
UM-1 / 6HJ(A)	7.0
UM-1 / 5HJ(A)	5.8

TAPE SPECIFICATIONS for UM-1 / 8HJ & UM-1 / 6HJ

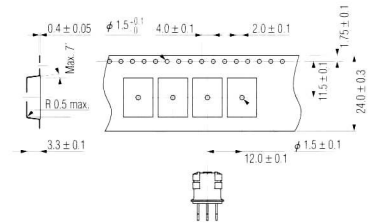

1000pcs. per reel (330mm dia.)

UM-1 / HJ(A)

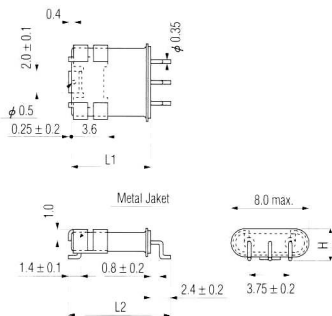

PACKAGE	L1	L2	H
UM-1 / 8HJ(A)	7.8±0.2	10.9MAX	3.0MAX
UM-1 / 6HJ(A)	5.7±0.2	8.8MAX	3.0MAX
UM-1 / 5HJ(A)	4.4±0.2	7.5MAX	3.0MAX

UM-1 / HJ(B)

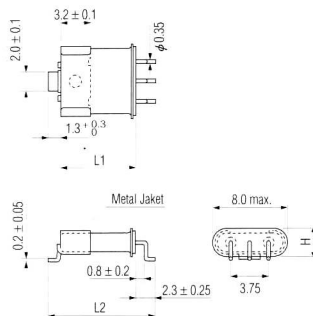

PACKAGE	L1	L2	H
UM-1 / 8HJ(B)	7.8±0.2	12.15MAX	3.0MAX
UM-1 / 6HJ(B)	5.8±0.2	10.15MAX	3.0MAX
UM-1 / 5HJ(B)	4.4±0.2	8.75MAX	3.0MAX

SOLDERING PATTERN for UM-1 / HJ(B)

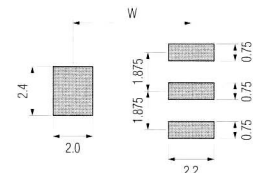

PACKAGE	W
UM-1 / 8HJ(B)	10.0
UM-1 / 6HJ(B)	8.0
UM-1 / 5HJ(B)	6.6

TAPE SPECIFICATIONS for UM-1 / 5HJ

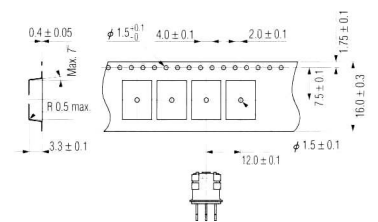

1000pcs. per reel (330mm dia.)