

μA776 Multi-Purpose Programmable Operational Amplifier

Linear Division Operational Amplifiers

Description

The μA776 Programmable Operational Amplifier is constructed using the Fairchild Planar Epitaxial process. High input impedance, low supply currents, and low input noise over a wide range of operating supply voltages coupled with programmable electrical characteristics result in an extremely versatile amplifier for use in high accuracy, low power consumption analog applications. Input noise voltage and current, power consumption, and input current can be optimized by a single resistor or current source that sets the chip quiescent current for nano watt power consumption or for characteristics similar to the μA741. Internal frequency compensation, absence of latch up, high slew rate and short circuit current protection assure ease of use in long time integrators, active filters, and sample and hold circuits.

- Micropower Consumption
- ± 1.2 V To ± 18 V Operation
- No Frequency Compensation Required
- Low Input Bias Currents
- Wide Programming Range
- High Slew Rate
- Low Noise
- Short Circuit Protection
- Offset Null Capability
- No Latch Up

Absolute Maximum Ratings

Storage Temperature Range

Metal Can	-65°C to +175°C
Molded DIP	-65°C to +150°C

Operating Temperature Range

Extended (μA776M)	-55°C to +125°C
Commercial (μA776C)	0°C to +70°C

Lead Temperature

Metal Can (soldering, 60 s)	300°C
Molded DIP (soldering, 10 s)	265°C

Internal Power Dissipation^{1, 2}

8L-Metal Can	1.00 W
8L-Molded DIP	0.93 W

Supply Voltage

± 18 V

Differential Input Voltage

± 30 V

Input Voltage³

± 15 V

Voltage Between Offset Null and V-

± 0.5 V

Output Short Circuit Duration⁴

Indefinite

I_{SET} (Maximum Current at I_{SET})

500 μA

V_{SET} (Maximum Voltage to

(V+ -2.0 V)

Ground at I_{SET}) ≤ V_{SET} ≤ V+

Notes

1. T_{J Max} = 150°C for the Molded DIP, and 175°C for the Metal Can.
2. Ratings apply to ambient temperature at 25°C. Above this temperature, derate the 8L-Metal Can at 6.7 mW/°C, and the 8L-Molded DIP at 7.5 mW/°C.
3. For supply voltages less than ± 15 V, the absolute maximum input voltage is equal to the supply voltage.
4. Short Circuit may be to ground or either supply. Rating applies to 125°C case temperature or 75°C ambient temperature for I_{SET} ≤ 30 μA.

Connection Diagram 8-Lead Metal Package (Top View)

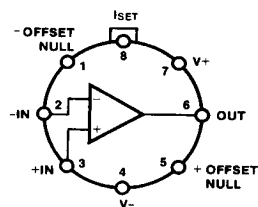

CD00631F

Lead 4 connected to case.

Order Information

Device Code	Package Code	Package Description
μA776HM	5W	Metal
μA776HC	5W	Metal

Connection Diagram 8-Lead DIP (Top View)

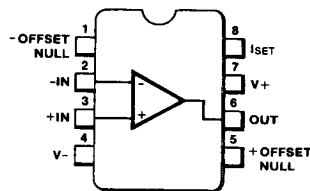

CD00641F

Order Information

Device Code	Package Code	Package Description
μA776TC	9T	Molded DIP

Equivalent Circuit

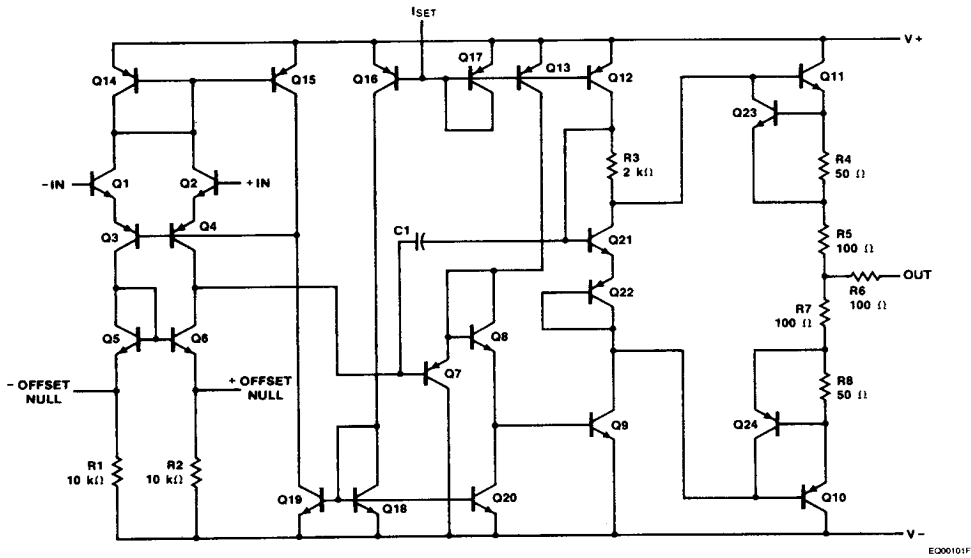

μA776

μA776

Electrical Characteristics $T_A = 25^\circ\text{C}$, $V_{CC} = \pm 15\text{ V}$, unless otherwise specified.

Symbol	Characteristic		Condition	$I_{SET} = 1.5\mu\text{A}$			$I_{SET} = 15\mu\text{A}$			Unit
				Min	Typ	Max	Min	Typ	Max	
V_{IO}	Input Offset Voltage		$R_S \leq 10\text{ k}\Omega$		2.0	5.0		2.0	5.0	mV
$V_{IO\text{ adj}}$	Input Offset Voltage Adjustment Range				9.0			18		mV
I_{IO}	Input Offset Current				0.7	3.0		2.0	15	nA
I_{IB}	Input Bias Current				2.0	7.5		15	50	nA
Z_I	Input Impedance				50			5.0		MΩ
I_{CC}	Supply Current				20	25		160	180	μA
P_c	Power Consumption					0.75			5.4	mW
I_{OS}	Output Short Circuit Current				3.0			12		mA
A_{VS}	Large Signal Voltage Gain		$V_O = \pm 10\text{ V}$, $R_L \geq 75\text{ k}\Omega$	200	400					V/mV
			$V_O = \pm 10\text{ V}$, $R_L \geq 5.0\text{ k}\Omega$				100	400		
V_{OP}	Output Voltage Swing		$R_L = 75\text{ k}\Omega$	± 12	± 14					V
			$R_L = 5.0\text{ k}\Omega$				± 10	± 13		
TR	Transient Response	Rise time	$V_I = 20\text{ mV}$, $R_L = 5.0\text{ k}\Omega$, $C_L = 100\text{ pF}$, $A_V = 1.0$		1.6			0.35		μs
		Overshoot			0			10		%
SR	Slew Rate		$R_L = 5.0\text{ k}\Omega$, $A_V = 1.0$		0.1			0.8		V/μs

The following specifications apply $-55^\circ\text{C} \leq T_A \leq +125^\circ\text{C}$

V_{IO}	Input Offset Voltage	$R_S \leq 10\text{ k}\Omega$			6.0			6.0	mV
I_{IO}	Input Offset Current	$T_A = +125^\circ\text{C}$			5.0			15	nA
		$T_A = -55^\circ\text{C}$			10			40	
I_{IB}	Input Bias Current	$T_A = +125^\circ\text{C}$			7.5			50	nA
		$T_A = -55^\circ\text{C}$			20			120	
I_{CC}	Supply Current				30			200	μA
P_c	Power Consumption				0.9			6.0	mW
CMR	Common Mode Rejection	$R_S \leq 10\text{ k}\Omega$	70	90		70	90		dB
V_{IR}	Input Voltage Range		± 10			± 10			V
PSRR	Power Supply Rejection Ratio	$R_S \leq 10\text{ k}\Omega$		25	150		25	150	μV/V
A_{VS}	Large Signal Voltage Gain	$V_O = \pm 10\text{ V}$, $R_L \geq 75\text{ k}\Omega$	100			75			V/mV
V_{OP}	Output Voltage Swing	$R_L = 75\text{ k}\Omega$	± 10			± 10			V

μA776

μA776

Electrical Characteristics $T_A = 25^\circ\text{C}$, $V_{CC} = \pm 3.0\text{ V}$, unless otherwise specified.

Symbol	Characteristic		Condition	$I_{SET} = 1.5\mu\text{A}$			$I_{SET} = 15\mu\text{A}$			Unit
				Min	Typ	Max	Min	Typ	Max	
V_{IO}	Input Offset Voltage		$R_S \leq 10\text{ k}\Omega$		2.0	5.0		2.0	5.0	mV
$V_{IO\text{ adj}}$	Input Offset Voltage Adjustment Range				9.0			18		mV
I_{IO}	Input Offset Current				0.7	3.0		2.0	15	nA
I_{IB}	Input Bias Current				2.0	7.5		15	50	nA
Z_I	Input Impedance				50			5.0		MΩ
I_{CC}	Supply Current				13	20		130	160	μA
P_c	Power Consumption				78	120		780	960	μW
I_{OS}	Output Short Circuit Current				3.0			5.0		mA
A_{VS}	Large Signal Voltage Gain		$V_O = \pm 1.0\text{ V}$, $R_L \geq 75\text{ k}\Omega$	50	200					V/mV
			$V_O = \pm 1.0\text{ V}$, $R_L \geq 5.0\text{ k}\Omega$				50	200		
TR	Transient Response	Rise time	$V_I = 20\text{ mV}$, $R_L = 5.0\text{ k}\Omega$, $C_L = 100\text{ pF}$, $A_V = 1.0$		3.0			0.6		μs
		Overshoot			0			5		%
SR	Slew Rate		$R_L = 5.0\text{ k}\Omega$, $A_V = 1.0$		0.03			0.35		V/μs

7

The following specifications apply $-55^\circ\text{C} \leq T_A \leq +125^\circ\text{C}$

V_{IO}	Input Offset Voltage	$R_S \leq 10\text{ k}\Omega$			6.0			6.0	mV
I_{IO}	Input Offset Current	$T_A = +125^\circ\text{C}$			5.0			15	nA
		$T_A = -55^\circ\text{C}$			10			40	nA
I_{IB}	Input Bias Current	$T_A = +125^\circ\text{C}$			7.5			50	nA
		$T_A = -55^\circ\text{C}$			20			120	nA
I_{CC}	Supply Current				25			180	μA
P_c	Power Consumption				150			1080	μW
CMR	Common Mode Rejection	$R_S \leq 10\text{ k}\Omega$	70	86		70	86		dB
V_{IR}	Input Voltage Range		± 1.0			± 1.0			V
PSRR	Power Supply Rejection Ratio	$R_S \leq 10\text{ k}\Omega$		25	150		25	150	μV/V
A_{VS}	Large Signal Voltage Gain	$V_O = \pm 1.0\text{ V}$, $R_L \geq 75\text{ k}\Omega$	25						V/mV
		$V_O = \pm 1.0\text{ V}$, $R_L \geq 5.0\text{ k}\Omega$				25			
V_{OP}	Output Voltage Swing	$R_L = 75\text{ k}\Omega$	± 2.0	± 2.4					V
		$R_L = 5.0\text{ k}\Omega$				± 1.9	± 2.1		

μA776

μA776C

Electrical Characteristics $T_A = 25^\circ\text{C}$, $V_{CC} = \pm 15\text{ V}$, unless otherwise specified.

Symbol	Characteristic	Condition	I _{SET} = 1.5μA			I _{SET} = 15μA			Unit
			Min	Typ	Max	Min	Typ	Max	
V _{IO}	Input Offset Voltage	R _S ≤ 10 kΩ		2.0	6.0		2.0	6.0	mV
V _{IO adj}	Input Offset Voltage Adjustment Range			9.0			18		mV
I _{IO}	Input Offset Current			0.7	6.0		2.0	25	nA
I _{IB}	Input Bias Current			2.0	10		15	50	nA
Z _I	Input Impedance			50			5.0		MΩ
I _{CC}	Supply Current			20	30		160	190	μA
P _c	Power Consumption				0.9			5.7	mW
I _{OS}	Output Short Circuit Current			3.0			12		mA
A _{VS}	Large Signal Voltage Gain	V _O = ± 10 V, R _L ≥ 75 kΩ	50	400					V/mV
		V _O = ± 10 V, R _L ≥ 5.0 kΩ				50	400		
V _{OP}	Output Voltage Swing	R _L = 75 kΩ	± 12	± 14					V
		R _L = 5.0 kΩ				± 10	± 13		
TR	Transient Response	Rise time Overshoot	V _I = 20 mV, R _L ≥ 5.0 kΩ, C _L = 100 pF, A _V = 1.0	1.6			0.35		μs
				0			10		%
SR	Slew Rate	R _L = 5.0 kΩ, A _V = 1.0		0.1			0.8		V/μs

The following specifications apply $0^\circ\text{C} \leq T_A \leq +70^\circ\text{C}$

V _{IO}	Input Offset Voltage	R _S ≤ 10 kΩ			7.5			7.5	mV
I _{IO}	Input Offset Current	T _A = 70°C			6.0			25	nA
		T _A = 0°C			10		40		
I _{IB}	Input Bias Current	T _A = 70°C			10			50	nA
		T _A = 0°C			20		100		
I _{CC}	Supply Current				35			200	μA
P _c	Power Consumption				1.05			6.0	mW
CMR	Common Mode Rejection	R _S ≤ 10 kΩ	70	90		70	90		dB
V _{IR}	Input Voltage Range		± 10			± 10			V
PSRR	Power Supply Rejection Ratio	R _S ≤ 10 kΩ		25	200		25	200	μV/V
A _{VS}	Large Signal Voltage Gain	V _O = ± 10 V, R _L ≥ 75 kΩ	50			50			V/mV
V _{OP}	Output Voltage Swing	R _L = 75 kΩ	± 10			± 10			V

μA776

μA776C

Electrical Characteristics $T_A = 25^\circ\text{C}$, $V_{CC} = \pm 3.0\text{ V}$, unless otherwise specified.

Symbol	Characteristic	Condition	I _{SET} = 1.5μA			I _{SET} = 15μA			Unit
			Min	Typ	Max	Min	Typ	Max	
V _{IO}	Input Offset Voltage	R _S ≤ 10 kΩ		2.0	6.0		2.0	6.0	mV
V _{IO adj}	Input Offset Voltage Adjustment Range			9.0			18		mV
I _{IO}	Input Offset Current			0.7	6.0		2.0	25	nA
I _{IB}	Input Bias Current			2.0	10		15	50	nA
Z _i	Input Impedance			50			5.0		MΩ
I _{CC}	Supply Current			13	20		130	170	μA
P _c	Power Consumption			78	120		780	1020	μW
I _{OS}	Output Short Circuit Current			3.0			5.0		mA
A _{VS}	Large Signal Voltage Gain	V _O = ±1.0 V, R _L ≥ 75 kΩ	25	200					V/mV
		V _O = ±1.0 V, R _L ≥ 5.0 kΩ				25	200		
TR	Transient Response	Rise time	V _I = 20 mV, R _L ≥ 5.0 kΩ, C _L = 100 pF, A _V = 1.0	3.0			0.6		μs
		Overshoot		0			5		%
SR	Slew Rate	R _L = 5.0 kΩ, A _V = 1.0		0.03			0.35		V/μs

The following specifications apply 0°C ≤ T_A ≤ +70°C

V _{IO}	Input Offset Voltage	R _S ≤ 10 kΩ			7.5			7.5	mV
I _{IO}	Input Offset Current	T _A = 70°C			6.0			25	nA
		T _A = 0°C			10			40	
I _{IB}	Input Bias Current	T _A = 70°C			10			50	nA
		T _A = 0°C			20			100	
I _{CC}	Supply Current				25			180	μA
P _c	Power Consumption				150			1080	μW
CMR	Common Mode Rejection	R _S ≤ 10 kΩ	70	86		70	86		dB
V _{IR}	Input Voltage Range		±1.0			±1.0			V
PSRR	Power Supply Rejection Ratio	R _S ≤ 10 kΩ		25	200		25	200	μV/V
A _{VS}	Large Signal Voltage Gain	V _O = ±1.0 V, R _L ≥ 75 kΩ	25						V/mV
		V _O = ±1.0 V, R _L ≥ 5.0 kΩ					25		
V _{OP}	Output Voltage Swing	R _L = 75 kΩ	±2.0	±2.4					V
		R _L = 5.0 kΩ					±2.0	±2.1	

Typical Performance Curves for $\mu A776$ and $\mu A776C$

Input Bias Current vs Set Current

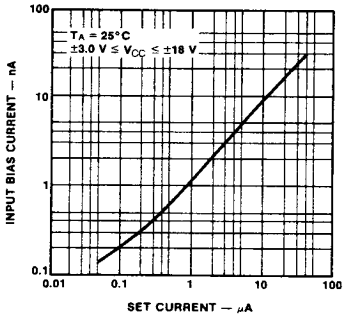

Input Bias Current vs Temperature

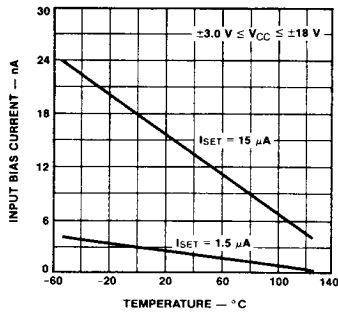

Input Offset Current vs Temperature

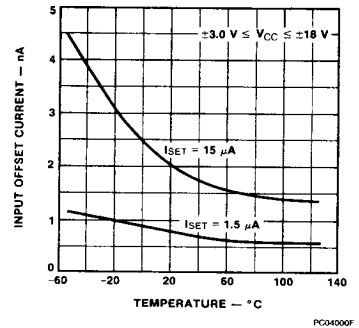

Change in Input Offset Voltage vs Set Current

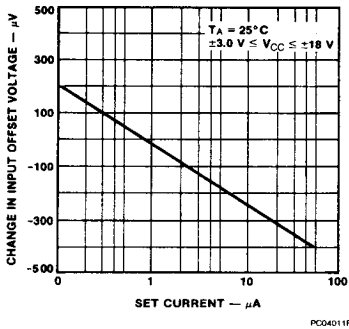

Change in Input Offset Voltage vs Temperature (Unnull)

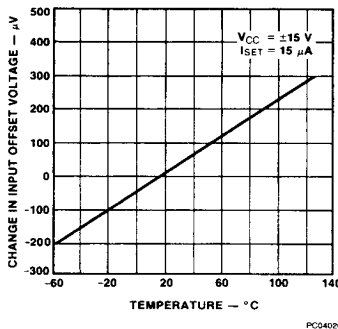

Input Noise Voltage vs Set Current

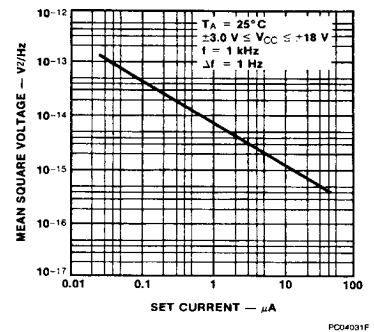

Input Noise Voltage and Current vs Frequency

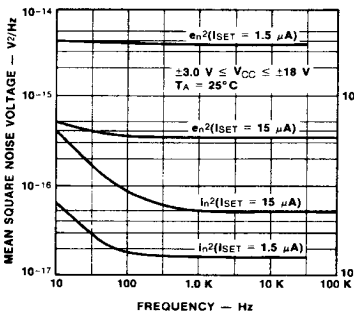

Input Noise Current vs Set Current

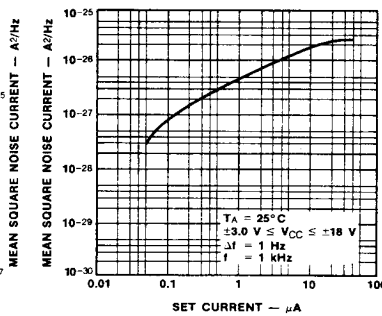

Optimum Source Resistor for Minimum Noise vs Set Current

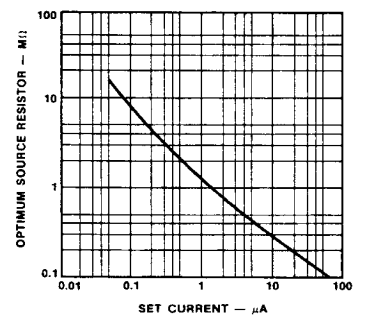

Typical Performance Curves for μ A776 and μ A776C (Cont.)

Output Voltage Swing vs Load Resistance

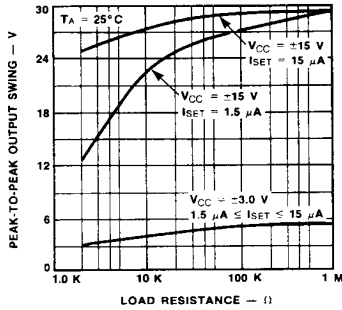

PC04071F

Output Voltage Swing vs Supply Voltage

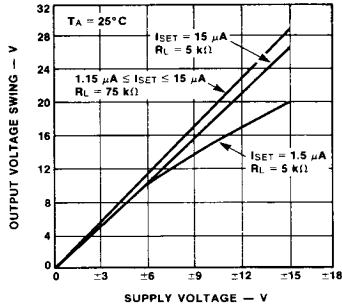

PC04080F

Gain Bandwidth Product vs Set Current

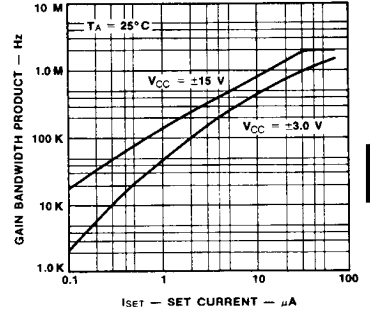

PC04091F

Voltage Gain vs Temperature

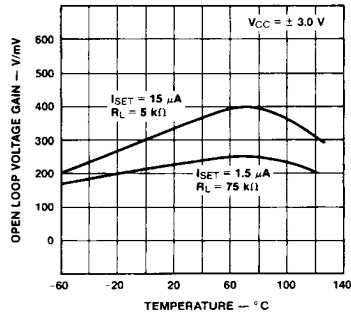

PC04101F

Voltage Gain vs Temperature

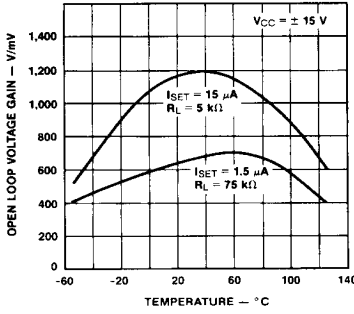

PC04111F

Power Supply Rejection Ratio vs Set Current

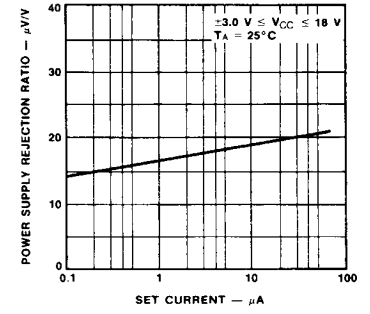

PC04121F

Supply Current vs Temperature

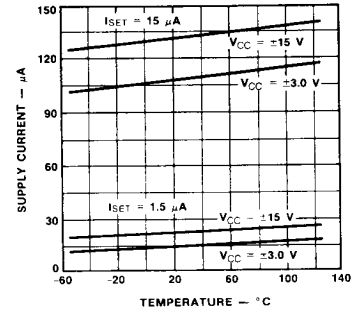

PC04130F

Standby Supply Current vs Set Current

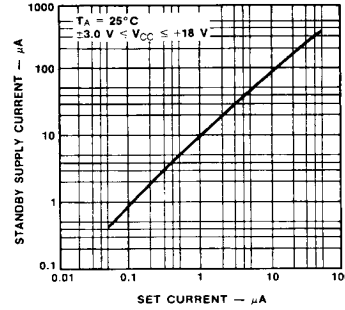

PC04141F

Thermal Response Of Input Offset Voltage To Step Change Of Case Temperature

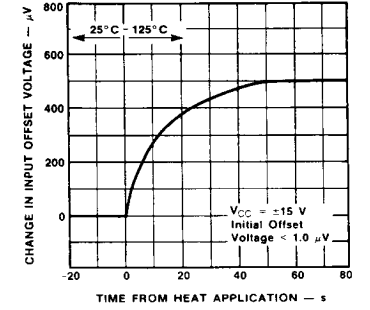

PC04151F

Typical Performance Curves for μA776 and μA776C (Cont.)

Stabilization Time Of Input Offset Voltage From Power On

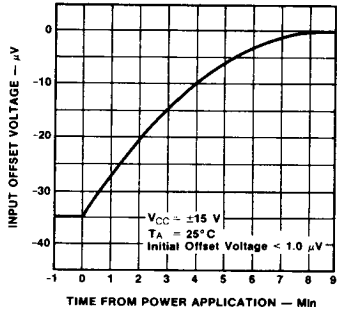

Input Offset Voltage Drift vs Time

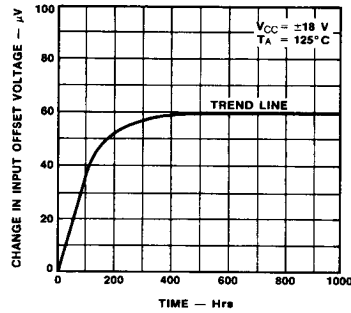

Slew Rate vs Set Current

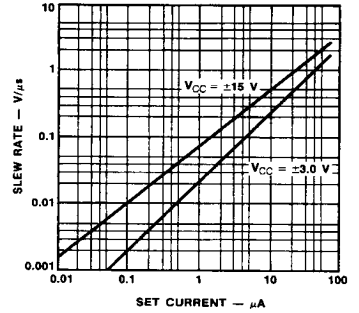

Voltage Follower Transient Response (Unity Gain)

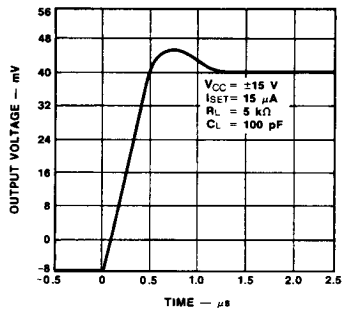

Set Current vs Set Resistor

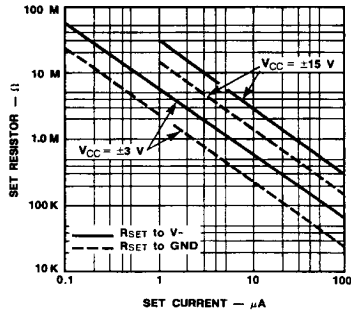

Quiescent Current Setting Resistor (ISET to V⁻)

V _S	I _{SET}	
	1.5 μA	15 μA
±1.5 V	1.7 MΩ	170 kΩ
±3.0 V	3.6 MΩ	360 kΩ
±6.0 V	7.5 MΩ	750 kΩ
±15 V	20 MΩ	2.0 MΩ

Note

The μA776 may be operated with R_{SET} connected to ground or V⁻.

I_{SET} Equations

$$I_{SET} = \frac{(V^+) - 0.7 - (V^-)}{R_{SET}}$$

where:

R_{SET} is connected to V⁻

$$I_{SET} = \frac{(V^+) - 0.7}{R_{SET}}$$

where:

R_{SET} is connected to ground.

Biasing Circuits

Resistor Biasing

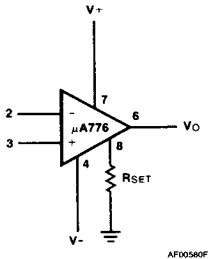

R_{SET} Connected to Ground

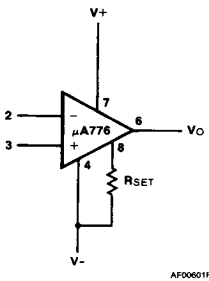

R_{SET} Connected to V^-
*Recommended for supply voltages less than ± 6 V.

Transistor Current Source Biasing

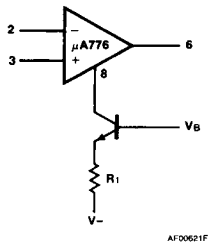

Voltage Offset Null Circuit

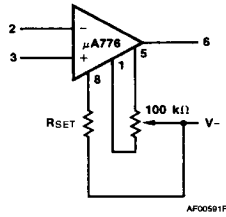

FET Current Source Biasing

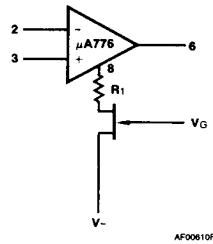

Transient Response Test Circuit

