



2.4GHz 802.11b Zero-IF Transceivers

General Description

The MAX2820/MAX2820A and MAX2821/MAX2821A single-chip zero-IF transceivers are designed for the 802.11b (11Mbps) applications operating in the 2.4GHz to 2.5GHz ISM band. The transceivers are nearly identical, except the MAX2821 and MAX2821A also provide a low-power shutdown mode and an analog voltage reference output. The MAX2820A/MAX2821A are cost-reduced versions, virtually identical in pinout and performance to the MAX2820/MAX2821. The transceivers include all the circuitry required to implement an 802.11b RF-to-baseband transceiver solution, providing a fully integrated receive path, transmit path, VCO, frequency synthesis, and baseband/control interface. Only a PA, RF switch, RF BPF, and a small number of passive components are needed to form the complete radio front-end solution.

The ICs eliminate the need for external IF and baseband filters by utilizing a direct-conversion radio architecture and monolithic baseband filters for both receiver and transmitter. They are specifically optimized for 802.11b (11Mbps CCK) applications. The baseband filtering and Rx and Tx signal paths support the CCK modulation scheme for BER = 10^{-5} at the required sensitivity levels.

The devices are suitable for the full range of 802.11b data rates (1Mbps, 2Mbps, 5.5Mbps, and 11Mbps) and also the higher-rate 22Mbps PBCC™ standard. The MAX2820 and MAX2821 are available in a 7mm × 7mm 48-lead QFN package. The MAX2820, MAX2821, MAX2820A, and MAX2821A are available in a 48-lead thin QFN package.

Applications

- 802.11b 11Mbps WLAN
- 802.11b+ 22Mbps PBCC High-Data-Rate WLAN
- 802.11a + b Dual-Band WLAN
- 2.4GHz ISM Band Radios

Features

- ◆ 2.4GHz to 2.5GHz ISM Band Operation
- ◆ 802.11b (11Mbps CCK and 22Mbps PBCC) PHY Compatible
- ◆ Complete RF-to-Baseband Transceiver
 - Direct-Conversion Upconverters and Downconverters
 - Monolithic Low-Phase-Noise VCO
 - Integrated Baseband Lowpass Filters
 - Integrated PLL with 3-Wire Serial Interface
 - Digital Bias Control for External PA
 - Transmit Power Control (Range > 25dB)
 - Receive Baseband AGC (Range > 65dB)
 - Complete Baseband Interface
 - Digital Tx/Rx Mode Control
 - Analog Receive Level Detection
- ◆ -97dBm Rx Sensitivity at 1Mbps
- ◆ -87dBm Rx Sensitivity at 11Mbps
- ◆ +2dBm Transmit Power (11Mbps CCK)
- ◆ Single +2.7V to +3.6V Supply
- ◆ Low-Current Shutdown Mode (MAX2821 only)
- ◆ Very Small 48-Pin QFN Package(s)

Ordering Information

PART	TEMP RANGE	PIN-PACKAGE
MAX2820 ETM-TD	-40°C to +85°C	48 Thin QFN
MAX2820ETM+TD	-40°C to +85°C	Lead Free
MAX2820A ETM-TD	-40°C to +85°C	48 Thin QFN
MAX2820AETM+TD	-40°C to +85°C	Lead Free
MAX2821 ETM-TD	-40°C to +85°C	48 Thin QFN
MAX2821ETM+TD	-40°C to +85°C	Lead Free
MAX2821A ETM-TD	-40°C to +85°C	48 Thin QFN
MAX2821AETM+TD	-40°C to +85°C	Lead Free

PBCC is a trademark of Texas Instruments, Inc.

Pin Configuration/Functional Diagram and Typical Application Circuit appear at end of data sheet.



2.4GHz 802.11b Zero-IF Transceivers

ABSOLUTE MAXIMUM RATINGS

V_{CC} Pins to GND-0.3V to +4.2V
 RF Inputs: RX_RFP, RX_RFN to GND-0.3V to (V_{CC} + 0.3V)
 RF Outputs: TX_RFP, TX_RFN to GND-0.3V to +4.2V
 Baseband Inputs: TX_BBIP, TX_BBIN, TX_BBQP,
 TX_BBQN to GND-0.3V to (V_{CC} + 0.3V)
 Baseband Outputs: RX_BBIP, RX_BBIN, RX_BBQP,
 RX_BBQN to GND-0.3V to (V_{CC} + 0.3V)
 Analog Inputs: RX_AGC, TX_GC, TUNE, ROSCN,
 ROSCP to GND-0.3V to (V_{CC} + 0.3V)
 Analog Outputs: PA_BIAS, CP_OUT, VREF
 to GND-0.3V to (V_{CC} + 0.3V)
 Digital Inputs: RX_ON, TX_ON, SHDNB, CSB, SCLK,

DIN, RF_GAIN, RX_1K to GND-0.3V to (V_{CC} + 0.3V)
 Bias Voltages: RBIAS, BYP+0.9V to +1.5V
 Short-Circuit Duration Digital Outputs: DOUT, RX_DET 10s
 RF Input Power: RX_RFN, RX_RFP+10dBm
 Continuous Power Dissipation (T_A = +70°C)
 48-Lead QFN (derate 27.0mW/°C above +70°C)2162mW
 48-Lead Thin QFN (derate 38.5mW/°C
 above +70°C)3077mW
 Operating Temperature Range-40°C to +85°C
 Junction Temperature+150°C
 Storage Temperature Range-65°C to +160°C
 Lead Temperature (soldering, 10s)+300°C

Stresses beyond those listed under "Absolute Maximum Ratings" may cause permanent damage to the device. These are stress ratings only, and functional operation of the device at these or any other conditions beyond those indicated in the operational sections of the specifications is not implied. Exposure to absolute maximum rating conditions for extended periods may affect device reliability.

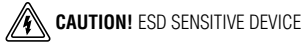

DC ELECTRICAL CHARACTERISTICS

(MAX2820/MAX2821 EV kit: V_{CC} = +2.7V to +3.6V, RF_GAIN = V_{IH}, 0V ≤ V_{TX_GC} ≤ +2.0V, 0V ≤ V_{RX_AGC} ≤ +2.0V, RBIAS = 12kΩ, no input signals at RF and baseband inputs, all RF inputs and outputs terminated into 50Ω, receiver baseband outputs are open, transmitter baseband inputs biased at +1.2V, registers set to default power-up settings, T_A = -40°C to +85°C, unless otherwise noted. Typical values are at V_{CC} = +2.7V, T_A = +25°C, unless otherwise noted.) (Note 1)

PARAMETERS	CONDITIONS	MIN	TYP	MAX	UNITS
Supply Voltage		2.7		3.6	V
Shutdown-Mode Supply Current (MAX2821 and MAX2821A)	SHDNB = V _{IL} , RX_ON = V _{IL} , TX_ON = V _{IL} T _A = -40°C to +85°C		2	50	μA
Standby-Mode Supply Current	SHDNB = V _{IH} , RX_ON = V _{IL} , TX_ON = V _{IL} T _A = +25°C		25	35	mA
	T _A = -40°C to +85°C			40	
Receive-Mode Supply Current	SHDNB = V _{IH} , RX_ON = V _{IH} , TX_ON = V _{IL} T _A = +25°C		80	100	mA
	T _A = -40°C to +85°C			110	
Transmit-Mode Supply Current	SHDNB = V _{IH} , RX_ON = V _{IL} , TX_ON = V _{IH} T _A = +25°C		70	85	mA
	T _A = -40°C to +85°C			90	
LOGIC INPUTS: SHDNB, RX_ON, TX_ON, SCLK, DIN, CSB, RF_GAIN					
Digital Input Voltage High (V _{IH})		V _{CC} - 0.5			V
Digital Input Voltage Low (V _{IL})				0.5	V
Digital Input Current High (I _{IH})		-5		+5	μA
Digital Input Current Low (I _{IL})		-5		+5	μA
LOGIC OUTPUTS: DOUT, RX_DET					
Digital Output Voltage High (V _{OH})	Sourcing 100μA	V _{CC} - 0.5			V
Digital Output Voltage Low (V _{OL})	Sinking 100μA			0.5	V
RX BASEBAND I/O					
RX_AGC Input Resistance	0V ≤ V _{RX_AGC} ≤ +2.0V		50		kΩ
RX I/Q Common-Mode Voltage			1.25		V
RX I/Q Output DC Offsets				15	mV
VOLTAGE REFERENCE (MAX2821/MAX2821A)					
Reference Voltage Output	T _A = -40°C to +85°C, I _{LOAD} = ±2mA	1.1	1.2	1.3	V
Output Impedance			25		Ω

2.4GHz 802.11b Zero-IF Transceivers

MAX2820/MAX2820A/MAX2821/MAX2821A

DC ELECTRICAL CHARACTERISTICS (continued)

(MAX2820/MAX2821 EV kit: $V_{CC} = +2.7V$ to $+3.6V$, $RF_GAIN = V_{IH}$, $0V \leq V_{TX_GC} \leq +2.0V$, $0V \leq V_{RX_AGC} \leq +2.0V$, $RBIAS = 12k\Omega$, no input signals at RF and baseband inputs, all RF inputs and outputs terminated into 50Ω , receiver baseband outputs are open, transmitter baseband inputs biased at $+1.2V$, registers set to default power-up settings, $T_A = -40^\circ C$ to $+85^\circ C$, unless otherwise noted. Typical values are at $V_{CC} = +2.7V$, $T_A = +25^\circ C$, unless otherwise noted.) (Note 1)

PARAMETERS	CONDITIONS	MIN	TYP	MAX	UNITS
TX BASEBAND I/O					
TX BB Input Common-Mode Range		1.0	1.2	1.4	V
TX BBI and BBQ Input Bias Current			-10		μA
TX BB Input Impedance	Differential resistance		100		$k\Omega$
TX_GC Input Bias Current	$0V \leq V_{TX_GC} \leq +2.0V$		10		μA
TX_GC Input Impedance	Resistance		250		$k\Omega$
REFERENCE OSCILLATOR INPUT					
Reference Oscillator Input Impedance			20		$k\Omega$

AC ELECTRICAL CHARACTERISTICS—RECEIVE MODE

(MAX2820/MAX2821 EV kit: $V_{CC} = +2.7V$ to $+3.6V$, f_{RF} and $f_{LO} = 2400MHz$ to $2499MHz$, $f_{OSC} = 22MHz$ or $44MHz$, receive baseband outputs = $500mV_{P-P}$, $SHDNB = RX_ON = V_{IH}$, $TX_ON = V_{IL}$, $CSB = V_{IH}$, $SCLK = DIN = V_{IL}$, $RF_GAIN = V_{IH}$, $0V \leq V_{RX_AGC} \leq +2.0V$, $RBIAS = 12k\Omega$, $I_{CP} = +2mA$, $BW_{PLL} = 45kHz$, differential RF input matched to 50Ω , registers set to default power-up settings, $T_A = +25^\circ C$, unless otherwise noted. Typical values are at $V_{CC} = +2.7V$, $f_{LO} = 2437MHz$, $f_{OSC} = 22MHz$, unless otherwise noted.) (Note 1)

PARAMETER	CONDITIONS	MIN	TYP	MAX	UNITS
RECEIVER CASCADE PERFORMANCE (RF INPUT TO BASEBAND OUTPUT)					
RF Frequency Range		2400		2499	MHz
LO Frequency Range		2400		2499	MHz
Voltage Gain (Note 2)	RF_GAIN = V_{IH} , V _{RX_AGC} = 0V	$T_A = +25^\circ C$	97	105	dB
		$T_A = -40^\circ C$ to $+85^\circ C$	95		
	RF_GAIN = V_{IH} , V _{RX_AGC} = +2.0V	$T_A = +25^\circ C$		33	
	RF_GAIN = V_{IL} , V _{RX_AGC} = 0V	$T_A = +25^\circ C$		75	
	RF_GAIN = V_{IL} , V _{RX_AGC} = +2.0V	$T_A = +25^\circ C$		2	
RF Gain Step	From RF_GAIN = V_{IH} to RF_GAIN = V_{IL}		30		dB
DSB Noise Figure (Note 3)	RF_GAIN = V_{IH} , RX gain $\geq 80dB$		3.5		dB
	RF_GAIN = V_{IH} , RX gain = 50dB		4.5		
	RF_GAIN = V_{IL} , RX gain = 50dB		34		
Adjacent Channel Rejection	RX gain = 70dB (Note 4)		49		dB
Input Third-Order Intercept Point (Note 5)	RF_GAIN = V_{IH} , RX gain = 80dB		-14		dBm
	RF_GAIN = V_{IL} , RX gain = 50dB		18		
Input Second-Order Intercept Point (Note 6)	RF_GAIN = V_{IH} , RX gain = 80dB		22		dBm
	RF_GAIN = V_{IL} , RX gain = 50dB		60		

2.4GHz 802.11b Zero-IF Transceivers

MAX2820/MAX2820A/MAX2821/MAX2821A

AC ELECTRICAL CHARACTERISTICS—RECEIVE MODE (continued)

(MAX2820/MAX2821 EV kit: $V_{CC} = +2.7V$ to $+3.6V$, f_{RF} and $f_{LO} = 2400MHz$ to $2499MHz$, $f_{OSC} = 22MHz$ or $44MHz$, receive baseband outputs = $500mV_{p-p}$, SHDNB = RX_ON = V_{IH} , TX_ON = V_{IL} , CSB = V_{IH} , SCLK = DIN = V_{IL} , RF_GAIN = V_{IH} , $0V \leq V_{RX_AGC} \leq +2.0V$, RBIAS = $12k\Omega$, $I_{CP} = +2mA$, $BW_{PLL} = 45kHz$, differential RF input matched to 50Ω , registers set to default power-up settings, $T_A = +25^\circ C$, unless otherwise noted. Typical values are at $V_{CC} = +2.7V$, $f_{LO} = 2437MHz$, $f_{OSC} = 22MHz$, unless otherwise noted.) (Note 1)

PARAMETER	CONDITIONS		MIN	TYP	MAX	UNITS
LO Leakage				-65		dBm
Input Return Loss	With external match			15		dB
RECEIVER BASEBAND						
BASEBAND FILTER RESPONSE						
-3dB Frequency	MAX2820/ MAX2821	Default bandwidth setting BW (2:0) = (010)		7		MHz
	MAX2820A/ MAX2821A			8		
Attenuation Relative to Passband	MAX2820/ MAX2821	At 12.5MHz		40		dB
		At 16MHz		65		
		At 20MHz		70		
		At 30MHz		85		
	MAX2820A/ MAX2821A	At 12.5MHz		28		
		At 16MHz		52		
BASEBAND OUTPUT CHARACTERISTICS						
RX I/Q Gain Imbalance			-1		+1	dB
RX I/Q Phase Quadrature Imbalance			-5		+5	Degrees
RX I/Q Output 1dB Compression	Differential voltage into $5k\Omega$			1		V _{p-p}
RX I/Q Output THD	$V_{OUT} = 500mV_{p-p}$ at 5.5MHz, $Z_L = 5k\Omega 5pF$			-35		dBc
BASEBAND AGC AMPLIFIER						
AGC Range	$V_{RX_AGC} = 0$ to $+2.0V$			70		dB
AGC Slope	Peak gain slope			60		dB/V
AGC Response Time	20dB gain step, 80dB to 60dB, settling to $\pm 1dB$			2		μs
BASEBAND RX PEAK LEVEL DETECTION (MAX2820/MAX2821 ONLY)						
RX Detector Trip Point (at RX_RF)	CW signal	RF_GAIN = V_{IH} , RX_DET = V_{OL} to V_{OH}		-49		dBm
		RF_GAIN = V_{IL} , RX_DET = V_{OH} to V_{OL}		-54		
RX Detector Hysteresis				5		dB
RX Detector Rise Time	With 3dB overdrive			1		μs

2.4GHz 802.11b Zero-IF Transceivers

MAX2820/MAX2820A/MAX2821/MAX2821A

AC ELECTRICAL CHARACTERISTICS—TRANSMIT MODE

(MAX2820/MAX2821 EV kit: $V_{CC} = +2.7V$ to $+3.6V$, f_{RF} and $f_{LO} = 2400MHz$ to $2499MHz$, $f_{OSC} = 22MHz$ or $44MHz$, transmit baseband inputs = $400mV_{p-p}$, $SHDNB = TX_ON = V_{IH}$, $RX_ON = V_{IL}$, $CSB = V_{IH}$, $0V \leq V_{TX_GC} \leq +2.0V$, $RBIAS = 12k\Omega$, $I_{CP} = +2mA$, $BW_{PLL} = 45kHz$, differential RF output matched to 50Ω through a balun, baseband input biased at $+1.2V$, registers set to default power-up settings, $T_A = +25^\circ C$, unless otherwise noted. Typical values are at $V_{CC} = +2.7V$, $f_{LO} = 2437MHz$, $f_{OSC} = 22MHz$, unless otherwise noted.)

PARAMETER	CONDITIONS		MIN	TYP	MAX	UNITS
TRANSMIT SIGNAL PATH: BASEBAND INPUT TO RF OUTPUT						
RF Output Frequency Range			2400		2499	MHz
LO Output Frequency Range			2400		2499	MHz
TX RF Output Power	$V_{IN} = 400mV_{p-p}$ at 5.5MHz, $V_{TX_GC} = 0V$, I/Q CW signal (Note 7)	$T_A = +25^\circ C$	-1	+3		dBm
		$T_A = -40^\circ C$ to $+85^\circ C$	-2			
TX RF ACPR (Note 8)	$-22MHz \leq f_{OFFSET} \leq -11MHz$, $11MHz \leq f_{OFFSET} \leq 22MHz$				-37	dBc
	$-33MHz \leq f_{OFFSET} < -22MHz$, $22MHz < f_{OFFSET} \leq 33MHz$				-59	
In-Band Spurious Signals Relative to Modulated Carrier	$f_{RF} = 2400MHz$ to 2483MHz	Unwanted sideband			-40	dBc
		LO signal			-30	
		Spurs $> \pm 22MHz$			-80	
TX RF Harmonics	$2 \times f_{LO}$				-40	dBm
	$3 \times f_{LO}$				-55	
TX RF Spurious Signal Emissions (Outside 2400MHz to 2483.5MHz) Nonharmonic Signals	$f_{RF} < 2400MHz$				-60	dBm
	$f_{RF} = 2500MHz$ to $3350MHz$				-43	
	$f_{RF} > 3350MHz$				-45	
TX RF Output Noise	$f_{OFFSET} \geq 22MHz$, $0V \leq V_{TX_GC} \leq +2.0V$				-135	dBm/Hz
TX RF Output Return Loss	With external match				15	dB
TX BASEBAND FILTER RESPONSE						
-3dB Frequency					10	MHz
Attenuation Relative to Passband	At 22MHz				25	dB
	At 44MHz				50	
TX GAIN-CONTROL CHARACTERISTICS						
Gain-Control Range	$0V \leq V_{TX_GC} \leq +2.0V$				30	dB
Gain-Control Slope	Peak gain slope				40	dB/V
Gain-Control Response Time	$V_{TX_GC} = +2.0V$ to $0V$ step				0.3	μs

2.4GHz 802.11b Zero-IF Transceivers

AC ELECTRICAL CHARACTERISTICS—PA BIAS

(MAX2820/MAX2821 EV kit: $V_{CC} = +2.7V$ to $+3.6V$, $SHDNB = V_{IH}$, $TX_ON = V_{IH}$, $CSB = V_{IH}$, PA_BIAS enabled, RBIAS = $12k\Omega$, registers set to default power-up settings, $T_A = +25^\circ C$, unless otherwise noted. Typical values are at $V_{CC} = +2.7V$, unless otherwise noted.)

PARAMETER	CONDITIONS	MIN	TYP	MAX	UNITS
Resolution			4		Bits
Full-Scale Output Current			300		μA
LSB Size			20		μA
Output Voltage Compliance Range	(Note 11)	1.0	1.2	1.3	V
Settling Time	Relative to rising edge of CSB, zero to full-scale step 0000 \rightarrow 1111, settle to 1/2 LSB, 2pF load		1		μs

AC ELECTRICAL CHARACTERISTICS—SYNTHESIZER

(MAX2820/MAX2821 EV kit: $V_{CC} = +2.7V$ to $+3.6V$, f_{RF} and $f_{LO} = 2400MHz$ to $2499MHz$, $f_{OSC} = 22MHz$ or $44MHz$, $SHDNB = V_{IH}$, $CSB = V_{IH}$, RBIAS = $12k\Omega$, $I_{CP} = +2mA$, $BW_{PLL} = 45kHz$, registers set to default power-up settings, $T_A = +25^\circ C$, unless otherwise noted. Typical values are at $V_{CC} = +2.7V$, $f_{LO} = 2437MHz$, $f_{OSC} = 22MHz$, unless otherwise noted.) (Note 11)

PARAMETER	CONDITIONS	MIN	TYP	MAX	UNITS
FREQUENCY SYNTHESIZER					
LO Frequency Range		2400		2499	MHz
Reference Frequency	$R(0) = 0$		22		MHz
	$R(0) = 1$		44		
Channel Spacing		1			MHz
Charge-Pump Output Current	MAX2820/MAX2821		± 1		mA
		ICP = 1	± 2		
	MAX2820A/MAX2821A		± 2		
Charge-Pump Compliance Range		0.4		$V_{CC} - 0.4$	V
Reference Spur Level (Note 10)	$-11MHz \leq f_{OFFSET} \leq 11MHz$		-41		dBc
	$-22MHz \leq f_{OFFSET} < -11MHz$, $11MHz < f_{OFFSET} \leq 22MHz$		-75		
	$f_{OFFSET} < -22MHz$, $f_{OFFSET} > 22MHz$		-90		
Closed-Loop Phase Noise	$f_{OFFSET} = 10kHz$		-80		dBc/Hz
	$f_{OFFSET} = 100kHz$		-87		
Closed-Loop Integrated Phase Noise	Noise integrated from 100Hz to 10MHz, measured at the TX_RF output		2.5		$^{\circ}RMS$
Reference Oscillator Input Level	AC-coupled sine wave input	200	600	1000	mV _{p-p}
VOLTAGE-CONTROLLED OSCILLATOR					
VCO Tuning Voltage Range		0.4		2.3	V
VCO Tuning Gain	$f_{LO} = 2400MHz$		170		MHz/V
	$f_{LO} = 2499MHz$		130		

2.4GHz 802.11b Zero-IF Transceivers

MAX2820/MAX2820A/MAX2821/MAX2821A

AC ELECTRICAL CHARACTERISTICS—SYSTEM TIMING

(MAX2820/MAX2821 EV kit: $V_{CC} = +2.7V$ to $+3.6V$, f_{RF} and $f_{LO} = 2400MHz$ to $2499MHz$, $f_{OSC} = 22MHz$ or $44MHz$, $SHDNB = V_{IH}$, $CSB = V_{IH}$, $RBIAS = 12k\Omega$, $I_{CP} = +2mA$, $BW_{LOOP} = 45kHz$, registers set to default power-up settings, $T_A = +25^\circ C$, unless otherwise noted. Typical values are at $V_{CC} = +2.7V$, $f_{LO} = 2437MHz$, $f_{OSC} = 22MHz$, unless otherwise noted.) (Note 11)

PARAMETER	CONDITIONS	MIN	TYP	MAX	UNITS
Channel-Switching Time	$f_{LO} = 2400MHz \leftrightarrow 2499MHz$, f_{LO} settles to $\pm 10kHz$ (Note 9)		150	200	μs
RX/TX Turnaround Time (Note 11)	RX to TX, output settles to within $\pm 2dB$ of final value of output power, relative to rising edge of TX_ON			3	μs
	TX to RX, output settles to within $\pm 2dB$ of final value of output power, relative to rising edge of RX_ON			5	
Standby-to-Transmit Mode	Standby to TX, output settles to within $\pm 2dB$ of final value of output power, relative to rising edge of TX_ON (Note 11)			3	μs
Standby-to-Receive Mode	Standby to RX, output settles to within $\pm 2dB$ of final value of output power, relative to rising edge of RX_ON (Note 11)			5	μs

AC ELECTRICAL CHARACTERISTICS—SERIAL INTERFACE TIMING

(MAX2820/MAX2821 EV kit: $V_{CC} = +2.7V$ to $+3.6V$, registers set to default power-up settings, $T_A = +25^\circ C$, unless otherwise noted.) (Note 11)

PARAMETER	CONDITIONS	MIN	TYP	MAX	UNITS
SERIAL INTERFACE TIMING (See Figure 1)					
t_{CSO}	SCLK rising edge to CSB falling edge wait time	5			ns
t_{CSS}	Falling edge of CSB to rising edge of first SCLK time	5			ns
t_{DS}	Data-to-serial clock setup time	5			ns
t_{DH}	Data-to-clock hold time	10			ns
t_{CH}	Serial clock pulse-width high	10			ns
t_{CL}	Clock pulse-width low	10			ns
t_{CSH}	Last SCLK rising edge to rising edge of CSB	5			ns
t_{CSW}	CSB high pulse width	10			ns
t_{CS1}	Time between the rising edge of CSB and the next rising edge of SCLK	5			ns
f_{CLK}	Clock frequency			50	MHz

- Note 1:** Parameters are production tested at $+25^\circ C$ only. Min/max limits over temperature are guaranteed by design and characterization.
- Note 2:** Defined as the baseband differential RMS output voltage divided by the RMS input voltage (at the RF balun input).
- Note 3:** Noise-figure specification excludes the loss of the external balun. The external balun loss is typically $\sim 0.5dB$.
- Note 4:** CCK interferer at 25MHz offset. Desired signal equals $-73dBm$. Interferer amplitude increases until baseband output from interferer is 10dB below desired signal. Adjacent channel rejection = $P_{interferer} - P_{desired}$.
- Note 5:** Measured at balun input. Two CW tones at $-43dBm$ with 15MHz and 25MHz spacing from the MAX2820/MAX2821 channel frequency. IP3 is computed from 5MHz IMD3 product measured at the RX I/Q output.
- Note 6:** Two CW interferers at $-38dBm$ with 24.5MHz and 25.5MHz spacing from the MAX2820/MAX2821 channel frequency. IP2 is computed from the 1MHz IMD2 product measured at the RX I/Q output.
- Note 7:** Output power measured after the matching and balun. TX gain is set to maximum.
- Note 8:** Adjacent and alternate channel power relative to the desired signal. TX gain is adjusted until the output power is $-1dBm$. Power measured with 100kHz video BW and 100kHz resolution BW.
- Note 9:** Time required to reprogram the PLL, change the operating channel, and wait for the operating channel center frequency to settle within $\pm 10kHz$ of the nominal (final) channel frequency.
- Note 10:** Relative amplitude of reference spurious products appearing in the TX RF output spectrum relative to a CW tone at 0.5MHz offset from the LO.
- Note 11:** Min/max limits are guaranteed by design and characterization.

2.4GHz 802.11b Zero-IF Transceivers

Typical Operating Characteristics

(MAX2820/MAX2821 EV kit, $V_{CC} = +2.7V$, $f_{BB} = 1MHz$, $f_{LO} = 2450MHz$, receive baseband outputs = 500mV_{P-P}, transmit baseband inputs = 400mV_{P-P}, $I_{CP} = +2mA$, $BW_{PLL} = 45kHz$, differential RF input/output matched to 50Ω through a balun, baseband input biased at +1.2V, registers set to default power-up settings, $T_A = +25^{\circ}C$, unless otherwise noted.)

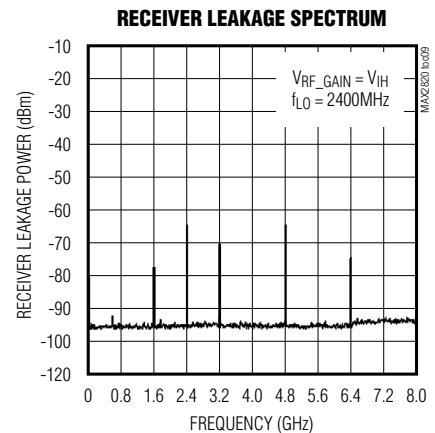
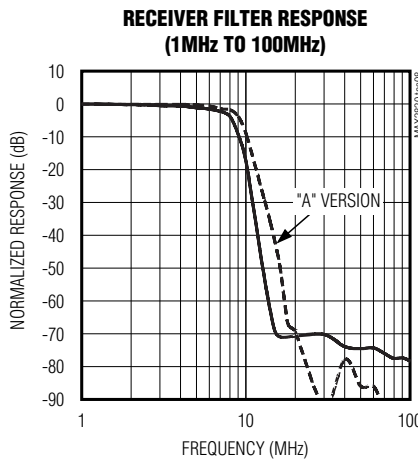
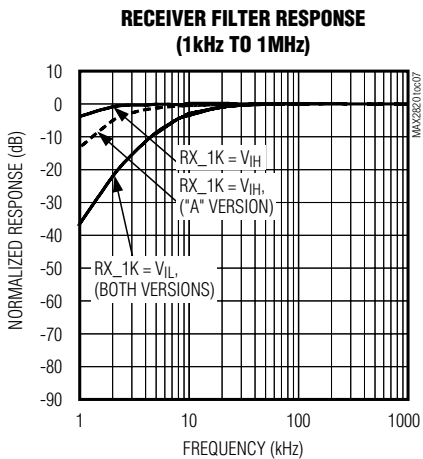
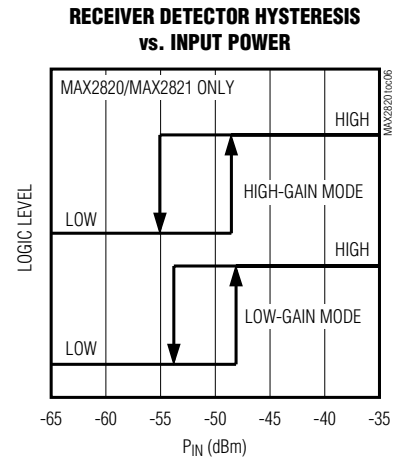
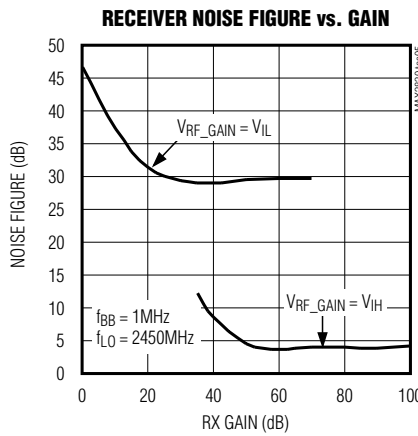
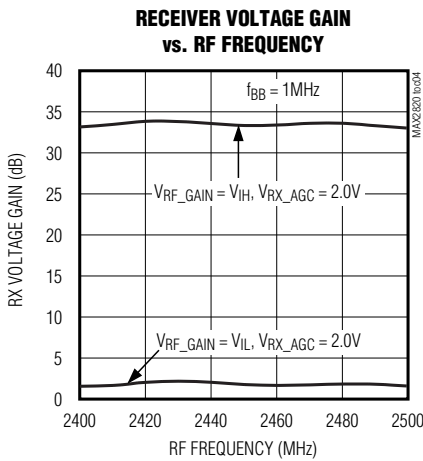
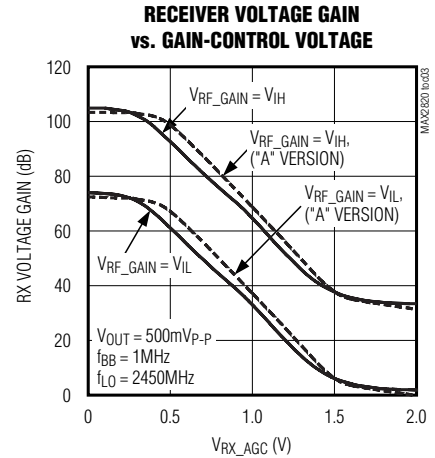
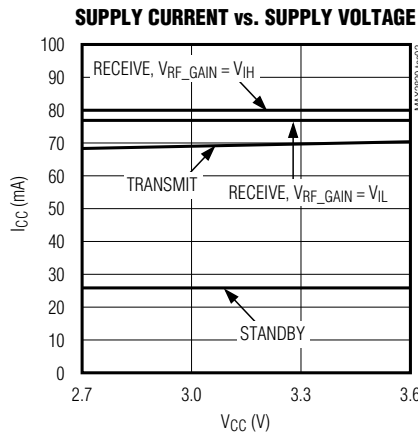
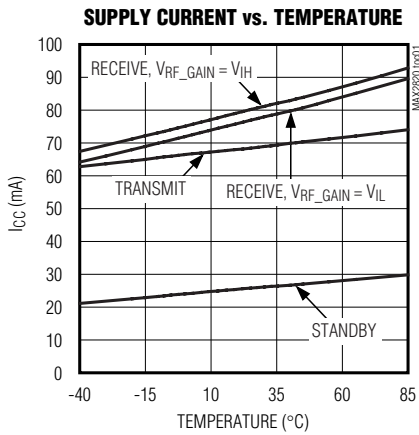

2.4GHz 802.11b Zero-IF Transceivers

Typical Operating Characteristics (continued)

(MAX2820/MAX2821 EV kit, $V_{CC} = +2.7V$, $f_{BB} = 1MHz$, $f_{LO} = 2450MHz$, receive baseband outputs = 500mVp-p, transmit baseband inputs = 400mVp-p, $I_{CP} = +2mA$, $BW_{PLL} = 45kHz$, differential RF input/output matched to 50Ω through a balun, baseband input biased at +1.2V, registers set to default power-up settings, $T_A = +25^\circ C$, unless otherwise noted.)

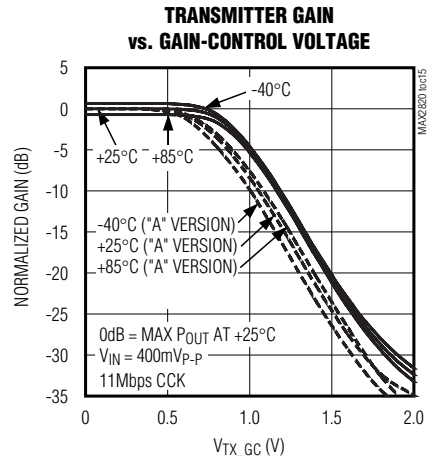
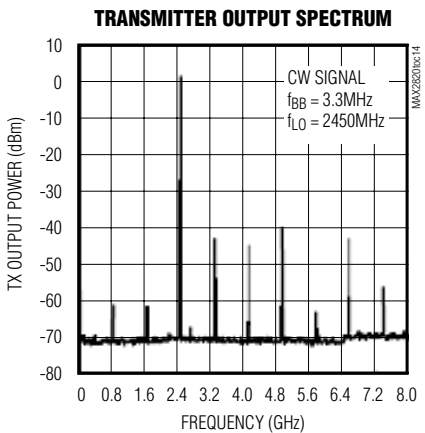
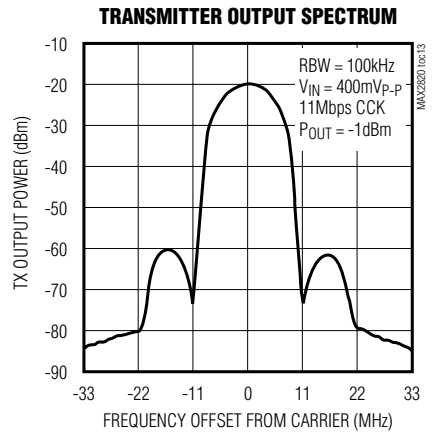
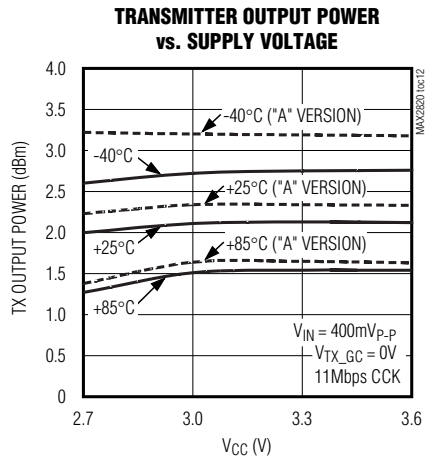
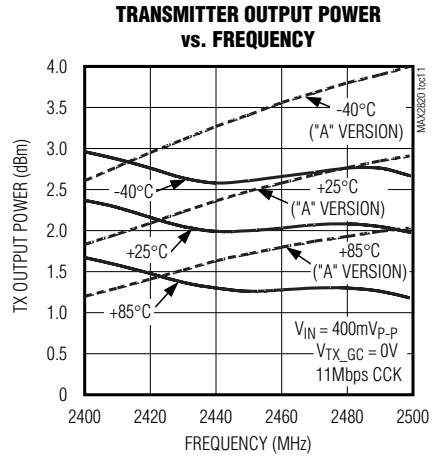
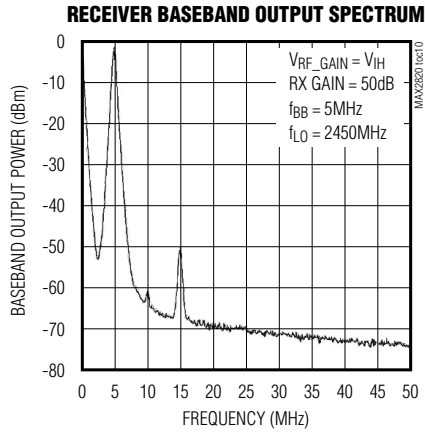

MAX2820/MAX2820A/MAX2821/MAX2821A

2.4GHz 802.11b Zero-IF Transceivers

Typical Operating Characteristics (continued)

(MAX2820/MAX2821 EV kit, $V_{CC} = +2.7V$, $f_{BB} = 1MHz$, $f_{LO} = 2450MHz$, receive baseband outputs = $500mV_{P-P}$, transmit baseband inputs = $400mV_{P-P}$, $I_{CP} = +2mA$, $BW_{PLL} = 45kHz$, differential RF input/output matched to 50Ω through a balun, baseband input biased at $+1.2V$, registers set to default power-up settings, $T_A = +25^\circ C$, unless otherwise noted.)

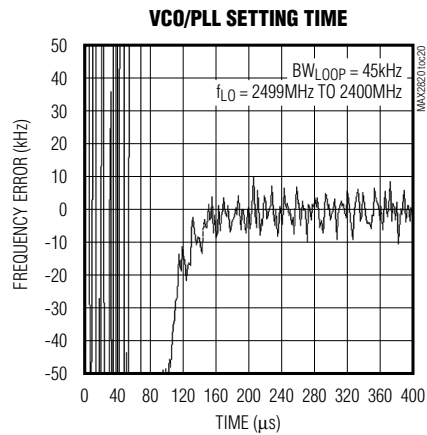
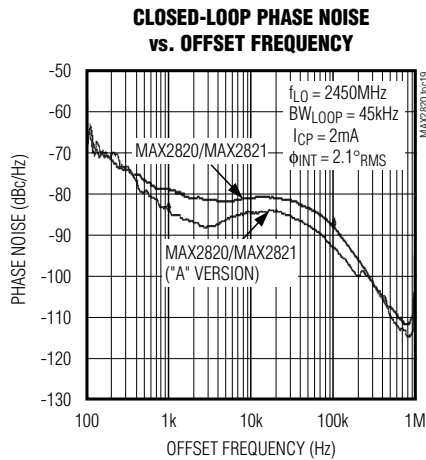
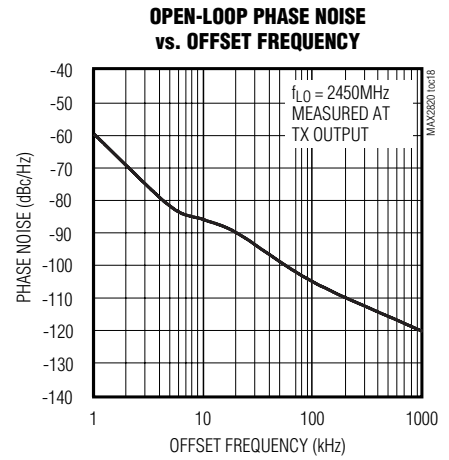
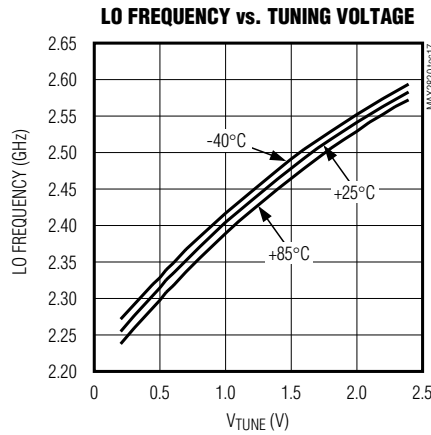
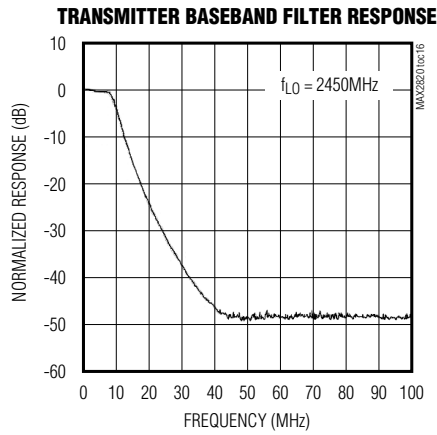

2.4GHz 802.11b Zero-IF Transceivers

Pin Configuration/Functional Diagram

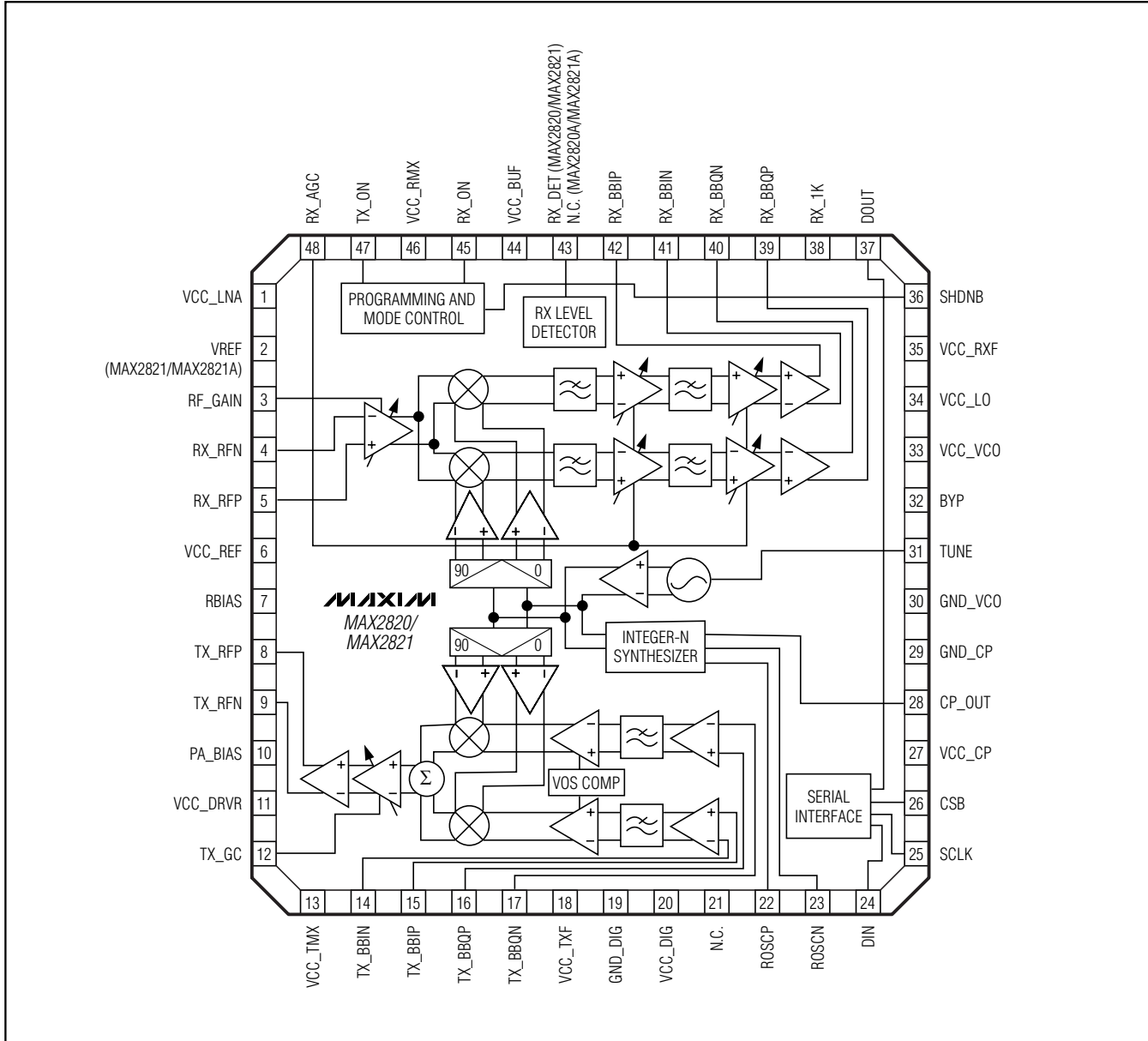

MAX2820/MAX2820A/MAX2821/MAX2821A

2.4GHz 802.11b Zero-IF Transceivers

Pin Description

PIN	NAME	DESCRIPTION
1	VCC_LNA	Supply Voltage for LNA. Bypass with a capacitor as close to the pin as possible. Do not share the bypass capacitor ground vias with other branches.
2	N.C.	No Connection. Not internally connected (MAX2820/MAX2820A only).
	VREF	Voltage Reference Output (MAX2821/MAX2821A only).
3	RF_GAIN	LNA Gain Select Logic Input. Logic high for LNA high-gain mode, logic low for LNA low-gain mode.
4	RX_RFN	Receiver LNA Negative Input. On-chip AC-coupling. Requires off-chip impedance match and connection to 2:1 balun.
5	RX_RFP	Receiver LNA Positive Input. On-chip AC-coupling. Requires off-chip impedance match and connection to 2:1 balun.
6	VCC_REF	Supply Voltage for Bias Circuitry and Autotuner. Bypass with a capacitor as close to the pin as possible. Do not share the bypass capacitor ground vias with other branches.
7	RBIAS	Precision Bias Resistor Pin. Connect a 12k Ω precision resistor ($\leq 2\%$) to GND.
8	TX_RFP	Transmit Driver Amplifier Positive Output. On-chip pullup choke to V _{CC} . Requires off-chip impedance match and connection to 4:1 balun.
9	TX_RFN	Transmit Driver Amplifier Negative Output. On-chip pullup choke to V _{CC} . Requires off-chip impedance match and connection to 4:1 balun.
10	PA_BIAS	Power-Amplifier Bias-Current Control Signal. Analog output. High-impedance, open-drain current source. Connect directly to bias-current control input on external PA.
11	VCC_DRVR	Supply Voltage for Transmit Driver. Bypass with a capacitor as close to the pin as possible. Do not share the bypass capacitor ground vias with other branches.
12	TX_GC	Transmit Gain-Control Input. Analog high-impedance input. Connect directly to baseband IC DAC output. See the <i>Typical Operating Characteristics</i> for Transmitter Gain vs. Gain-Control Voltage.
13	VCC_TMX	Supply Voltage for Transmit Mixer and VGA. Bypass with a capacitor as close to the pin as possible. Do not share the bypass capacitor ground vias with other branches.
14	TX_BBIN	Transmit Negative In-Phase Baseband Input. Analog high-impedance differential input. Connect directly to baseband IC DAC voltage output. Requires a 1.2V common-mode voltage.
15	TX_BBIP	Transmit Positive In-Phase Baseband Input. Analog high-impedance differential input. Connect directly to baseband IC DAC voltage output. Requires a 1.2V common-mode voltage.
16	TX_BBQP	Transmit Positive Quadrature Baseband Input. Analog high-impedance differential input. Connect directly to baseband IC DAC voltage output. Requires a 1.2V common-mode voltage.
17	TX_BBQN	Transmit Negative Quadrature Baseband Input. Analog high-impedance differential input. Connect directly to baseband IC DAC voltage output. Requires a 1.2V common-mode voltage.
18	VCC_TXF	Supply Voltage for Transmit Baseband Filter. Bypass with a capacitor as close to the pin as possible. Do not share the bypass capacitor ground vias with other branches.
19	GND_DIG	Digital Ground

2.4GHz 802.11b Zero-IF Transceivers

Pin Description (continued)

PIN	NAME	DESCRIPTION
20	VCC_DIG	Supply Voltage for Digital Circuitry. Bypass with a capacitor as close to the pin as possible. Do not share the bypass capacitor ground vias with other branches.
21	N.C.	No Connection. Not internally connected.
22	ROSCP	Reference Oscillator Positive Input. Analog high-impedance differential input. DC-coupled. Requires external AC-coupling. Connect an external reference oscillator to this analog input.
23	ROSCN	Reference Oscillator Negative Input. Analog high-impedance differential input. DC-coupled. Requires external AC-coupling. Bypass this analog input to ground with a capacitor for single-ended operation.
24	DIN	3-Wire Serial-Interface Data Input. Digital high-impedance input. Connect directly to baseband IC serial-interface CMOS output (SPI™/QSPI™/MICROWIRE™ compatible).
25	SCLK	3-Wire Serial-Interface Clock Input. Digital high-impedance input. Connect this digital input directly to baseband IC serial-interface CMOS output (SPI/QSPI/MICROWIRE compatible).
26	CSB	3-Wire Serial-Interface Enable Input. Digital high-impedance input. Connect directly to baseband IC serial-interface CMOS output (SPI/QSPI/MICROWIRE compatible).
27	VCC_CP	Supply Voltage for PLL Charge Pump. Bypass with a capacitor as close to the pin as possible. Do not share the bypass capacitor ground vias with other branches.
28	CP_OUT	PLL Charge-Pump Output. Analog high-impedance output. Current source. Connect directly to the PLL loop filter input.
29	GND_CP	PLL Charge-Pump Ground. Connect to PC board ground plane.
30	GND_VCO	VCO Ground. Connect to PC board ground plane.
31	TUNE	VCO Frequency Tuning Input. Analog high-impedance voltage input. Connect directly to the PLL loop filter output.
32	BYP	VCO Bias Bypass. Bypass with a 2000pF capacitor to ground.
33	VCC_VCO	Supply Voltage for VCO. Bypass with a capacitor as close to the pin as possible. Do not share the bypass capacitor ground vias with other branches. Important note: Operate from separate regulated supply voltage.
34	VCC_LO	Supply Voltage for VCO, LO Buffers, and LO Quadrature Circuitry. Bypass with a capacitor as close to the pin as possible. Do not share the bypass capacitor ground vias with other branches.
35	VCC_RXF	Supply Voltage for Receiver Baseband Filter. Bypass with a capacitor as close to the pin as possible. Do not share the bypass capacitor ground vias with other branches.
36	SHDNB	Active-Low Shutdown Input. Digital high-impedance CMOS input. Connect directly to baseband IC mode control CMOS output. Logic low to disable all device functions. Logic high to enable normal chip operation.
37	DOUT	Serial-Interface Data Output. Digital CMOS output. Optional connection.
38	RX_1K	Receiver 1kHz Highpass Bandwidth Control. Digital CMOS input. Connect directly to baseband IC CMOS output. Controls receiver baseband highpass -3dB corner frequency; logic low for 10kHz, logic high for 1kHz. See the <i>Applications Information</i> section for proper use of this function.

SPI and QSPI are trademarks of Motorola, Inc.
MICROWIRE is a trademark of National Semiconductor Corp.

2.4GHz 802.11b Zero-IF Transceivers

Pin Description (continued)

PIN	NAME	DESCRIPTION
39	RX_BBQP	Receive Positive Quadrature Baseband Output. Analog low-impedance differential buffer output. Connect output directly to baseband ADC input. Internally biased to 1.2V common-mode voltage and can drive loads up to 5k Ω 5pF.
40	RX_BBQN	Receive Negative Quadrature Baseband Output. Analog low-impedance differential buffer output. Connect output directly to baseband ADC input. Internally biased to 1.2V common-mode voltage and can drive loads up to 5k Ω 5pF.
41	RX_BBIN	Receive Negative In-Phase Baseband Output. Analog low-impedance differential buffer output. Connect output directly to baseband ADC input. Internally biased to 1.2V common-mode voltage and can drive loads up to 5k Ω 5pF.
42	RX_BBIP	Receive Positive In-Phase Baseband Output. Analog low-impedance differential buffer output. Connect output directly to baseband ADC input. Internally biased to 1.2V and can drive loads up to 5k Ω 5pF.
43	RX_DET	Receive Level Detection Output. Digital CMOS output. Connect output directly to baseband IC input. Used to indicate RF input level. Logic high for input levels above -49dBm (typ). Logic low for levels below -54dBm (typ). (MAX2820 and MAX2821)
	N.C.	No Connection (MAX2820A/MAX2821A)
44	VCC_BUF	Supply Voltage for Receiver Baseband Buffer. Bypass with a capacitor as close to the pin as possible. Do not share the bypass capacitor ground vias with other branches.
45	RX_ON	Receiver-On Control Input. Digital CMOS input. Connect to baseband IC mode control CMOS output.
46	VCC_RMX	Supply Voltage for Receiver Downconverter. Bypass with a capacitor as close to the pin as possible. Do not share the bypass capacitor ground vias with other branches.
47	TX_ON	Transmitter-On Control Input. Digital CMOS input. Connect directly to baseband IC mode control CMOS output.
48	RX_AGC	Receive AGC Control. Analog high-impedance input. Connect directly to baseband IC DAC voltage output. See the <i>Typical Operating Characteristics</i> for Gain vs. V _{RX_AGC} .
Exposed Paddle	GND	DC and AC Ground Return for IC. Connect to PC board ground plane using multiple vias.

Changes in “A” Version

The MAX2820A/MAX2821A are cost-reduced versions of the original MAX2820/MAX2821, intended as a drop-in replacement—no changes to PC board layout, BOM, or control software are required. Functionally, the “A” version removes unused functions and programmability while maintaining virtually identical performance characteristics. The changes are detailed below.

Synthesizer

The original device has the ability to program the charge-pump source/sink current ($\pm 1\text{mA}$ or $\pm 2\text{mA}$); the “A” version sets the charge-pump current at $\pm 2\text{mA}$, and bit SYNTH:D6 (ICP) should now always be programmed to be 1.

Receive Filter

The original device has the ability to control the baseband LPF corner; the “A” version sets the LPF corner at 8.0MHz. Register bits RECEIVE:D2–D0 are now “don’t cares.”

Receive-Level Detector (RSSI)

The original device has a receive-level detect output (pin 43, “RX_DET”); the “A” version removes this functionality. Pin 43 is a no-connect (N.C.) on the “A” version.

2.4GHz 802.11b Zero-IF Transceivers

MAX2820/MAX2820A/MAX2821/MAX2821A

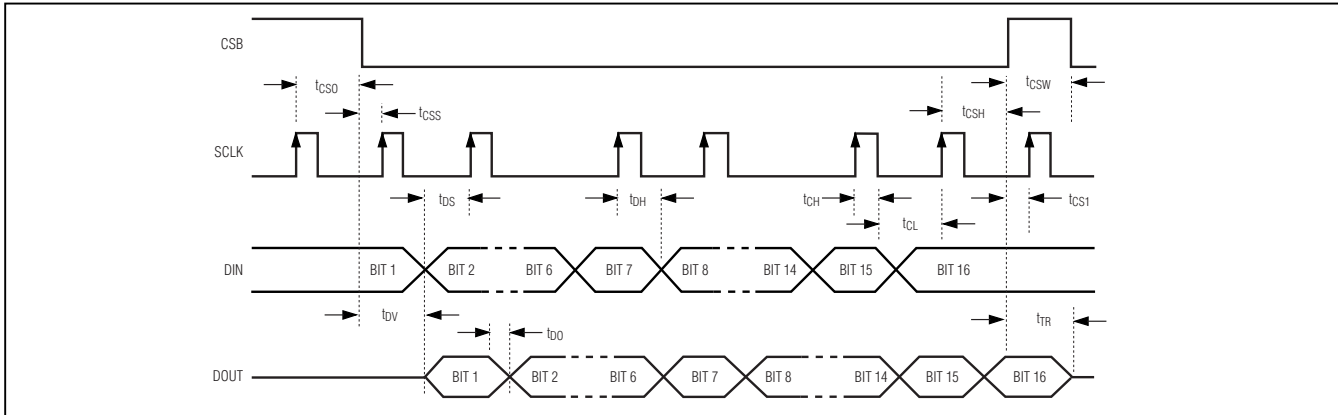

Figure 1. MAX2820/MAX2821 Serial-Interface Timing Diagram

Table 1. Operating-Mode Truth Table

OPERATING MODE	MODE CONTROL INPUTS			CIRCUIT BLOCK STATES		
	SHDNB	TX_ON	RX_ON	RX_PATH	TX_PATH	PLL/VCO/LO GEN.
Shutdown	0	X	X	OFF	OFF	OFF
Standby	1	0	0	OFF	OFF	ON
Receive	1	0	1	ON	OFF	ON
Transmit	1	1	0	OFF	ON	ON

Operating Modes

The MAX2820/MAX2821 have four primary modes of operation: shutdown, standby, receive active, and transmit active. The modes are controlled by the digital inputs SHDNB, TX_ON, and RX_ON. Table 1 shows the operating mode vs. the digital mode control input.

Shutdown Mode

Shutdown mode is achieved by driving SHDNB low. In shutdown mode, all circuit blocks are powered down, except for the serial interface circuitry. While the device is in shutdown, the serial interface registers can still be loaded by applying VCC to the digital supply voltage (VCC_DIG). All previously programmed register values are preserved during the shutdown mode, as long as VCC_DIG is applied.

Standby Mode

Standby mode is achieved by driving SHDNB high and RX_ON and TX_ON low. In standby mode, the PLL, VCO, LO generator, LO buffer, LO quadrature, and filter autotuner are powered on by default. The standby mode is intended to provide time for the slower-settling circuitry (PLL and autotuner) to turn on and settle to the correct frequency before making RX or TX active. The 3-wire serial interface is active and can load register

values at any time. Refer to the serial-interface specification for details.

Receive Mode

Receive mode is enabled by driving the digital inputs SHDNB high, RX_ON high, and TX_ON low. In receive mode, all receive circuit blocks are powered on and all VCO, PLL, and autotuner circuits are powered on. None of the transmit path blocks are active in this mode. Although the receiver blocks turn on quickly, the DC offset nulling requires ~10μs to settle. The receiver signal path is ready ~10μs after a low-to-high transition on RX_ON.

Transmit Mode

Transmit mode is achieved by driving the digital inputs SHDNB high, RX_ON low, and TX_ON high. In transmit mode, all transmit circuit blocks are powered on and all VCO, PLL, and autotuner circuits are powered on. None of the receive path blocks is active in this mode. Although the transmitter blocks turn on quickly, the baseband DC offset calibration requires ~2.2μs to complete. In addition, the TX driver amplifier is ramped from the low-gain state (minimum RF output) to high-gain state (peak RF output) over the next 1μs to 2μs. The transmit signal path is ready ~4μs after a low-to-high transition on TX_ON.

2.4GHz 802.11b Zero-IF Transceivers

Table 2. Programming Register Definition Summary (Address and Data)

REGISTER NAME	4 ADDRESS BITS				12 DATA BITS											
	A3	A2	A1	A0	D11	D10	D9	D8	D7	D6	D5	D4	D3	D2	D1	D0
	MSB	15	14	13	12	11	10	9	8	7	6	5	4	3	2	LSB
TEST	0	0	0	0	0	0	0	0	0	0	0	0	0	1	1	1
ENABLE	0	0	0	1	E11	E10	E9	E8	E7	E6	E5	E4	E3	E2	E1	E0
SYNTH	0	0	1	0	X	X	X	X	X	ICP	R5	R4	R3	R2	R1	R0
SYNTH ("A" VERSION)	0	0	1	0	X	X	X	X	X	X	R5	R4	R3	R2	R1	R0
CHANNEL	0	0	1	1	X	X	X	X	X	CF6	CF5	CF4	CF3	CF2	CF1	CF0
RECEIVE	0	1	0	0	2C2	2C1	2C0	1C2	1C1	1C0	DL1	DL0	SF	BW2	BW1	BW0
RECEIVE ("A" VERSION)	0	1	0	0	2C2	2C1	2C0	1C2	1C1	1C0	0	1	0	X	X	X
TRANSMIT	0	1	0	1	X	X	X	X	X	X	X	X	PA3	PA2	PA1	PA0

X = Don't care.

Programmable Registers

The MAX2820/MAX2820A and MAX2821/MAX2821A (the MAX2820 family) contain programmable registers to control various modes of operation for the major circuit blocks. The registers can be programmed through the 3-wire SPI/QSPI/MICROWIRE-compatible serial port. The MAX2820 family includes five programmable registers:

- 1) Test register (always program as in Table 2).
- 2) Block-enable register
- 3) Synthesizer register
- 4) Channel frequency register
- 5) Receiver settings register
- 6) Transmitter settings register

Each register consists of 16 bits. The four most significant bits (MSBs) are the register's address. The twelve least significant bits (LSBs) are used for register data. Table 2 summarizes the register configuration. A detailed description of each register is provided in Tables 3–6.

Data is shifted in the MSB first. The data sent to the transceiver, in 16-bit words, is framed by CSB. When CSB is low, the clock is active and data is shifted with the rising edge of the clock. When CSB transitions to high, the shift register is latched into the register selected by the contents of the address bits. Only the last 16 bits shifted into the device are retained in the shift register. No check is made on the number of clock pulses. Figure 1 documents the serial interface timing for the MAX2820 family.

Power-Up Default States

The devices provide power-up loading of default states for each of the registers. The states are loaded on a VCC_DIG supply voltage transition from 0V to VCC. The default values are retained until reprogrammed through the serial interface or the power supply voltage is taken to 0V. The default state of each register is described in Table 3. **Note:** Putting the IC in shutdown mode does not change the contents of the programming registers.

Block-Enable Register

The block-enable register permits individual control of the enable state for each major circuit block in the transceiver. The actual enable condition of the circuit block is a logical function of the block-enable bit setting and other control input states. Table 4 documents the logical definition of state for each major circuit block.

Synthesizer Register

The synthesizer register (SYNTH) controls the reference frequency divider and charge-pump current of the PLL. See Table 5 for a description of the bit settings.

Channel Frequency Register

The channel frequency register (CHANNEL) sets the RF carrier frequency for the radio. The channel is programmed as a number from 0 to 99. The actual frequency is 2400 + channel in MHz. The default setting is 37 for 2437MHz. See Table 6 for a description of the bit settings.

Receiver Settings Register (MAX2820/MAX2821 Only)

The receive settings register (RECEIVE) controls the receive filter -3dB corner frequency, RX level detector midpoint, and VGA DC offset nulling parameters. The defaults are intended to provide proper operation.

2.4GHz 802.11b Zero-IF Transceivers

MAX2820/MAX2820A/MAX2821/MAX2821A

Table 3. Register Power-Up Default States

REGISTER	ADDRESS	DEFAULT	FUNCTION
ENABLE	0001	000000011110	Block-Enable Control Settings (E)
SYNTH	0010	000001000000	Synthesizer Settings: <ul style="list-style-type: none"> • Reference frequency (R) • Lock-detect enable (LD) • Charge-pump current (ICP) (MAX2820/MAX2821 only)
CHANNEL	0011	000000100101	Channel frequency settings (CF)
RECEIVE	0100	111111010010	Receiver Settings: <ul style="list-style-type: none"> • VGA DC offset nulling parameter 1 (1C) • VGA DC offset nulling parameter 2 (2C) • -3dB lowpass filter bandwidth (BW) • Detector midpoint level (DL) • Special function bit (SF)
TRANSMIT	0101	000000000000	Transmit Settings: <ul style="list-style-type: none"> • PA bias (PA)

Table 4. Block-Enable Register (ENABLE)

ADDRESS	DATA BIT	CONTENT	DEFAULT	DESCRIPTION AND LOGICAL DEFINITION
0001	D11	E(11)	0	Reserved
	D10	E(10)	0	PA Bias-Control Enable (PAB_EN) • PAB_EN = SHDNB • (E(10) + TX_ON)
	D9	E(9)	0	Transmit Baseband Filters Enable (TXFLT_EN) • TXFLT_EN = SHDNB • (E(9) + TX_ON)
	D8	E(8)	0	TX Upconverter + VGA + Driver Amp Enable (TXUVD_EN) • TXUVD_EN = SHDNB • (E(8) + TX_ON)
	D7	E(7)	0	Receive Detector Enable (DET_EN) • DET_EN = SHDNB • (E(7) + RX_ON)
	D6	E(6)	0	RX Downconverter + Filters + AGC Amps Enable (RXDFA_EN) • RXDFA_EN = SHDNB • (E(6) + RX_ON)
	D5	E(5)	0	Receive LNA Enable (RXLNA_EN) • RXLNA_EN = SHDNB • (E(5) + RX_ON)
	D4	E(4)	1	Autotuner Enable (AT_EN) • AT_EN = SHDNB • (E(4) + RX_ON + TX_ON)
	D3	E(3)	1	PLL Charge-Pump Enable (CP_EN) • CP_EN = SHDNB • E(3)
	D2	E(2)	1	PLL Enable (PLL_EN) • PLL_EN = SHDNB • E(2)
	D1	E(1)	1	VCO Enable (VCO_EN) • VCO_EN = SHDNB • E(1)
	D0	E(0)	0	Reserved

2.4GHz 802.11b Zero-IF Transceivers

MAX2820/MAX2821/MAX2821A

Table 5. Synthesizer Register (SYNTH)

ADDRESS	DATA BIT	CONTENT	DEFAULT	DESCRIPTION
0010	D11:D7	X	00000	Reserved
	D6	ICP (MAX2820/ MAX2821)	1	Charge-Pump Current Select • 0 = ±1mA charge-pump current • 1 = ±2mA charge-pump current
		X (MAX2820A/ MAX2821A)	1	Reserved
	D5:D0	R(5:0)	000000	Reference Frequency Divider • 000000 = 22MHz • 000001 = 44MHz

Table 6. Channel Frequency Block Register (CHANNEL)

ADDRESS	DATA BIT	CONTENT	DEFAULT	DESCRIPTION
0011	D11:D7	X	00000	Reserved
	D6:D0	CF(6:0)	0100101	Channel Frequency Select: $f_{LO} = (2400 + CF(6:0))\text{MHz}$ • 0000000 = 2400MHz • 0000001 = 2401MHz • • 1100010 = 2498MHz • 1100011 = 2499MHz

Table 7a. Receive Settings Register (RECEIVE), (MAX2820/MAX2821 Only)

ADDRESS	DATA BIT	CONTENT	DEFAULT	DESCRIPTION
0100	D11:D9	2C(2:0)	111	VGA DC Offset Nulling Parameter 2
	D8:D6	1C(2:0)	111	VGA DC Offset Nulling Parameter 1
	D5:D4	DL(1:0)	01	RX Level Detector Midpoint Select • 11 = 01 = 50.2mVp • 10 = 70.9mVp • 00 = 35.5mVp
	D3	SF(0)	0	Special Function Select (not presently used) • 0 = OFF • 1 = ON
	D2:D0	BW(2:0)	010	Receive Filter -3dB Frequency Select (frequencies are approximate) • 000 = 8.5MHz • 001 = 8.0MHz • 010 = 7.5MHz • 011 = 7.0MHz • 100 = 6.5MHz • 101 = 6.0MHz

2.4GHz 802.11b Zero-IF Transceivers

Table 7b. Receive Settings Register (RECEIVE), (MAX2820A/MAX2821A Only)

ADDRESS	DATA BIT	CONTENT	DEFAULT	DESCRIPTION
0100	D11:D9	2C (2:0)	111	VGA DC Offset Nulling Parameter 2
	D8:D6	1C (2:0)	111	VGA DC Offset Nulling Parameter 1
	D5:D3	X	010	Reserved—Set to these Values
	D2:D0	X	010	Reserved—X = Don't Care. Rx filter is not programmable.

Table 8. Transmit Settings Register (TRANSMIT)

ADDRESS	DATA BIT	CONTENT	DEFAULT	DESCRIPTION
0101	D11:D4	X	X	Reserved
	D3:D0	PA(3:0)	0000	PA Bias Select: <ul style="list-style-type: none"> • 1111 = Highest PA bias • • 0000 = Lowest PA bias

However, the filter frequency and detector can be modified if desired. Do not reprogram VGA DC offset nulling parameters. These settings were optimized during development. See Table 7 for a description of the bit settings.

Transmitter Settings Register

The transmitter settings register (TRANSMIT) controls the 4-bit PA bias DAC. The 4 bits correspond to a PA bias current between 0 and full scale (~300 μ A). See Table 8 for the bit settings.

Applications Information

Receive Path

LNA

The RX_RF inputs are high-impedance RF differential inputs AC-coupled on-chip to the LNA. The LNA inputs require external impedance matching and differential to single-ended conversion. The balanced to single-ended conversion and interface to 50 Ω is achieved through the use of an off-chip 2:1 balun transformer, such as the small surface-mount baluns offered by Murata and TOKO. In the case of the 2:1 balun, the RX RF input must be impedance-matched to a differential/balanced impedance of 100 Ω . A simple LC network is sufficient to impedance-match the LNA to the balun. The *Typical Application Circuit* shows the balun, inductors, and capacitors that constitute the matching network. Refer to the MAX2820/MAX2821 EV kit schematic for component values of the matching network.

The line lengths and parasitics have a noticeable impact on the matching element values in the board-level circuit. Some empirical adjustment of LC component values is likely. Balanced line layout on the differential input traces is essential to maintaining good IP2 performance and RF common-mode noise rejection.

The receivers have two LNA gain modes that are digitally controlled by the logic signal applied to RF_GAIN. RF_GAIN high enables the high-gain mode, and RF_GAIN low enables the low-gain mode. The LNA gain step is nominally 30dB. In most applications, RF_GAIN is connected directly to a CMOS output of the baseband IC, and the baseband IC controls the state of the LNA gain based on the detected signal amplitude.

Receiver Baseband Lowpass Filtering

The on-chip receive lowpass filters provide the steep filtering necessary to attenuate the out-of-band (>11MHz) interfering signals to sufficiently low levels to preserve receiver sensitivity. The filter frequency response is precisely controlled on-chip and does not require user adjustment. In the MAX2820/MAX2821, a provision is made to permit the -3dB corner frequency and entire response to be slightly shifted up or down in frequency. This is intended to offer some flexibility in trading off adjacent channel rejection vs. passband distortion. The filter -3dB frequency is programmed through the serial interface. The specific bit setting vs. -3dB frequency is shown in Table 7. The typical receive baseband filter gain vs. frequency profile is shown in the *Typical Operating Characteristics*.

Receive Gain Control and DC Offset Nulling

The receive path gain is varied through an external voltage applied to the pin RX_AGC. Maximum gain is at $V_{RX_AGC} = 0V$ and minimum gain is at $V_{RX_AGC} = 2V$. The RX_AGC input is a high-impedance analog input designed for direct connection to the RX_AGC DAC output of the baseband IC. The gain-control range, which is continuously variable, is typically 70dB. The gain-control characteristic is shown in the *Typical*

2.4GHz 802.11b Zero-IF Transceivers

Operating Characteristics section graph Receiver Voltage Gain vs. Gain-Control Voltage.

Some local noise filtering through a simple RC network at the input is permissible. However, the time constant of this network should be kept sufficiently low in order not to limit the desired response time of the RX gain-control function.

Receiver Baseband Amplifier Outputs

The receiver baseband outputs (RX_BBIP, RX_BBIN, RX_BBQP, and RX_BBQN) are differential low-impedance buffer outputs. The outputs are designed to be directly connected (DC-coupled) to the in-phase (I) and quadrature-phase (Q) ADC inputs of the baseband IC. The RX I/Q outputs are internally biased to +1.2V common-mode voltage. The outputs are capable of driving loads up to 5k Ω || 5pF with the full bandwidth baseband signals at a differential amplitude of 500mV_{p-p}.

Proper board layout is essential to maintain good balance between I/Q traces. This provides good quadrature phase accuracy.

Receiver Power Detector (MAX2820/MAX2821 Only)

The receiver level detector is a digital output from an internal threshold detector that is used to determine when to change the LNA gain state. In most applications, it is connected directly to a comparator input of the baseband IC. The threshold level can be programmed through the MAX2820/MAX2821 control software.

Transmit Path

Transmitter Baseband Inputs

The transmitter baseband inputs (TX_BBIP, TX_BBIN, TX_BBQP, and TX_BBQN) are high-impedance differential analog inputs. The inputs are designed to be directly connected (DC-coupled) to the in-phase (I) and quadrature-phase (Q) DAC outputs of the baseband IC. The inputs must be externally biased to +1.2V common-mode voltage. Typically, the DAC outputs are current outputs with external resistor loads to ground. I and Q are nominally driven by a 400mV_{p-p} differential baseband signal.

Proper board layout is essential to maintain good balance between I/Q traces. This provides good quadrature phase accuracy by maintaining equal parasitic capacitance on the lines. In addition, it is important not to expose the TX I/Q circuit board traces going from the digital baseband IC to the TX_BB inputs. The lines should be shielded on an inner layer to prevent coupling of RF to these TX I/Q inputs and possible envelope demodulation of the RF signal.

Transmit Path Baseband Lowpass Filtering

The on-chip transmit lowpass filters provide the filtering necessary to attenuate the unwanted higher-frequency spurious signal content that arises from the DAC clock feedthrough and sampling images. In addition, the filter provides additional attenuation of the second sidelobe of signal spectrum. The filter frequency response is set on-chip. No user adjustment or programming is required. The Typical Gain vs. Frequency profile is shown in the *Typical Operating Characteristics*.

Transmitter DC Offset Calibration

In a zero-IF system, in order to achieve low LO leakage at the RF output, the DC offset of the TX baseband signal path must be reduced to as near zero as possible. Given that the amplifier stages, baseband filters, and TX DAC possesses some finite DC offset that is too large for the required LO leakage specification, it is necessary to “null” the DC offset. The MAX2820 family accomplishes this through an on-chip calibration sequence. During this sequence, the net TX baseband signal path offsets are sampled and cancelled in the baseband amplifiers. This calibration occurs in the first ~2.2 μ s after TX_ON is taken high. During this time, it is essential that the TX DAC output is in the 0V differential state. The calibration corrects for any DAC offset. However, if the DAC is set to a value other than the 0V state, then an offset is erroneously sampled by the TX offset calibration. The TX DAC output must be put into the 0V differential state at or before the time TX_ON is taken high.

Power-Amplifier Driver Output

The TX_RF outputs are high-impedance RF differential outputs directly connected to the driver amplifier. The outputs are essentially open-collector outputs with an on-chip inductor choke connected to VCC_DRVR. The power-amplifier driver outputs require external impedance matching and differential to single-ended conversion. The balanced to single-ended conversion and interface to 50 Ω is achieved through the use of an off-chip 4:1 balun transformer, such as one from Murata or TOKO. In this case, the TX RF output must be impedance-matched to a differential/balanced impedance of 200 Ω . The *Typical Application Circuit* shows the balun, inductors, and capacitors that constitute the matching network of the power amplifier driver outputs. The output match should be adjusted until the return loss at the balun output is >10dB.

2.4GHz 802.11b Zero-IF Transceivers

Transmit Gain Control

The transmit gain-control input provides a direct analog control over the transmit path gain. The transmit gain is controlled by an external voltage at pin TX_GC. The typical gain-control characteristic is provided in the *Typical Operating Characteristics* graph Transmitter Gain Control vs. Gain-Control Voltage. The input is a high-impedance analog input designed to directly connect to the DAC output of the baseband IC. Some local noise filtering through a simple RC network at the input is permissible. However, the time constant of this network should be kept sufficiently low so the desired response time of the TX gain-control function is not limited.

During the TX turn-on sequence, the gain is internally set at the minimum while the TX baseband offset calibration is taking place. The RF output is effectively “blanked” for the first 2.2 μ s after TX_ON is taken high. After 2.2 μ s, the “blanking” is released, and the gain-control amplifier ramps to the gain set by the external voltage applied to the TX_GC input.

PA Bias DAC Output

The MAX2820 family provides a programmable analog current source output for use in biasing the RF power amplifier, such as the MAX2242. The output is essentially an open-drain output of a current source DAC. The output is designed to directly connect to the bias-current pin on the power amplifier. The value of the current is determined by the 4 bits programmed into transmit (D3:D0). This programmability permits optimizing of the power-amplifier idle current based on the output power level of the PA. Care must be taken in the layout of this line. Avoid running the line in parallel with the RF line. RF might couple onto the line, given the high impedance of the output. This might result in rectified RF, altering the value of the bias current and causing erratic PA operation.

Synthesizer

Channel Frequency and Reference Frequency

The synthesizer/PLL channel frequency and reference settings establish the divider/counter settings in the integer-N synthesizer. Both the channel frequency and reference oscillator frequency are programmable through the serial interface. The channel frequency is programmed as a channel number 0 to 99 to set the carrier frequency to 2400MHz to 2499MHz (LO frequency = channel + 2400). The reference frequency is programmable to 22MHz or 44MHz. These settings are intend-

ed to cover only the required 802.11b channel spacing and the two possible crystal oscillator options used in the radios.

Reference Oscillator Input

The reference oscillator inputs ROSCP and ROSCN are high-impedance analog inputs. They are designed to be connected to the reference oscillator output through a coupling capacitor. The input amplitude can range from 200mV_{P-P} to 1000mV_{P-P}; therefore, in the case of a reference oscillator with a CMOS output, the signal must be attenuated before being applied to the ROSC inputs. The signal can be attenuated with a resistor- or capacitor-divider network.

Reference Voltage Output

A voltage reference output is provided on the MAX2821/MAX2821A from pin 2, VREF, for use with certain baseband ICs. The nominal output voltage is 1.2V. The reference voltage is first-order compensated over temperature to provide a reasonably low drift output, 1.1V to 1.3V over temperature, under load conditions. The output stage is designed to drive 2mA loads with up to 20pF of load capacitance. The VREF output is designed to directly connect to the baseband reference input.

Loop Filter

The PLL uses a classical charge pump into an external loop filter (C-RC) in which the filter output connects to the voltage tuning input of the VCO. This simple third-order lowpass loop filter closes the loop around the synthesizer. The *Typical Application Circuit* shows the loop filter elements around the transceiver. The capacitor and resistor values are set to provide the loop bandwidth required to achieve the desired lock time while also maintaining loop stability. Refer to the MAX2820/MAX2821 EV kit schematic for component values. A 45kHz loop bandwidth is recommended to ensure that the loop settles quickly enough to achieve 5 μ s TX turnaround time and 10 μ s RX turnaround time. This is the loop filter on the EV kit. Narrowing the loop bandwidth increases the settling time and results in unacceptable TX-RX turnaround time performance.

Chip Information

TRANSISTOR COUNT: 13,607

MAX2820/MAX2820A/MAX2821/MAX2821A

2.4GHz 802.11b Zero-IF Transceivers

Typical Application Circuit

MAX2820/MAX2820A/MAX2821/MAX2821A

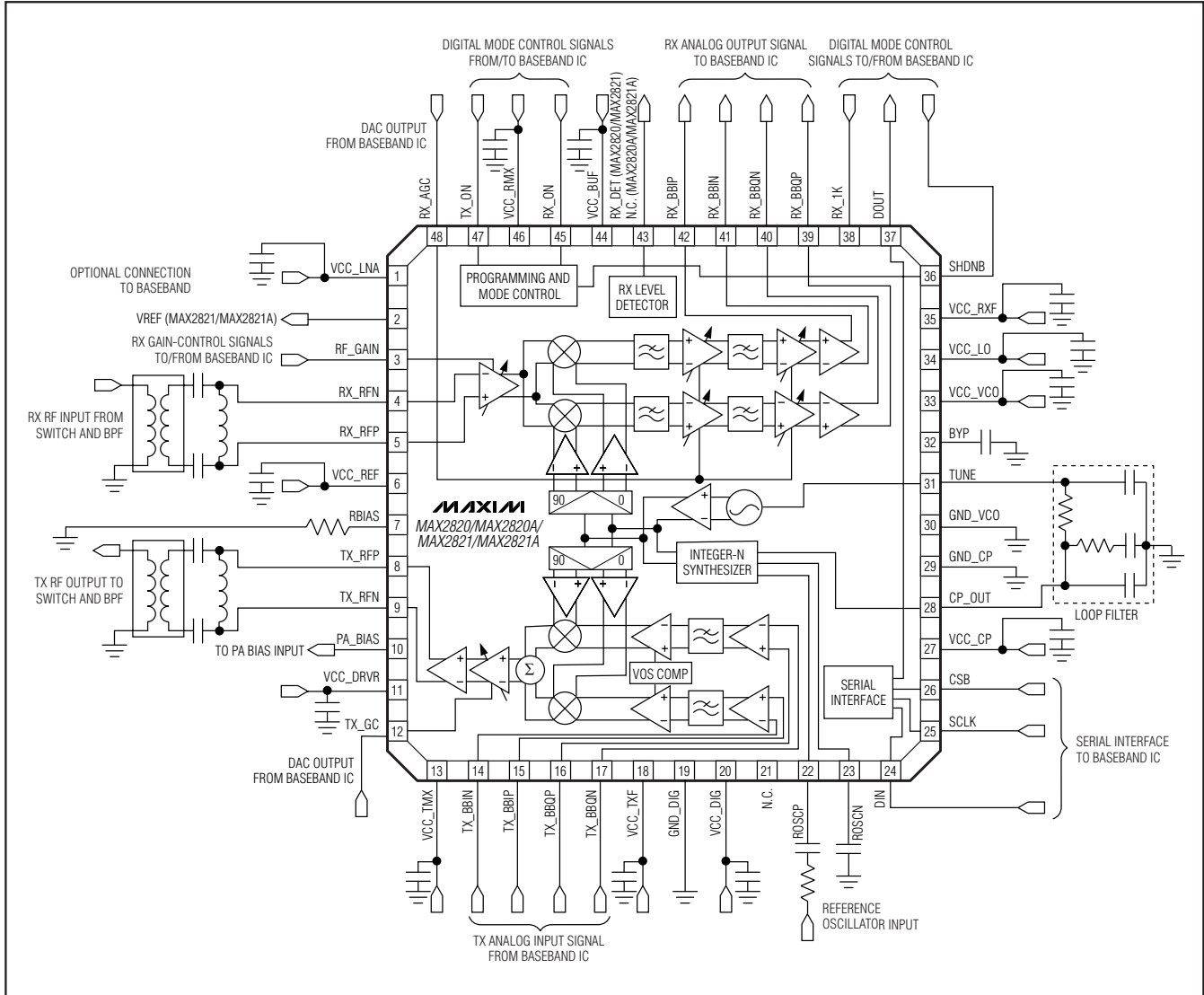

2.4GHz 802.11b Zero-IF Transceivers

Package Information

(The package drawing(s) in this data sheet may not reflect the most current specifications. For the latest package outline information, go to www.maxim-ic.com/packages.)

MAX2820/MAX2820A/MAX2821/MAX2821A

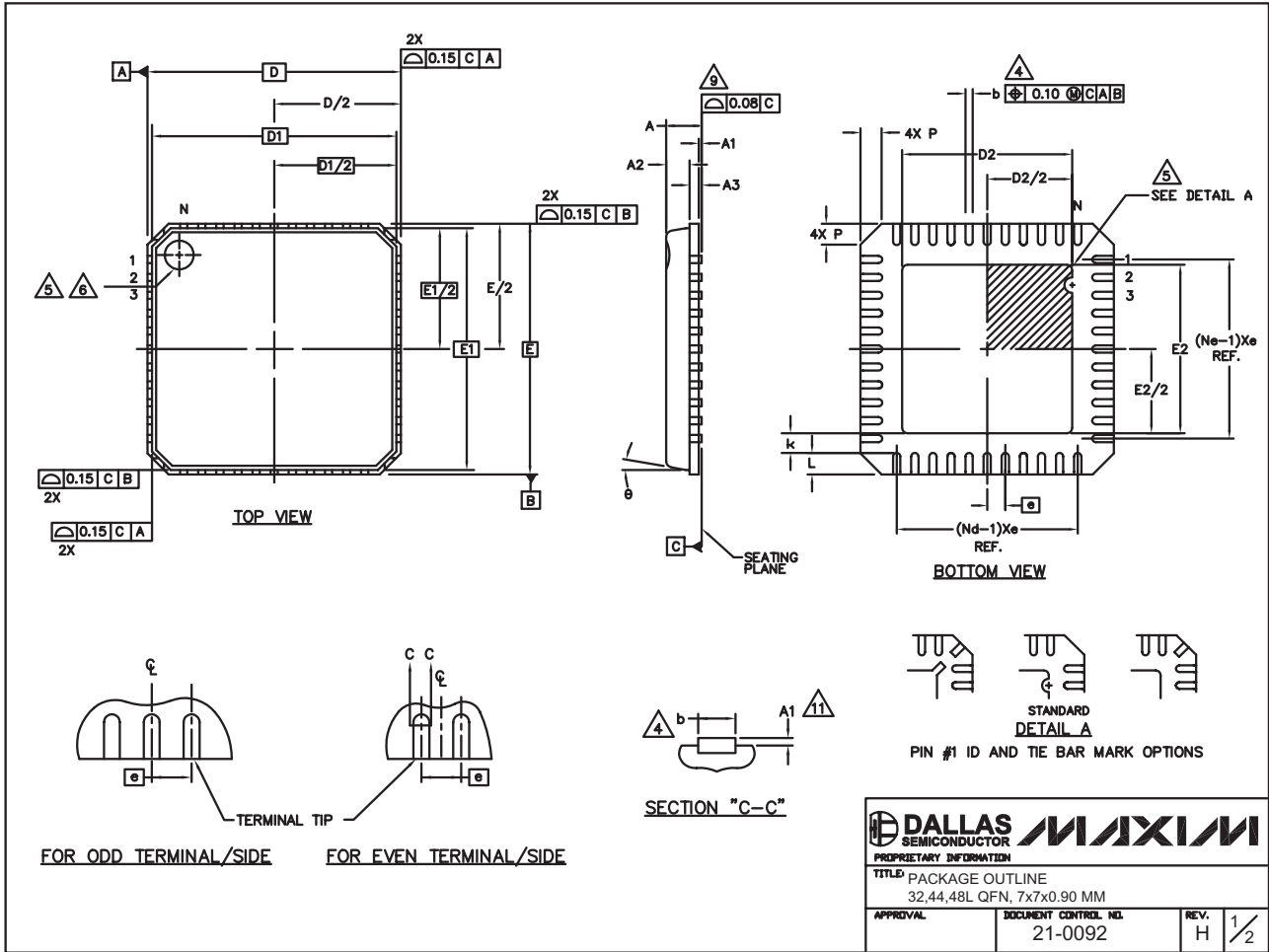

2.4GHz 802.11b Zero-IF Transceivers

Package Information (continued)

(The package drawing(s) in this data sheet may not reflect the most current specifications. For the latest package outline information, go to www.maxim-ic.com/packages.)

COMMON DIMENSIONS									
PKG	32L 7x7			44L 7x7			48L 7x7		
SYMBOL	MIN.	NOM.	MAX.	MIN.	NOM.	MAX.	MIN.	NOM.	MAX.
A	0.80	0.90	1.00	0.80	0.90	1.00	0.80	0.90	1.00
A1	0.00	0.01	0.05	0.00	0.01	0.05	0.00	0.01	0.05
A2	0.00	0.65	1.00	0.00	0.65	1.00	0.00	0.65	1.00
A3	0.20 REF			0.20 REF			0.20 REF		
b	0.23	0.28	0.35	0.18	0.23	0.30	0.18	0.23	0.30
D	6.90	7.00	7.10	6.90	7.00	7.10	6.90	7.00	7.10
D1	6.75 BSC			6.75 BSC			6.75 BSC		
E	6.90	7.00	7.10	6.90	7.00	7.10	6.90	7.00	7.10
E1	6.75 BSC			6.75 BSC			6.75 BSC		
e	0.65 BSC			0.50 BSC			0.50 BSC		
k	0.25	-	-	0.25	-	-	0.25	-	-
L	0.35	0.55	0.75	0.35	0.55	0.75	0.30	0.40	0.50
N	32			44			48		
Nd	8			11			12		
Ne	8			11			12		
P	0.00	0.42	0.60	0.00	0.42	0.60	0.00	0.42	0.60
U	0"		12"	0"		12"	0"		12"

EXPOSED PAD VARIATIONS						
PKG. CODES	D2			E2		
	MIN.	NOM.	MAX.	MIN.	NOM.	MAX.
G3277-2	4.55	4.70	4.85	4.55	4.70	4.85
G4477-1	3.65	3.80	3.95	3.65	3.80	3.95
G4477-2	4.55	4.70	4.85	4.55	4.70	4.85
G4477-3	3.15	3.30	3.45	3.15	3.30	3.45
G4877-1	4.95	5.10	5.25	4.95	5.10	5.25
G4877-2	5.45	5.60	5.75	5.45	5.60	5.75

NOTES:

1. DIE THICKNESS ALLOWABLE IS 0.305mm MAXIMUM (.012 INCHES MAXIMUM).
2. DIMENSIONING & TOLERANCES CONFORM TO ASME Y14.5M. - 1994.
3. N IS THE NUMBER OF TERMINALS.
Nd IS THE NUMBER OF TERMINALS IN X-DIRECTION & Ne IS THE NUMBER OF TERMINALS IN Y-DIRECTION.
4. DIMENSION b APPLIES TO PLATED TERMINAL AND IS MEASURED BETWEEN 0.20 AND 0.25mm FROM TERMINAL TIP.
5. THE PIN #1 IDENTIFIER MUST EXIST ON THE TOP SURFACE OF THE PACKAGE BY USING INDENTATION MARK OR INK/LASER MARKED. DETAILS OF PIN #1 IDENTIFIER IS OPTIONAL, BUT MUST BE LOCATED WITHIN ZONE INDICATED.
6. EXACT SHAPE AND SIZE OF THIS FEATURE IS OPTIONAL.
7. ALL DIMENSIONS ARE IN MILLIMETERS.
8. PACKAGE WARPAGE MAX 0.08mm.
9. APPLIED FOR EXPOSED PAD AND TERMINALS. EXCLUDE EMBEDDED PART OF EXPOSED PAD FROM MEASURING.
10. MEETS JEDEC MO220 EXCEPT DIMENSION "b" MINIMUM.
11. APPLY ONLY FOR TERMINAL.
12. THIS PACKAGE OUTLINE APPLIES TO ANVIL SINGULATION(STEPED SIDES).

<small>PROPRIETARY INFORMATION</small>		
<small>TITLE PACKAGE OUTLINE, 32,44,48L QFN, 7x7x0.90 MM</small>		
<small>APPROVAL</small>	<small>DOCUMENT CONTROL NO.</small> 21-0092	<small>REV.</small> H 2/2

2.4GHz 802.11b Zero-IF Transceivers

Package Information (continued)

(The package drawing(s) in this data sheet may not reflect the most current specifications. For the latest package outline information, go to www.maxim-ic.com/packages.)



COMMON DIMENSIONS															
PKG	32L 7x7			44L 7x7			48L 7x7			CUSTOM PKG. (T4877-1) 48L 7x7			56L 7x7		
SYMBOL	MIN.	NOM.	MAX.	MIN.	NOM.	MAX.	MIN.	NOM.	MAX.	MIN.	NOM.	MAX.	MIN.	NOM.	MAX.
A	0.70	0.75	0.80	0.70	0.75	0.80	0.70	0.75	0.80	0.70	0.75	0.80	0.70	0.75	0.80
A1	0	0.02	0.05	0	0.02	0.05	0	0.02	0.05	0	0.02	0.05	0	-	0.05
A2	0.20 REF.			0.20 REF.			0.20 REF.			0.20 REF.			0.20 REF.		
b	0.25	0.30	0.35	0.20	0.25	0.30	0.20	0.25	0.30	0.20	0.25	0.30	0.15	0.20	0.25
D	6.90	7.00	7.10	6.90	7.00	7.10	6.90	7.00	7.10	6.90	7.00	7.10	6.90	7.00	7.10
E	6.90	7.00	7.10	6.90	7.00	7.10	6.90	7.00	7.10	6.90	7.00	7.10	6.90	7.00	7.10
e	0.65 BSC.			0.50 BSC.			0.50 BSC.			0.50 BSC.			0.40 BSC.		
k	0.25	-	-	0.25	-	-	0.25	-	-	0.25	-	-	0.25	0.35	0.45
L	0.45	0.55	0.65	0.45	0.55	0.65	0.30	0.40	0.50	0.45	0.55	0.65	0.40	0.50	0.60
L1	-	-	-	-	-	-	-	-	-	-	-	-	0.30	0.40	0.50
N	32			44			48			44			56		
ND	8			11			12			10			14		
NE	8			11			12			12			14		

EXPOSED PAD VARIATIONS									
PKG. CODES	DEPOPULATED LEADS	D2			E2			JEDEC M0220 REV. C	DOWN BONDS ALLOWED
		MIN.	NOM.	MAX.	MIN.	NOM.	MAX.		
T3277-1	-	4.55	4.70	4.85	4.55	4.70	4.85	-	NO
T3277-2	-	4.55	4.70	4.85	4.55	4.70	4.85	-	YES
T4477-1	-	4.55	4.70	4.85	4.55	4.70	4.85	WKD-1	NO
T4477-2	-	4.55	4.70	4.85	4.55	4.70	4.85	WKD-1	YES
T4477-3	-	4.55	4.70	4.85	4.55	4.70	4.85	WKD-1	YES
T4877-1**	13,24,37,48	4.20	4.30	4.40	4.20	4.30	4.40	-	NO
T4877-2	-	5.45	5.60	5.63	5.45	5.60	5.63	-	NO
T4877-3	-	4.95	5.10	5.25	4.95	5.10	5.25	-	YES
T4877-4	-	5.45	5.60	5.63	5.45	5.60	5.63	-	YES
T4877-5	-	2.40	2.60	2.40	2.50	2.60	2.40	-	NO
T4877-6	-	5.45	5.60	5.63	5.45	5.60	5.63	-	NO
T5677-1	-	5.20	5.30	5.40	5.20	5.30	5.40	-	YES

** NOTE: T4877-1 IS A CUSTOM 48L PKG. WITH 4 LEADS DEPOPULATED. TOTAL NUMBER OF LEADS ARE 44.

NOTES:

1. DIMENSIONING & TOLERANCING CONFORM TO ASME Y14.5M-1994.
2. ALL DIMENSIONS ARE IN MILLIMETERS. ANGLES ARE IN DEGREES.
3. N IS THE TOTAL NUMBER OF TERMINALS.
4. THE TERMINAL #1 IDENTIFIER AND TERMINAL NUMBERING CONVENTION SHALL CONFORM TO JESD 95-1 SPP-012. DETAILS OF TERMINAL #1 IDENTIFIER ARE OPTIONAL, BUT MUST BE LOCATED WITHIN THE ZONE INDICATED. THE TERMINAL #1 IDENTIFIER MAY BE EITHER A MOLD OR MARKED FEATURE.
5. DIMENSION b APPLIES TO METALLIZED TERMINAL AND IS MEASURED BETWEEN 0.25 mm AND 0.30 mm FROM TERMINAL TIP.
6. ND AND NE REFER TO THE NUMBER OF TERMINALS ON EACH D AND E SIDE RESPECTIVELY.
7. DEPOPULATION IS POSSIBLE IN A SYMMETRICAL FASHION.
8. COPLANARITY APPLIES TO THE EXPOSED HEAT SINK SLUG AS WELL AS THE TERMINALS.
9. DRAWING CONFORMS TO JEDEC M0220 EXCEPT THE EXPOSED PAD DIMENSIONS OF T3277-1; T4877-1/-2/-3/-4/-5/-6 & T5677-1.
10. WARPAGE SHALL NOT EXCEED 0.10 mm.

 	
<small>PROPRIETARY INFORMATION</small>	
TITLE: PACKAGE OUTLINE 32, 44, 48, 56L THIN QFN, 7x7x0.8mm	
APPROVAL	DOCUMENT CONTROL NO. 21-0144
REV. D	2/2

Maxim cannot assume responsibility for use of any circuitry other than circuitry entirely embodied in a Maxim product. No circuit patent licenses are implied. Maxim reserves the right to change the circuitry and specifications without notice at any time.

26 **Maxim Integrated Products, 120 San Gabriel Drive, Sunnyvale, CA 94086 408-737-7600**