

HiPerFRED²

High Performance Fast Recovery Diode
Low Loss and Soft Recovery
Common Cathode

$V_{RRM} = 300\text{ V}$
 $I_{FAV} = 2 \times 30\text{ A}$
 $t_{rr} = 35\text{ ns}$

Part number

DPG 60 C 300 QB

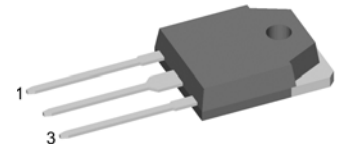
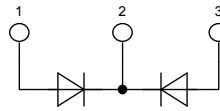

Backside: cathode

Features / Advantages:

- Planar passivated chips
- Very low leakage current
- Very short recovery time
- Improved thermal behaviour
- Very low I_{rm} -values
- Very soft recovery behaviour
- Avalanche voltage rated for reliable operation
- Soft reverse recovery for low EMI/RFI
- Low I_{rm} reduces:
 - Power dissipation within the diode
 - Turn-on loss in the commutating switch

Applications:

- Antiparallel diode for high frequency switching devices
- Antisaturation diode
- Snubber diode
- Free wheeling diode
- Rectifiers in switch mode power supplies (SMPS)
- Uninterruptible power supplies (UPS)

Package:

- Housing: TO-3P
- Industry standard outline compatible with TO-247
- Epoxy meets UL 94V-0
- RoHS compliant

Ratings

Symbol	Definition	Conditions	Ratings			Unit	
			min.	typ.	max.		
V_{RRM}	max. repetitive reverse voltage	$T_{VJ} = 25^\circ\text{C}$			300	V	
I_R	reverse current	$V_R = 300\text{V}$			1	μA	
		$V_R = 300\text{V}$			0.1	mA	
V_F	forward voltage	$I_F = 30\text{A}$			1.34	V	
		$I_F = 60\text{A}$			1.63	V	
		$I_F = 30\text{A}$	$T_{VJ} = 150^\circ\text{C}$			1.06	V
		$I_F = 60\text{A}$	$T_{VJ} = 150^\circ\text{C}$			1.39	V
I_{FAV}	average forward current	rectangular $d = 0.5$	$T_C = 135^\circ\text{C}$		30	A	
V_{F0}	threshold voltage	} for power loss calculation only	$T_{VJ} = 175^\circ\text{C}$		0.70	V	
r_F	slope resistance				10.5	m Ω	
R_{thJC}	thermal resistance junction to case				0.95	K/W	
T_{VJ}	virtual junction temperature		-55		175	$^\circ\text{C}$	
P_{tot}	total power dissipation		$T_C = 25^\circ\text{C}$		160	W	
I_{FSM}	max. forward surge current	$t = 10\text{ ms}$ (50 Hz), sine	$T_{VJ} = 45^\circ\text{C}$		360	A	
I_{RM}	max. reverse recovery current		$T_{VJ} = 25^\circ\text{C}$		3	A	
		$I_F = 30\text{ A}; V_R = 200\text{ V}$	$T_{VJ} = 125^\circ\text{C}$		7	A	
t_{rr}	reverse recovery time	$-di_F/dt = 200\text{ A}/\mu\text{s}$	$T_{VJ} = 25^\circ\text{C}$		35	ns	
			$T_{VJ} = 125^\circ\text{C}$		55	ns	
C_J	junction capacitance	$V_R = 150\text{ V}; f = 1\text{ MHz}$	$T_{VJ} = 25^\circ\text{C}$		50	pF	

Symbol	Definition	Conditions	Ratings			Unit
			min.	typ.	max.	
I_{RMS}	RMS current	per pin ¹⁾			50	A
R_{thCH}	thermal resistance case to heatsink			0.25		K/W
T_{stg}	storage temperature		-55		150	°C
Weight				5		g
M_D	mounting torque		0.8		1.2	Nm
F_C	mounting force with clip		20		120	N

¹⁾ I_{RMS} is typically limited by: 1. pin-to-chip resistance; or by 2. current capability of the chip.
 In case of 1, a common cathode/anode configuration and a non-isolated backside, the whole current capability can be used by connecting the backside.

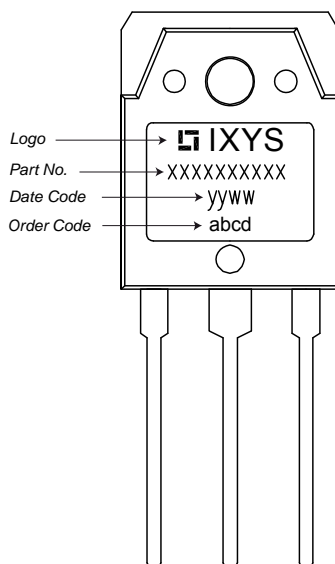
Product Marking

Part number

- D = Diode
- P = HiPerFRED
- G = extreme fast
- 60 = Current Rating [A]
- C = Common Cathode
- 300 = Reverse Voltage [V]
- QB = TO-3P (3)

Ordering	Part Name	Marking on Product	Delivering Mode	Base Qty	Code Key
Standard	DPG 60 C 300 QB	DPG60C300QB	Tube	30	501894

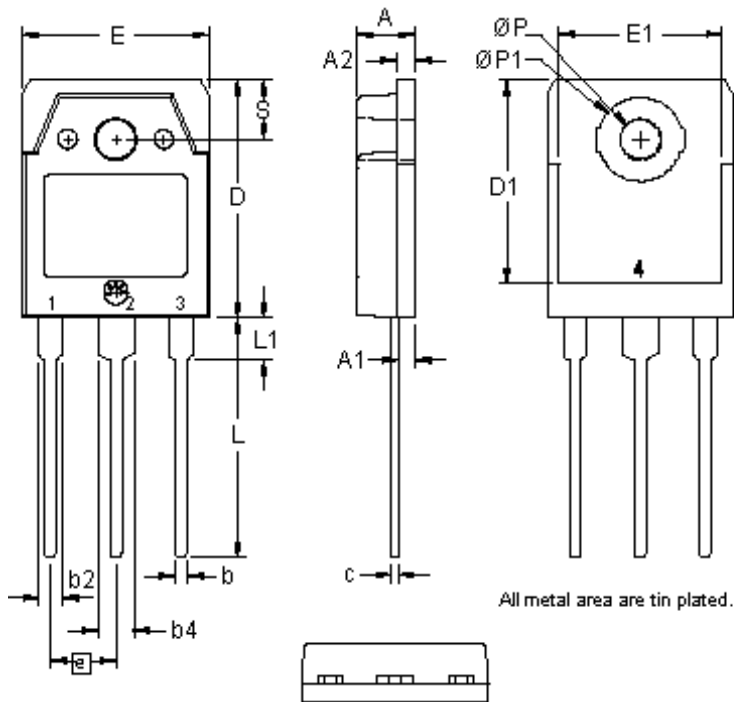
Similar Part	Package	Voltage Class
DPG60C300HB	TO-247AD (3)	300
DPG60C300HJ	ISOPLUS247 (3)	300
DPG60C300PC	TO-263AB (D2Pak)	300
DPF60C300HB	TO-247AD (3)	300
DPG80C300HB	TO-247AD (3)	300

Outlines TO-3P

SYM	INCHES		MILLIMETERS	
	MIN	MAX	MIN	MAX
A	.185	.193	4.70	4.90
A1	.051	.059	1.30	1.50
A2	.057	.065	1.45	1.65
b	.035	.045	.090	1.15
b2	.075	.087	1.90	2.20
b4	.114	.126	2.90	3.20
c	.022	.031	.055	.080
D	.780	.791	19.80	20.10
D1	.665	.677	16.90	17.20
E	.610	.622	15.50	15.80
E1	.531	.539	13.50	13.70
e	.215 BSC		.545 BSC	
L	.779	.795	19.80	20.20
L1	.134	.142	3.40	3.60
ØP	.126	.134	3.20	3.40
ØP1	.272	.280	6.90	7.10
S	.193	.201	4.90	5.10

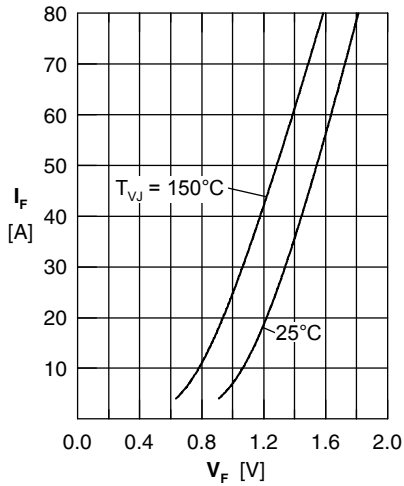

Fig. 1 Forward current I_F versus forward voltage V_F

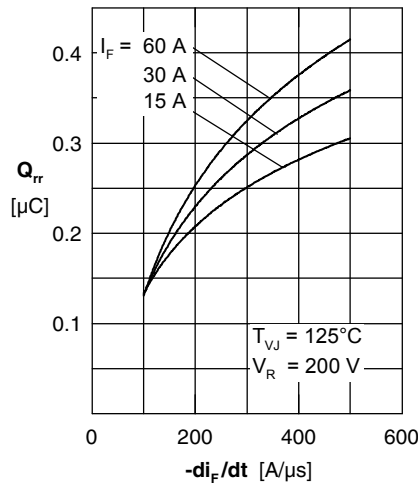

Fig. 2 Typ. reverse recovery charge Q_{rr} versus $-di_F/dt$

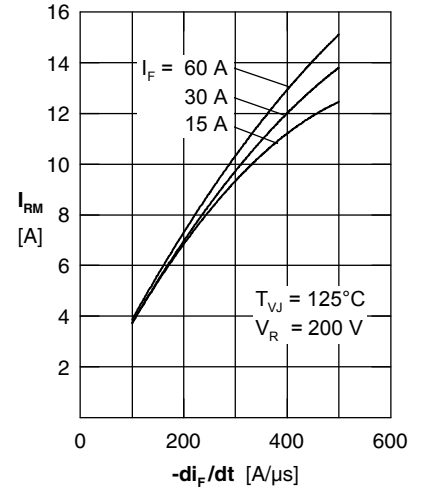

Fig. 3 Typ. reverse recovery current I_{RM} versus $-di_F/dt$

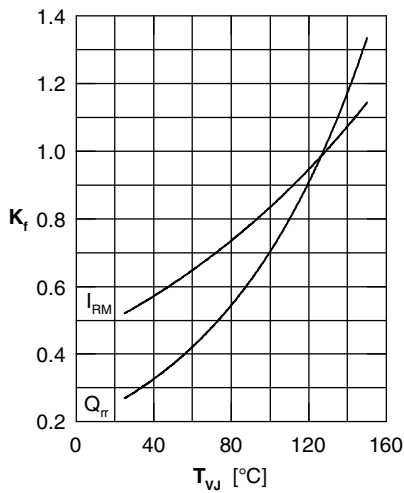

Fig. 4 Dynamic parameters Q_{rr} , I_{RM} versus T_{VJ}

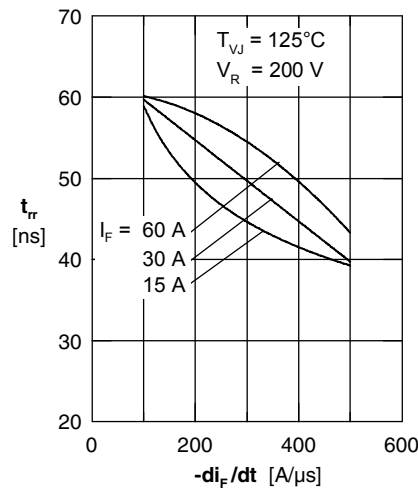

Fig. 5 Typ. reverse recovery time t_{rr} versus $-di_F/dt$

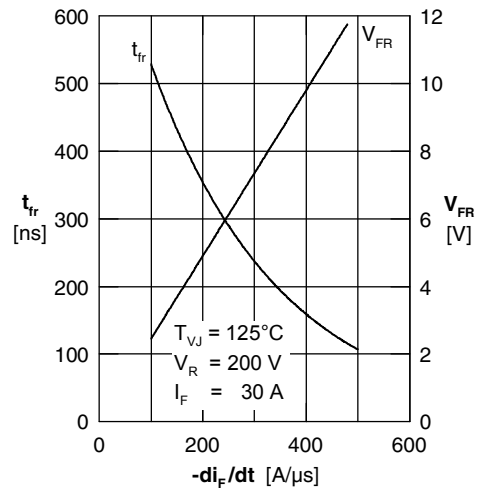

Fig. 6 Typ. forward recovery voltage V_{FR} & forward recovery time t_{fr} vs. di_F/dt

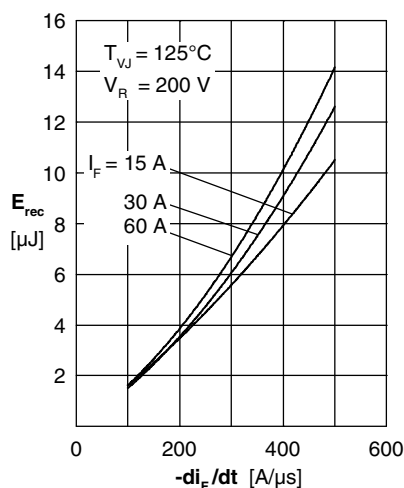

Fig. 7 Typ. recovery energy E_{rec} versus $-di_F/dt$

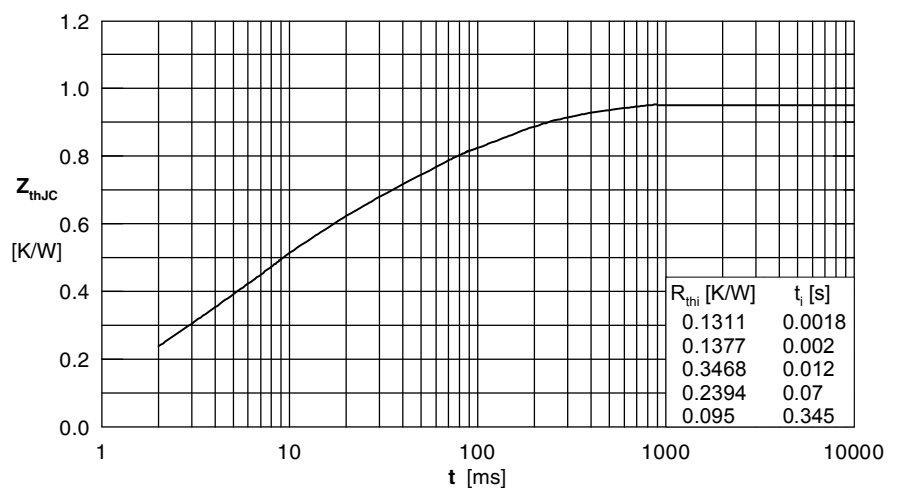

Fig. 8 Transient thermal impedance junction to case