

Cooper Hand Tools



Electronics Pliers, Cutters and Tweezers

COOPER Hand Tools

	Page
Tweezers	4-16
Pointed Tips	5-10
Flat Round Tips	10-11
Tweezers with Ergonomic Handles	11
SMD Tweezers	12-13
Special Gripping Tweezer	13
Wafer Tweezers	14
Cutting Tweezers	15
Stripping Tweezers	15
Extraction Tweezers/Connector Tools	16
Cutters	17-36
Side Cutters	21-27
Side Cutters with Ergonomic Handles	27-28
Tip Cutters	29-33
Tip Cutters with Ergonomic Handles	33
Pneumatic Side Cutters and Tip Cutters	34-35
Distance Cutters	36
Pliers	37-39
EROP Cutters and Pliers	40-42
Stripping Tools	42-43
Pre-Forming Tools	44-48
For Passive Components	44-45
For Active Components	46-48
IC and SMD Tools	48-49
Inserting and Extracting	48
Straightening	48
Cutting + Trimming	49
Fibre Optic Tools	50
Kits	51
Vacuum Manipulator	52-55
Index	58-59



Swiss Made

Erem Tools - Precision Made in Switzerland

Precision is sought by many but achieved by few. The quality and performance of Erem hand tools is the result of more than 25 years of research and manufacturing expertise. Erem is constantly innovating and developing new tools for use in areas as diverse as electronics, aviation, biology, medical (cardio-vascular, cannulae applications), watch and clock industry, telecoms.

Although your initial investment in Erem tools may be higher than some other tools, the final cost based on medium to long term use will be lower due to the economy resulting from the quality of the tools and in the case of the cutters, the free of charge resharpener. The inherent precision of the tools will be reflected in the quality of your products.



Erem Tweezers

Erem tweezers are high precision tools of constant high quality. Precise finished and symmetrical tips together with easy handling and perfect balance makes them outstanding tools. The range of Erem tweezers covers a wide diversity of applications. It is produced in many shapes and can be manufactured from different materials. The most popular models are available in a lower cost economy (SL) range. In all models, the type number of the tweezers is stamped, not printed.

The Material

Erem offers a wide variety of materials, carbon steel, stainless steel, Erem special stainless steel, Nickel plated, Brass or Titanium. The most common ones are explained below:

Carbon Steel

Carbon steel tweezers have hard tips but the rust resistance is low and they are magnetic. Carbon steel tweezers have no suffix.

Stainless Steel

Tweezers from stainless steel have strong tips and are rust resistant but are not as hard and longlasting as carbon steel tweezers. Stainless steel tweezers have the suffix „S“.

Erem Special Stainless Steel

This grade of steel is a non magnetic, rust resistant, anti acid alloy.

It is temperature resistant up to 300°C.

Tweezers from special stainless steel have the suffix „SA“



Coating

The Pyroplast coating is an exclusive by Erem. The advantages are:

- heat resistance up to 500°C (932°F), almost twice as much as PTFE, Cralon, etc.
 - no capillary effect on tips while soldering (non-stick property)
 - no contamination caused by positive or negative charge
 - hydrophobic
 - radiation resistant
 - thickness 60-80 µ
- the suffix is „PYR“.

Note: The Pyroplast coating is not available for all Erem tweezers. It is made to order and needs a minimum order quantity. Please ask for further information.



Ergonomic

Developed by Erem, tweezers with ergonomically shaped handles to alleviate the problem of **Repetitive Strain Injuries (RSI)** and reduce operator fatigue. The range has been selected to include the most popular tip shapes (see page 11). The main features are:

- ergonomic design for operator comfort and ease of control
- two colour, thermally insulated soft grip handles moulded from a synthetic material
- ESD safe
- the grips absorb heat for additional user protection
- manufactured from non magnetic, acid resistant, stainless steel alloy
- supplied in a rigid, transparent plastic box for protection and storage

The prefix for ergonomic tweezers is “E”.

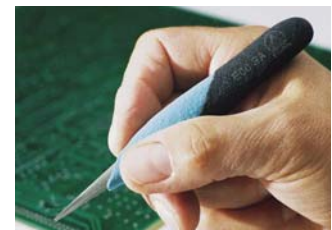

Suffix

None	carbon steel
E (Prefix)	ergonomic handles
M	Brass, soft material to avoid damage, no sparks
N	Nickel-Silver alloy
PYR	Pyroplast coating
RU	anti adhesive coating
S	stainless steel
SA, CA	special stainless steel, non-magnetic, acid resistant
SL	economy version
TA	Titanium, non-magnetic, lightweight, high temperature resistant
Z	Nickel plated

Pointed Tips Straight



Pointed Tips Straight
 Main applications:
 for conventional and precision handling of small parts like tissue, components, wires. For tasks in micro electronics industry, medicine, laboratories and other applications where high precision is required.

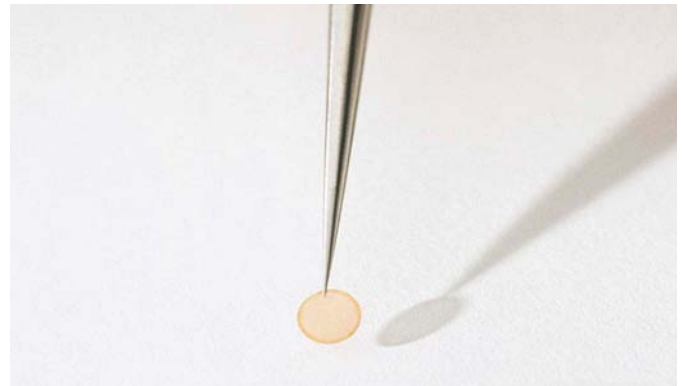

Length 80 mm



Model	Length	Weight	Description
M55	80 mm	6 g	Stainless steel, anti-glare finish Micro tweezers, very small, very fine tips, e.g. for work under microscope

Length 108 mm



Model	Length	Weight	Description
ACSA	108 mm	16 g	Special stainless steel, anti-glare finish, non-magnetic Precision tweezers with serrated grips for anti-slip handling. For bending and handling.
20AS	108 mm	12 g	Stainless steel, anti-glare finish Precision tweezers with serrated grips and inside serrated tips for anti-slip handling. Guide pin to avoid tip overlapping. For bending and handling.

Length 110 mm



Model	Length	Weight	Description
3CS	110 mm	11 g	Stainless steel, anti-glare finish Precision tweezers with long tips for delicate circuit board assembly.
3CSA	110 mm	11 g	Special stainless steel, anti-glare finish, non-magnetic Precision tweezers for delicate circuit board assembly.
3CSASL	110 mm	11 g	Special stainless steel, anti-glare finish, non-magnetic Same as 3CSA but economy model.
3CTA	110 mm	8 g	Titanium, non-magnetic Same as 3CSA but Titanium for heat resistance and light weight.
53CSA	110 mm	11 g	Special stainless steel, anti-glare finish, non-magnetic Precision tweezers with crush-proof design for handling of delicate parts.

Pointed Tips Straight

Length 120 mm



Model	Length	Weight	Description
3SA	120 mm	14 g	Special stainless steel, anti-glare finish, non-magnetic Precision tweezers for micro electronics. Precision work.
3SASL	120 mm	14 g	Special stainless steel, anti-glare finish, non-magnetic Same as 3SA but economy model.
1SA	120 mm	14 g	Special stainless steel, anti-glare finish, non-magnetic Precision tweezers for general use.
1SASL	120 mm	14 g	Special stainless steel, anti-glare finish, non-magnetic Same as 1SA but economy model.
00SA	120 mm	20 g	Special stainless steel, anti-glare finish, non-magnetic Precision tweezers for general purpose e.g. electronic assembly, very sturdy.
00SASL	120 mm	20 g	Special stainless steel, anti-glare finish, non-magnetic Same as 00SA but economy model.
00CSA	120 mm	18 g	Special stainless steel, anti-glare finish, non-magnetic Same as 00SA but smaller version.
00BSA	120 mm	20 g	Special stainless steel, anti-glare finish, non-magnetic Same as 00SA but with serrated grips.
00DSA	120 mm	20 g	Special stainless steel, anti-glare finish, non-magnetic Same as 00SA but with serrated grips and inside serrated tips.
64SA	120 mm	17 g	Special stainless steel, anti-glare finish, non-magnetic Precision tweezers with serrated grips.
11N	120 mm	17 g	Nickel-Silver alloy, anti-glare finish, non-magnetic Precision tweezers Nickel-Silver alloy, perfect non-magnetic.
AAZ	120 mm	16 g	Nickel plated Precision tweezers Nickel plated, for electronics assembly.

Length 125 mm



Model	Length	Weight	Description
AAS	125 mm	16 g	Stainless steel, anti-glare finish Precision tweezers with strong but fine tips. For universal use.
AASSL	125 mm	16 g	Stainless steel, anti-glare finish Same as AAS but economy model.

Pointed Tips Straight



Model	Length	Weight	Description
AASA	125 mm	16 g	Special stainless steel, anti-glare finish, non-magnetic Precision tweezers with strong but fine tips. For universal use.
AASASL	125 mm	16 g	Special stainless steel, anti-glare finish, non-magnetic Same as AASA but economy model.
AM	125 mm	17 g	Brass, polished Precision tweezers brass. Soft metal protects sensitive parts against damage. No sparks.

Length 130 mm



Model	Length	Weight	Description
249SA	130 mm	20 g	Special stainless steel / PPS, anti-glare finish, non-magnetic ESD safe, suitable for fibre optics Precision tweezers with serrated grips and synthetic tips (PPS). Heat resistant up to 250°C (480°F). Resistant to acids and solder. Waterproof, ESD safe. Does not damage fibre optic cores.
249CER	130 mm	24 g	Special stainless steel / Ceramic anti-glare finish, non-magnetic Same as 249SA but with Ceramic tips for heat resistance up to 900°C (1500°F).

Length 140 mm



Model	Length	Weight	Description
RRS	140 mm	30 g	Stainless steel, anti-glare finish Precision tweezers, long version, very strong.
SSSA	140 mm	11 g	Special stainless steel, anti-glare finish, non-magnetic Precision tweezers with narrow grips and low tension. Extra long for use near heat, die attachment.
SSSASL	140 mm	11 g	Special stainless steel, anti-glare finish, non-magnetic Same as SSSA but economy model.

Length 150 mm



Model	Length	Weight	Description
29SA	150 mm	26 g	Special stainless steel, anti-glare finish, non-magnetic, reverse action Precision tweezers with fibre-grip handles for heat protection. Reverse action for permanent holding parts.

Length 160 mm



Model	Length	Weight	Description
21SA	160 mm	23 g	Special stainless steel, anti-glare finish, non-magnetic Precision tweezers, long version, with serrated grips and inside serrated tips, strong.

Pointed Tips Straight Relieved

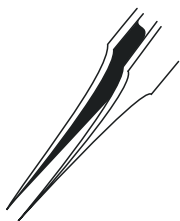

Pointed Tips Straight Relieved

Main application:
for better product visibility
e.g. under microscope or
working in confined areas,
for handling tiny components.

Length 90 mm



Model	Length	Weight	Description
M4AS	90 mm	9 g	Stainless steel, anti-glare finish Micro tweezers with very small, very fine tips, e.g. for working under microscope or handling tiny parts in HF assembly. Strong tips due to hardened stainless steel.

Length 110 mm



Model	Length	Weight	Description
4SA	110 mm	13 g	Special stainless steel, anti-glare finish, non-magnetic Precision tweezers with very fine points..
4SASL	110 mm	13 g	Special stainless steel, anti-glare finish, non-magnetic Same as 4SA but economy model.

Length 115 mm



Model	Length	Weight	Description
5MBS	115 mm	12 g	Stainless steel, anti-glare finish Precision tweezers with extremely fine tips (~ 0,03 x 0,07 mm) for use in dissection procedures and handling of very small samples e.g. under microscope. Only for use with soft materials.
5FSA	115 mm	12 g	Special stainless steel, anti-glare finish, non-magnetic Precision tweezers with extremely fine tips (~ 0,05 x 0,1 mm) for use in dissection procedures and handling of very small samples e.g. under microscope. Only for use with soft materials.
5SA	115 mm	12 g	Special stainless steel, anti-glare finish, non-magnetic Precision tweezers with very fine tips e.g. for handling fine wires.
5SASL	115 mm	12 g	Special stainless steel, anti-glare finish, non-magnetic Same as 5SA but economy model
2SA	115 mm	16 g	Special stainless steel, anti-glare finish, non-magnetic Precision tweezers with medium tips.
2SASL	115 mm	16 g	Special stainless steel, anti-glare finish, non-magnetic Same as 2SA but economy model.

Pointed Tips Straight Relieved

Length 120 mm



Model	Length	Weight	Description
258SA	120 mm	15 g	<p>Special stainless steel/PPS, anti-glare finish, non-magnetic, ESD safe</p> <p>Precision tweezers with serrated grips and synthetic tips (PPS). Heat resistant up to 250°C (480°F). Resistant to acids and solder. Waterproof, ESD safe.</p>

Pointed Tips Bent



Pointed Tips Bent

Main application:
for better product visibility
and handling e.g. working
in confined areas and under
microscope.

Length 110 mm



Model	Length	Weight	Description
3CBS	110 mm	11 g	<p>∠ 40°, stainless steel, anti-glare finish</p> <p>Precision tweezers bent for delicate circuit board assembly.</p>

Length 115 mm



Model	Length	Weight	Description
5CSA	115 mm	12 g	<p>∠ 30°, special stainless steel, anti-glare finish, non-magnetic</p> <p>Precision tweezers curved, relieved.</p>
5BSA	115 mm	12 g	<p>∠ 30°, special stainless steel, anti-glare finish, non-magnetic</p> <p>Precision tweezers curved, relieved.</p>
51SA	115 mm	12 g	<p>∠ 30°, special stainless steel, anti-glare finish, non-magnetic</p> <p>Precision tweezers curved, relieved. Very fine tips.</p>
51SASL	115 mm	12 g	<p>∠ 30°, special stainless steel, anti-glare finish, non-magnetic</p> <p>Same as 51SA but economy model.</p>
5ASA	115 mm	12 g	<p>∠ 15°, special stainless steel, anti-glare finish, non-magnetic</p> <p>Precision tweezers oblique, relieved. Fine tips.</p>
5ASASL	115 mm	12 g	<p>∠ 15°, special stainless steel, anti-glare finish, non-magnetic</p> <p>Same as 5 ASA but economy model.</p>

Pointed Tips Bent

Length 120 mm



Model	Length	Weight	Description
7SA	120 mm	15 g	Special stainless steel, anti-glare finish, non-magnetic Precision tweezers curved, relieved. For easy handling in confined areas.
7SASL	120 mm	15 g	Special stainless steel, anti-glare finish, non-magnetic Same as 7SA but economy model.

Length 140 mm



Model	Length	Weight	Description
65ASA	140 mm	11 g	± 50°, special stainless steel, anti-glare finish, non-magnetic Precision tweezers bent. Very fine points. For handling extra fine components.

Length 150 mm



Model	Length	Weight	Description
24SA	150 mm	22 g	± 40°, special stainless steel, anti-glare finish, non-magnetic Precision tweezers bent. Serrated grips and inside serrated tips. Alignment pin. Useful for all soldering jobs and assembly.
30SA	150 mm	26 g	± 50°, special stainless steel, anti-glare finish, non-magnetic, reverse action Precision tweezers bent. With fibre-grip handles for heat protection. Reverse action for permanent holding parts. Useful e.g. for soldering jobs.

Flat Round Tips Straight

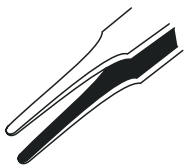

Flat Round Tips Straight

Main application:
for conventional holding
and gripping applications.

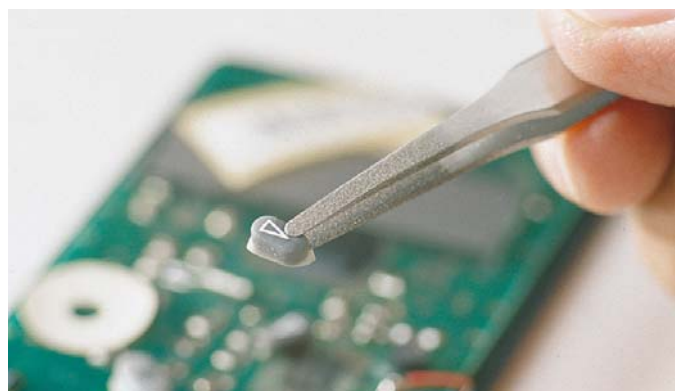

Length 120 mm



Model	Length	Weight	Description
2ASA	120 mm	15 g	Special stainless steel, anti-glare finish, non-magnetic Precision tweezers with medium tips for gripping.

Flat Round Tips Straight



Model	Length	Weight	Description
2ASASL	120 mm	15 g	Special stainless steel, anti-glare finish, non-magnetic Same as 2ASA but economy model.
2ASASLT	120 mm	16 g	Special stainless steel/PTFE, coated, anti-glare finish, non-magnetic Same as 2ASA but PTFE, coated tips for handling delicate parts.
2ASARU	120 mm	16 g	Special stainless steel/coated, anti-glare finish, non-magnetic Same as 2ASA but coated tips for handling adhesive parts, gaskets, Kapton ribbons, labels with negligible capillary effect.
25SA	120 mm	15 g	Special stainless steel, anti-glare finish, non-magnetic Precision tweezers with flat round tips. For gripping.
52ASA	120 mm	15 g	Special stainless steel, anti-glare finish, non-magnetic Precision tweezers with crush-proof design for handling of delicate parts.

Precision Tweezers with Ergonomic Handles*

Main applications:

Thermally insulated soft grips, ESD safe, ergonomically shaped to reduce operator's hand fatigue.

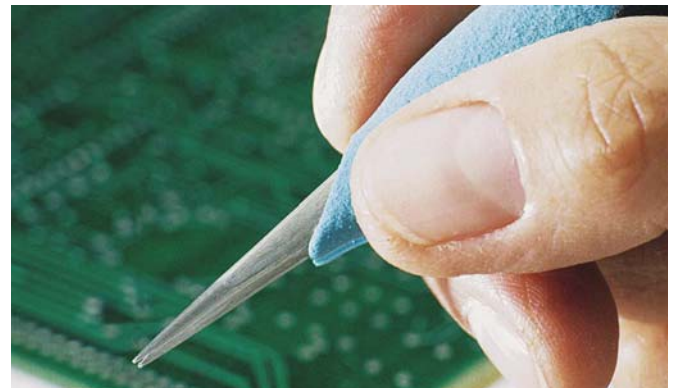

Model	Length	Weight	Description
E5SA	120 mm	25 g	Special stainless steel, ergonomic handles, non-magnetic, ESD-safe Ergonomic precision tweezers straight, very fine tips, e.g. for handling fine wires.
E3CSA	120 mm	25 g	Special stainless steel, ergonomic handles, non-magnetic, ESD-safe Ergonomic precision tweezers straight, long fine tips, for delicate circuit board assembly.
E00SA	120 mm	30 g	Special stainless steel, ergonomic handles, non-magnetic, ESD-safe Ergonomic precision tweezers straight, fine tips, for general use. Very sturdy.
E7SA	120 mm	28 g	Special stainless steel, ergonomic handles, non-magnetic, ESD-safe Ergonomic precision tweezers curved, fine tips, for easy manipulation in confined areas.
E2ASA	120 mm	28 g	Special stainless steel, ergonomic handles, non-magnetic, ESD-safe Ergonomic precision tweezers straight, flat round tips, for gripping.

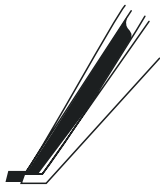

Note: colour coatings subject to variations without prior notice. * Ergonomic features see page 4.

SMD Tweezers



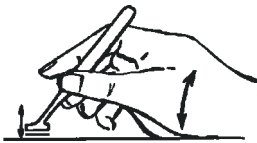
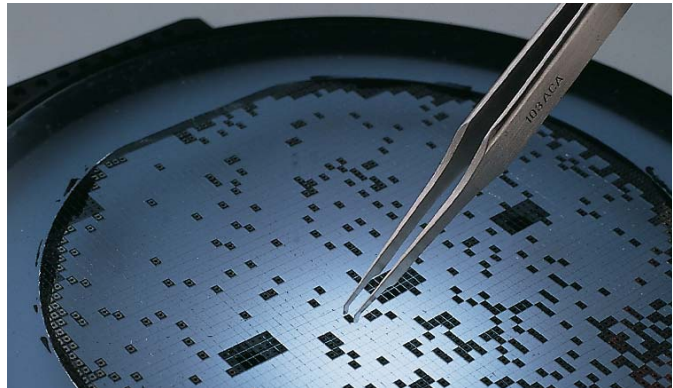

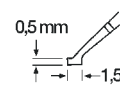

Angled Head
Main application:
for handling chips or minia-
ture SMD components.
For mounting on SMD
boards or Ceramic substra-
tes.

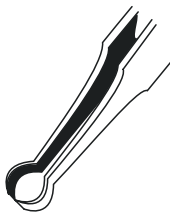

Model	Length	Weight	Description
102ACA 	115 mm	15 g	Special stainless steel, anti-glare finish, non-magnetic SMD tweezers with angled head and blunt edges to avoid board damage. For handling small components, mounting on SMD boards, hybrids ICs, watch hands, etc.
102ACAX 	115 mm	14 g	Special stainless steel, anti-glare finish, non-magnetic, reverse action Same as 102ACA but reverse action.
103ACA 	115 mm	15 g	45°, special stainless steel, anti-glare finish, non-magnetic SMD tweezers with angled head and blunt edges to avoid board damage. For handling of small components.



Rounded Head

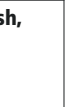

Model	Length	Weight	Description
39SA 	110 mm	15 g	Ø 0,3 mm, special stainless steel, anti-glare finish, non-magnetic Straight, serrated grips. For gripping wires and small cylindrical parts.
40 SA 	110 mm	15 g	Ø 0,4 mm, special stainless steel, anti-glare finish, non-magnetic Straight, serrated grips. For gripping wires and small cylindrical parts.
150SAMF 	120 mm	13 g	Ø 1,2 – 2,5 mm, special stainless steel, anti-glare finish, non-magnetic SMD tweezers straight, serrated grips. For gripping small cylindrical parts, mini MELFs. Very narrow tips.
150SAD 	120 mm	13 g	Ø 1,5 – 3 mm, special stainless steel, anti-glare finish, non-magnetic SMD tweezers straight, serrated grips. For gripping small cylindrical parts.

Rounded Head



Model	Length	Weight	Description
150SA 	120 mm	13 g	Ø 1,5 – 3 mm, special stainless steel, anti-glare finish, non-magnetic SMD tweezers straight, serrated grips. For gripping small cylindrical parts.
151SA 	120 mm	13 g	Ø 3 – 6 mm, special stainless steel, anti-glare finish, non-magnetic SMD tweezers straight, serrated grips. For gripping small cylindrical parts.

Rounded Head Bent



Model	Length	Weight	Description
32BSA	115 mm	17 g	45°, Ø 5 mm, special stainless steel, anti-glare finish, non-magnetic SMD tweezers bent. For small cylindrical components or insulated fibres.
32BSA20	115 mm	17 g	45°, Ø 2 mm, special stainless steel, anti-glare finish, non-magnetic Same as 32BSA but Ø 2 mm.
32BSA25	115 mm	17 g	45°, Ø 2,5 mm, special stainless steel, anti-glare finish, non-magnetic Same as 32BSA but Ø 2,5 mm.
150SAMB	115 mm	13 g	40°, Ø 1,2 - 2,5 mm, special stainless steel, anti-glare finish, non-magnetic SMD tweezers bent, serrated grips. For gripping small cylindrical parts.

Special Gripping Tweezers



Model	Length	Weight	Description
940AS	120 mm	17 g	Stainless steel, anti-glare finish Gripping tweezers with locking clip. For various applications. Resists a tensile force of ~ 5 kg.

Wafer Tweezers

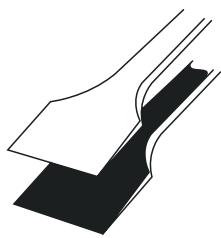

Wafer Tweezers
Main application:
for handling wafers from
3" to 6". Different coatings
or sizes on request.

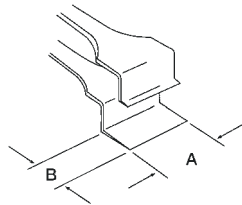

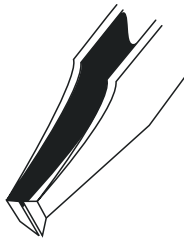

Model	Length	A	B	Weight	Description
91SA	125 mm	12 mm	7 mm	15 g	3" - 4", special stainless steel, anti-glare finish, non-magnetic Standard wafer tweezers to pick up 3" or 4" Silicon wafers. Serrated grips.
500ASA	130 mm	16 mm	8 mm	22 g	4" - 5", special stainless steel, anti-glare finish, non-magnetic Wafer tweezers with fingers to reduce the risk of damage. For 4" and 5" wafers. Serrated grips.
600ASA	130 mm	19,5 mm	8 mm	23 g	6", special stainless steel, anti-glare finish, non-magnetic Wafer tweezers with fingers to reduce the risk of damage. For 6" wafers. Serrated grips.
608ASA	130 mm	30 mm	8,5 mm	23 g	6", special stainless steel, anti-glare finish, non-magnetic Same as 600ASA but with 30 mm width.
600JSA	130 mm	20 mm	8 mm	24 g	4" - 6", special stainless steel, anti-glare finish, non-magnetic Wafer tweezers with free-floating PTFE, paddle for self adjustment on 4" - 6" wafers. Serrated grips.
140SA	120 mm	30 mm	5 mm	20 g	4" - 5", special stainless steel/Polyester, anti-glare finish, non-magnetic Wafer tweezers with Delrin tips. Available with adjustable opening screw. For 4" to 5" wafers. Serrated grips. Temperature resistance 170°C.
141SAP	150 mm	30 mm	8 mm	30 g	5" - 6", special stainless steel/PTFE., anti-glare finish, non-magnetic Wafer tweezers with Polyester tips. The perfect wafer tweezers. Will not damage Si, GaAs or Ti wafers. Serrated grips.
141SAPH	150 mm	30 mm	8 mm	30 g	5" - 6", special stainless steel/Halar, anti-glare finish, non-magnetic Same as 141SAP but with Halar coating and plastic tips without pigmentation. Halar is acids resistant.

Cutting Tweezers

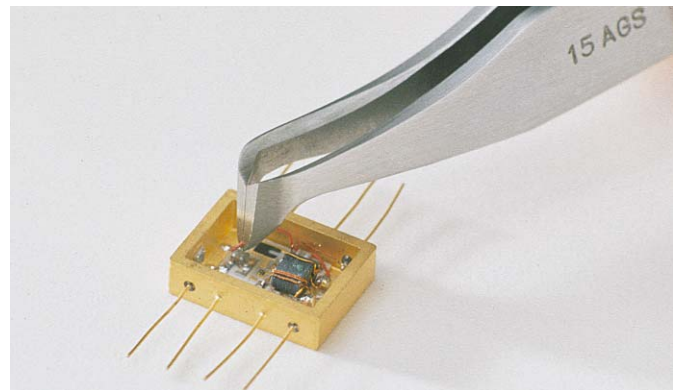

Cutting Tweezers
Main application:
e.g. for cutting soft wires
on micro electronics circuits,
very precise.



Model	Length	Weight	Description
15AGS	115 mm 	21 g	Anti-glare finish Cutting tweezers with fine oblique head and induction hardened cutting blades for increasing life time. For soft wires up to Ø 0,25 mm.
15AGW	115 mm 	26 g	Anti-glare finish Cutting tweezers with oblique head. Induction hardened cutting blades improves cutting capability and life time. For soft wires up to Ø 0,25 mm.

Stripping Tweezers

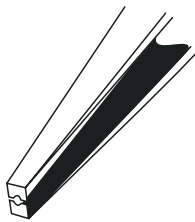

Stripping Tweezers
Main application:
for stripping small wires,
standard or PTFE, insulations,
very precise.

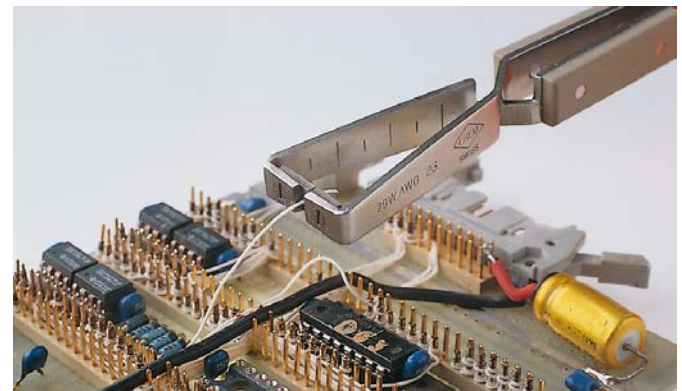

Model	Length	Weight	Description
29Y	120 mm	22 g	Stainless steel, anti-glare finish Miniature stripping tweezers. Serrated grips. Will strip tiny wires between AWG 42 and 32 (0,06 to 0,20 mm). Wire samples required.
29W30	120 mm	28 g	Stainless steel/fibre handles, anti-glare finish, reverse action Stripping tweezers with fibre-grip handles. For standard or PTFE, wires between AWG 30 and 28 (0,25 mm – 0,3 mm). Reverse action.

Extraction Tweezers

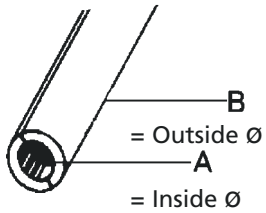

Extraction Tweezers
 Main application:
 to extract connected wires
 from the rear of the
 connectors.

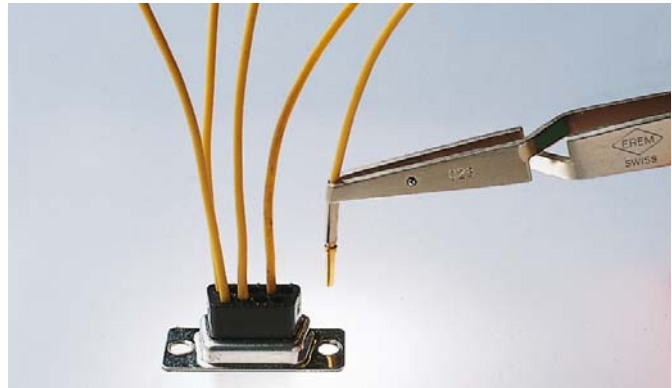

Model	Length	Ø A	Ø B	C	Weight	Description
024C	120 mm	1,75 mm	2,15 mm	8 mm	20 g	Stainless steel Extraction tweezers for Sub-D types. For ITT-Canon / TRW CET 20D, Honda connectors, Siemens, Philips, Souriau-Framatome, etc.
028	120 mm	1,9 mm	2,15 mm	8 mm	20 g	Stainless steel Same as 024C but with thinner nozzle wall for wires with larger insulations.

Cutters and Pliers

Erem Cutters and Pliers

Erem cutters and pliers are unique in the degree of quality, precision, reliability, ergonomics and long life they offer when compared to other professional tools, for the following reasons:



The Steel



Erem cutters and pliers are not forged. They are manufactured from billets of **high grade tool steel**, which uses a Swiss developed lamination technique. It employs a multiple extrusion process to super compact the steel imparting **additional strength** and toughness to the tools. This results in reliable and **long lasting** tools.

The Joints

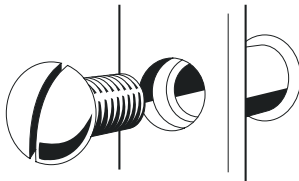

The surfaces between the two halves of the joint are machine finished and in conjunction with the interlocking precision screw that is used to join both halves together ensure **wobble free** operation and eliminates blade overlap which could cause mechanical shock and damage components.

The Springs

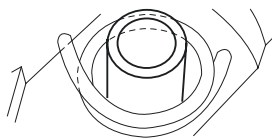

The return springs are mounted internally in the head of the tools and are guaranteed for **1 million operations**. They operate with a constant resistance over the movement of handles to reduce operator fatigue making them superior to leaf or coil springs.

EMOS

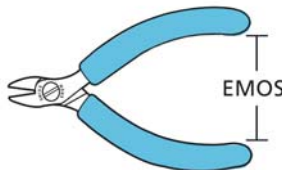

Erem **Maximum Opening Stop**, limits the handle spread by preventing the tips of the blades from opening more than 5mm. To promote operator comfort and ergonomics.

Cutters and Pliers

Customer Service



1. Spare parts

Erem pliers and cutters and their spare parts are guaranteed against manufacturing defects. The following parts will be supplied free of charge should a defect be found

- Foam grips
- Springs
- Opening stops

Please contact your local Cooper Hand Tools office for advice on procedure.



2. Resharpener

Erem cutters can be returned to Erem Switzerland for free of charge resharpener.

It is possible to resharpen tools up to three times depending on their condition.

Tools will be returned to you fitted with new handles depending on their shape.

You will be invoiced for transport costs only.

Specials



Erem is able to offer tools for special applications without minimum order quantity.

Dimensioned drawings /and or samples of your application will be required.

Ergonomic Handles

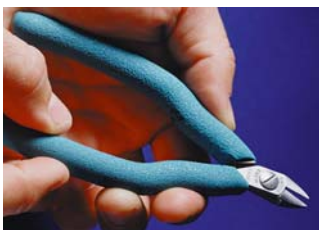

Erem Cutters and Pliers with Ergonomic Handles

The **Work Related Upper Limb Disorder (WRULD)** is a muscular skeletal problem related to the arm. WRULDS can be caused by positional fatigue or nerve damage caused e.g. by repetitive use of non ergonomic hand tools, the so-called **Repetitive Strain Injuries (RSI)**. The ability to grip and hold objects can be impaired. Repetitive movements can cause compression of the median nerve and produce sensations of pins and needles.

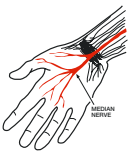

WRULDS is a direct result of companies manufacturing processes and working practices and will as result detrimental to the quality of a companies products. Therefore a reduction of the factors which cause WRULDS will improve working practice and product quality. In fact it is arguable that without quality working practice there can be no quality product.

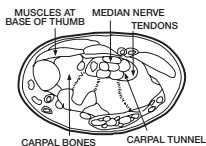

To alleviate the problem of RSI and Erem have designed a range of tools with ergonomic handles. The compound curves of the handles of the Erem ergonomic cutters and pliers allow the pressure applied to the handles when cutting or gripping to be evenly spread over the palm of the hand. The thumb and fingers are self- positioned by the handles, making the tool comfortable for the operator to use and reducing the incidence of WRULDS. The comfortable foam grips are ESD safe and easily interchangeable.



The following tools are available with ergonomic handles:

- **Side Cutters** see page 27 – 28
- **Tip Cutters** see page 33
- **Pliers** see page 39

Cutters and Pliers

ESD Safety

The foam cushion grips are static dissipative and are fitted a standard to all models.

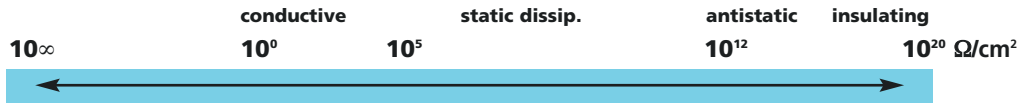

EMI/RF
Sources: DOD/CECC

Erem-Cutters + Pliers

Cost Per Cut Comparison

The best way to compare the real costs between different hand tools is to consider the number of cuts - besides the work itself and the performance. The parameters below indicate how Erem tools - representing a higher initial investment - become even more economical than lower quality cutters on a medium or long-term basis.

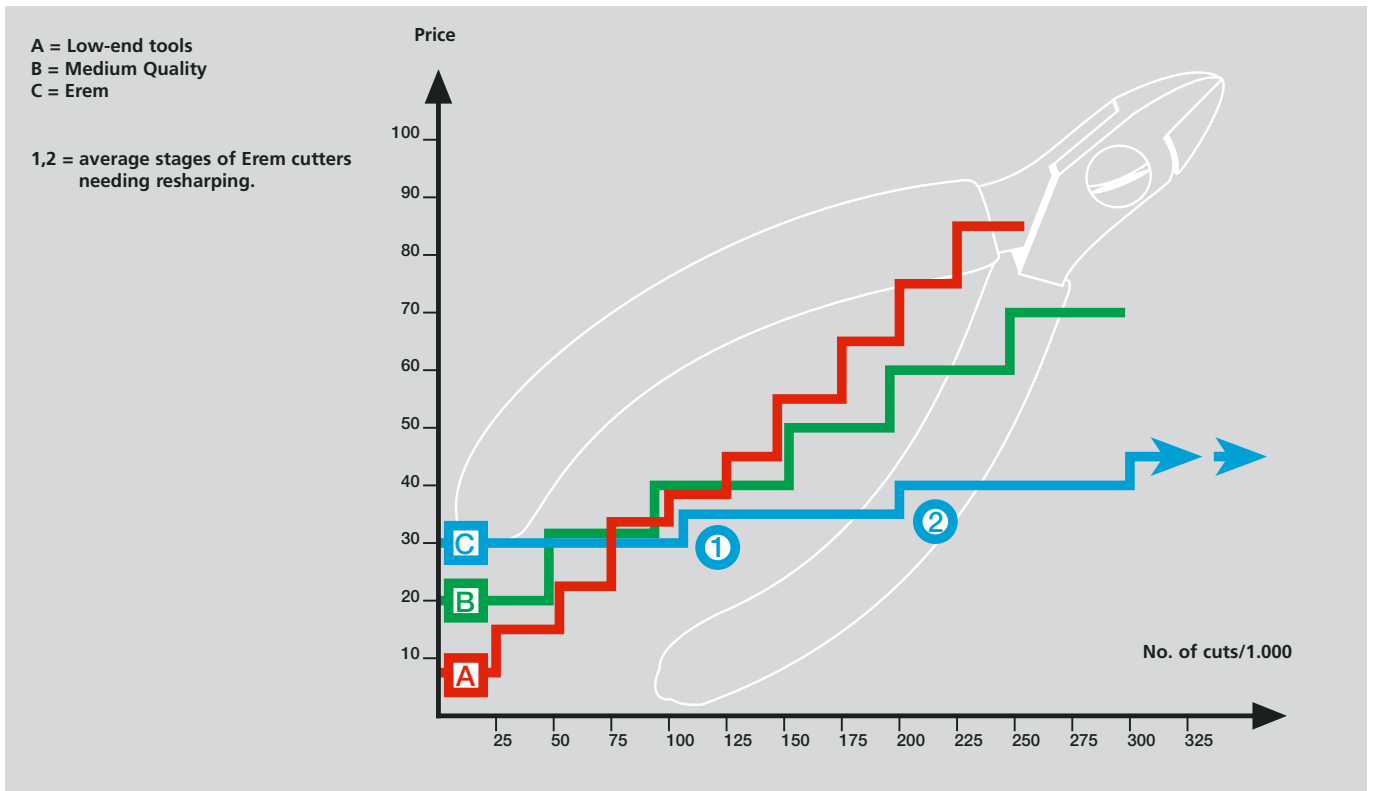

Cutting Capabilities

Side Cutters* Model	max. Cu (Copper) mm			Cut*		
	ø 0,1-0,6	ø 0,6-1,2	ø >1,2	SF	F	FF
147A	█	█	█	x		
511E	█	█	█	x		
512E	█	█	█	x		
512N	█	█	█	x		
521E	█	█			x	
522E	█	█			x	
522N	█	█	█		x	
532N	█	█	█			x
576EZ	█	█			x	
577E	█	█			x	
592E	█	█			x	
595E	█	█			x	
597E	█	█	█	x		
599E	█	█	█		x	
611E	█	█	█	x		
612E	█	█	█	x		
612N	█	█	█	x		
622N	█	█	█		x	
622NA	█	█			x	
622NB	█	█			x	
632N	█	█	█			x
676E	█	█			x	
677E	█	█			x	
710E	█	█				x
776E	█	█				x
792E	█	█				x
812N	█	█	█	x		
822N	█	█	█		x	
884E	█	█	█		x	
886E	█	█	█		x	
896E	█	█	█	x		
1512N	█	█	█	x		
1522N	█	█	█		x	
1522NA	█	█	█		x	
1522NB	█	█	█		x	
2212E	█	█	█	x		
2222E	█	█	█		x	
2222EA	█	█	█		x	
2222EB	█	█	█		x	
2232E	█	█	█			x

Tip Cutters* Model	max. Cu (Copper) mm			Cut*	
	ø 0,1-0,6	ø 0,6-1,2	ø >1,2	SF	F
503E	█	█			x
504AE	█	█			x
555E	█	█			x
570E	█	█			x
572E	█	█			x
573E	█	█			x
575E	█	█			x
582E	█	█			x
582EW	█	█			x
670E	█				x
1503N	█	█			x
2282E	█	█			x

 = Semi Flush

 = Flush

 = Erem Super Full Flush

Description see page 21

***Note:** There is no max. Cu indication for Tungsten Carbide cutters. Please ask for the according cutting capabilities.

Side Cutters

Side Cutters

Erem offers a wide range of precision side cutters. To establish which cutter is correct for your application follow the steps below

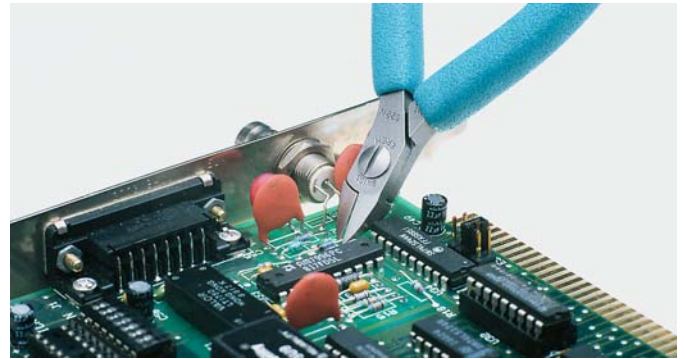

Head Form



Oval Head

The most common head shape. For standard cutting applications where access is not the problem.



Tapered Head

For cutting tasks where easier access is required. The tapered head shape allows better tip access than the oval head but without much reducing the cutting capability.



Relieved Head

For cutting in confined areas. This is the smallest head shape available. One side is cut away for access even in confined areas. Due to the cut away the cutting capability is reduced. Flush tip cutting.

Cut



Semi Flush

These blades allow a very high resistance. Will cut from tip to heel, malleable wires like Copper as well as hard wires. Leaves a pinch at the end of the wire. For all applications where the cutting type is not so important.



Flush

Allows a flat cut with the same cutting capacities. The edge of the wire is cut off flat. Thanks to faster penetration into the component the operator's effort is substantially reduced. No solder spikes after using wave soldering process.



Super Full Flush

An Erem exclusivity. This absolute full flush cut leaves a perfect flat surface on cut leads. It prevents any pinching of leads. Flat, clean cut. No cutting rework after soldering. Soft wires only.

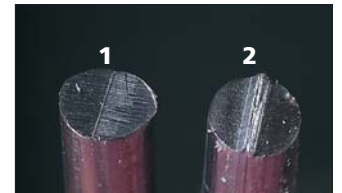

1. Erem Cut 2. Others

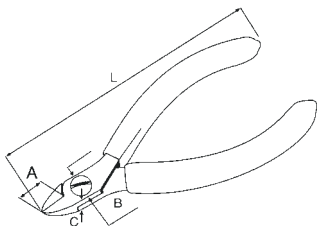

Size

110 mm Small short head for increased cutting resistance. For almost all cutting applications.

115 mm Longer and finer head. For cutting applications where easy access is more important than a high cutting capacity.

120 mm Strong version. For all cutting applications where high cutting capacity is required.



Safety Lead Device

Cutting safety device, holds wire scraps. Can be adapted on all side cutters series 500, 600 and 2200. Add "W" when ordering, e.g. 595EW

Oval Head



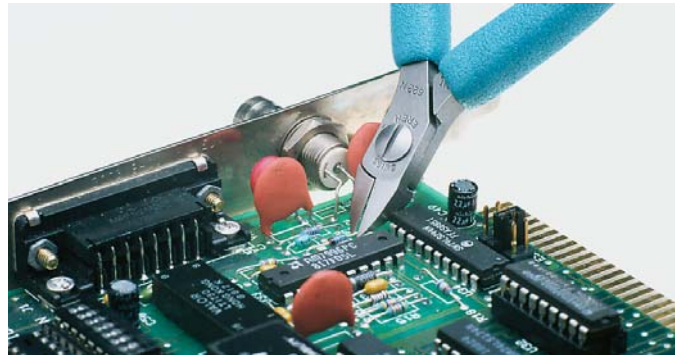
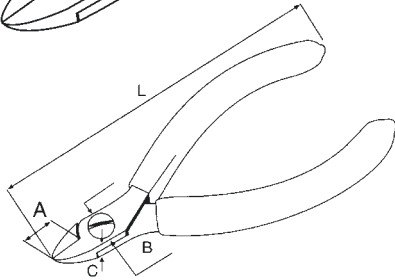

Oval Head
Main application:
standard cutting applications.













Length 110 mm

Model	L	A	B	C	Max. Cu	Weight	Description
 612N 	110 mm	9 mm	9 mm	6 mm	∅ 1,25 mm	48 g	Semi flush cut, high grade tool steel, burnished, ESD safe, resharpenable Miniature side cutter. Economical line. Small head.
 611E 	110 mm	9 mm	9 mm	6 mm	∅ 1,5 mm	48 g	Semi flush cut, high grade tool steel, burnished, ESD safe, resharpenable Miniature side cutter. Small head.
 612E 	110 mm	10,5 mm	9 mm	6 mm	∅ 1,5 mm	48 g	Semi flush cut, high grade tool steel, anti-glare finish, ESD safe, resharpenable Miniature side cutter. Standard head width.
 622N 	110 mm	9 mm	9 mm	6 mm	∅ 1,25 mm	48 g	Flush cut, high grade tool steel, anti-glare finish, ESD safe, resharpenable Miniature side cutter. Economical line. Small head.
 632N 	110 mm	9 mm	9 mm	6 mm	∅ 1,25 mm	48 g	Super full flush cut, high grade tool steel, anti-glare finish, ESD safe, resharpenable Miniature side cutter. Economical line. Small head. Perfect full flush cut. Soft wires only.
 710E 	110 mm	8,8 mm	9 mm	6 mm	∅ 1,0 mm	48 g	Super full flush cut, high grade tool steel, anti-glare finish, ESD safe, resharpenable Miniature side cutter. Standard head width. Perfect full flush cut. Soft wires only.

Length 115 mm

Model	L	A	B	C	Max. Cu	Weight	Description
 512N 	115 mm	10 mm	10,5 mm	6,5 mm	∅ 1,6 mm	67 g	Semi flush cut, high grade tool steel, anti-glare finish, ESD safe, resharpenable Side cutter for universal use. Medium size. Economical line.



Oval Head

Model	L	A	B	C	Max. Cu	Weight	Description
511E 	115 mm	10 mm	10,5 mm	6,5 mm	ø 1,6 mm	67 g	Semi flush cut, high grade tool steel, burnished, ESD safe, resharpenable Side cutter for universal use. Medium size.
512E 	115 mm	12 mm	10,5 mm	6,5 mm	ø 1,6 mm	67 g	Semi flush cut, high grade tool steel, burnished, ESD safe, resharpenable Side cutter for universal use. Medium size. For tough cutting applications.
597E 	115 mm	12 mm	10,5 mm	6,5 mm	ø 1,6 mm	67 g	Semi flush cut, high grade tool steel, anti-glare finish, ESD safe, resharpenable Side cutter with strong head. For soft and small hard wires.
599T 	115 mm	11,5 mm	10,5 mm	6,5 mm	ask for cutting capability*	67 g	Semi flush cut, Tungsten Carbide blades, anti-glare finish, ESD safe Side cutter with Tungsten Carbide blades for constant quality cuts. Resistant to small stainless steel wires.
599TFO 	115 mm	15 mm	10,5 mm	6,5 mm	ask for cutting capability*	67 g	Semi flush cut, Tungsten Carbide blades, anti-glare finish, ESD safe Side cutter with Tungsten Carbide blades. For cutting Vectran braided wires, fibre optics, Kevlar and small stainless steel braids. Ask for special application.
521E 	115 mm	10 mm	10,5 mm	6,5 mm	ø 1,2 mm	67 g	Flush cut, high grade tool steel, polished head, ESD safe, resharpenable Side cutter for universal use. Medium size.
522N 	115 mm	10 mm	10,5 mm	6,5 mm	ø 1,6 mm	67 g	Flush cut, high grade tool steel, anti-glare finish, ESD safe, resharpenable Side cutter for universal use. Medium size. Economical line.
522E 	115 mm	12 mm	10,5 mm	6,5 mm	ø 1,2 mm	67 g	Flush cut, high grade tool steel, polished head, ESD safe, resharpenable Side cutter for universal use.
599E 	115 mm	12 mm	10,5 mm	6,5 mm	ø 1,6 mm	67 g	Flush cut, high grade tool steel, anti-glare finish, ESD safe Side cutter with robust head.
599TF 	115 mm	11,5 mm	10,5 mm	6,5 mm	ask for cutting capability*	67 g	Flush cut, Tungsten Carbide blades, anti-glare finish, ESD safe Side cutter with Tungsten Carbide blades for constant quality cuts. Resistant to small stainless steel wires.
532N 	115 mm	10 mm	10,5 mm	6,5 mm	ø 1,6 mm	67 g	Super full flush cut, high grade tool steel, anti-glare finish, ESD safe, resharpenable Side cutter for universal use. Medium size. Economical line. Perfect full flush cut. Soft wires only.

* Please provide wire sample.

Oval Head

Length 120 mm



Model	L	A	B	C	Max. Cu	Weight	Description
 <p>812N</p>	120 mm	15 mm	13,5 mm	7,5 mm	∅ 1,8 mm	85 g	Semi flush cut, high grade tool steel, anti-glare finish, ESD safe, resharpenable Side cutter for large wires. Economical line.
 <p>896E</p>	120 mm	15 mm	13,5 mm	7,5 mm	∅ 1,8 mm	85 g	Semi flush cut, high grade tool steel, anti-glare finish, ESD safe, resharpenable Side cutter for hard leads, Kovar wires, connector pins, etc.
 <p>822N</p>	120 mm	15 mm	13,5 mm	7,5 mm	∅ 1,8 mm	85 g	Flush cut, high grade tool steel, anti-glare finish, ESD safe, resharpenable Side cutter for large wires. Economical line.

Tapered Head



Tapered Head
 Main application:
 cutting applications where
 easy access is required.

Length 110 mm

Model	L	A	B	C	Max. Cu	Weight	Description
 <p>622NA</p>	110 mm	9 mm	9 mm	6 mm	∅ 1,0 mm	48 g	Flush cut, high grade tool steel, anti-glare finish, ESD safe, resharpenable Miniature side cutter. Small tapered head allows very good access. Economical line.
 <p>677E</p>	110 mm	9 mm	9 mm	6 mm	∅ 1,0 mm	48 g	Flush cut, high grade tool steel, anti-glare finish, ESD safe, resharpenable Miniature side cutter. Small tapered head allows very good access.



Length 115 mm

Model	L	A	B	C	Max. Cu	Weight	Description
 <p>595T</p>	115 mm	12 mm	10,5 mm	6,5 mm	ask for cutting capability*	67 g	Semi flush cut, Tungsten Carbide blades, anti-glare finish, ESD safe Side cutter with Tungsten Carbide blades for constant quality cuts. Resistant to small stainless steel wires. Ask for special application.

* Please provide wire sample.

Tapered Head

Length 115 mm

Model	L	A	B	C	Max. Cu	Weight	Description
 577E	115 mm	9 mm	10,5 mm	6,5 mm	ø 1,2 mm	67 g	Flush, high grade tool steel, anti-glare finish, ESD safe, resharpenable Side cutter for universal use. Medium size.
 595E	115 mm	9 mm	10,5 mm	6,5 mm	ø 1,2 mm	67 g	Flush, high grade tool steel, anti-glare finish, ESD safe, resharpenable Side cutter for universal use. Medium size.
 595TF	115 mm	12 mm	10,5 mm	6,5 mm	ask for cutting capability*	67 g	Flush cut, Tungsten Carbide blades, anti-glare finish, ESD safe Side cutter with Tungsten Carbide blades for constant quality cuts. Resistant to small stainless steel wires.

* Please provide wire sample.

Length 120 mm

Model	L	A	B	C	Max. Cu	Weight	Description
 886E	120 mm	15 mm	13,5 mm	7,5 mm	ø 1,8 mm	83 g	Flush, high grade tool steel, anti-glare finish, ESD safe, resharpenable Side cutter for large wires.

Relieved Head

**Relieved Head**



Main application:
cutting applications
in confined areas.

Length 110 mm

Model	L	A	B	C	Max. Cu	Weight	Description
 662NB	110 mm	9 mm	9 mm	6 mm	ø 0,8 mm	48 g	Flush, high grade tool steel, anti-glare finish, ESD safe, resharpenable Miniature side cutter. Super fine relieved head allows very good access. Economical line.





Relieved Head

Length 110 mm

Model	L	A	B	C	Max. Cu	Weight	Description
 <p>676E</p>	110 mm	9 mm	9 mm	6 mm	∅ 1,0 mm	48 g	<p>Flush cut, high grade tool steel, anti-glare finish, ESD safe, resharpenable</p> <p>Miniature side cutter. Super fine relieved head allows very good access.</p>
 <p>776E</p>	110 mm	9 mm	9 mm	6 mm	∅ 1,0 mm	48 g	<p>Super full flush cut, high grade tool steel, anti-glare finish, ESD safe, resharpenable</p> <p>Miniature side cutter. Super fine relieved head allows very good access. Soft wires only.</p>
 <p>632NCF</p>	110 mm	9 mm	9 mm	6 mm	ask for cutting capability*	48 g	<p>Super full flush cut, high grade tool steel, anti-glare finish, ESD safe, soft materials only</p> <p>Miniature side cutter. Special fine, high precision cut exclusively designed for soft materials like small Silicone tubing in medical applications, precision connector sealing, miniature rubber gaskets or cutting of molded soft synthetic parts. Super fine relieved head allows very good access.</p>

* Please provide wire sample.

Length 115 mm



Model	L	A	B	C	Max. Cu	Weight	Description
 <p>576Z</p>	115 mm	9 mm	10,5 mm	6,5 mm	∅ 1,2 mm	67 g	<p>Flush cut, high grade tool steel, anti-glare finish, ESD safe, resharpenable</p> <p>Side cutter with fine relieved head. Medium size. For fine wires.</p>
 <p>592E</p>	115 mm	12 mm	10,5 mm	6,5 mm	∅ 0,6 mm	67 g	<p>Flush cut, high grade tool steel, anti-glare finish, ESD safe, resharpenable</p> <p>Side cutter with relieved head. Medium size. For Copper wires.</p>
 <p>576TX</p>	115 mm	11 mm	10,5 mm	6,5 mm	ask for cutting capability*	67 g	<p>Flush cut, Tungsten Carbide blades, anti-glare finish, ESD safe</p> <p>Miniature side cutter. Super fine relieved head allows very good access. Tungsten Carbide blades for constant quality cuts. Resistant to small stainless steel wires.</p>
 <p>792E</p>	115 mm	13 mm	10,5 mm	6,5 mm	∅ 0,6 mm	67 g	<p>Super full flush cut, high grade tool steel, anti-glare finish, ESD safe, resharpenable</p> <p>Side cutter with relieved head. Medium size. For fine soft wires.</p>

Length 120 mm

Model	L	A	B	C	Max. Cu	Weight	Description
 <p>884E</p>	120 mm	15 mm	13,5 mm	7,5 mm	∅ 1,8 mm	81 g	<p>Flush cut, high grade tool steel, anti-glare finish, ESD safe, resharpenable</p> <p>Side cutter for large wires.</p>

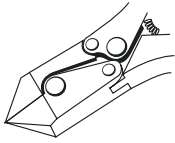
Specials







Model	L	A	B	C	Max. Cu	Weight	Description
 <p>147A</p>	120 mm	12 mm	10,5 mm	7,5 mm	∅ 2,0 mm	100 g	<p>Semi flush cut, high grade tool steel, anti-glare finish, ESD safe, compound action</p> <p>Compound action side cutter. Easy cutting for hard wires. 3,5 times less force needed than with conventional cutters. High cutting capacity: hard wires up to 0,5 mm, soft wires up to 2,0 mm. Flush cut on request.</p>
 <p>884EPCM</p>	115 mm	max.D 0,8 mm max.B 2,0 mm			-	79 g	<p>Flush cut, high grade tool steel, anti-glare finish, ESD safe, PCB separation</p> <p>Side cutter for PCB separation only. New improved design for higher blade resistance. No breakage guarantee.</p>

Side Cutters with Ergonomic Handles*

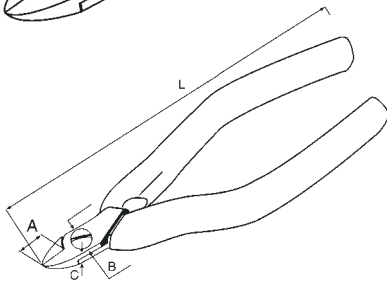

Oval Head
Main applications:
Constant production cutting applications.



Model	L	A	B	C	Max. Cu	Weight	Description
 <p>2212E</p>	140 mm	10 mm	10 mm	5,8 mm	∅ 1,25 mm	70 g	<p>Semi flush cut, high grade tool steel, anti-glare finish, ESD safe, resharpenable, Ergonomic</p> <p>Ergonomic side cutter for universal use.</p>
 <p>2222E</p>	140 mm	10 mm	10 mm	5,8 mm	∅ 1,25 mm	70 g	<p>Flush cut, high grade tool steel, anti-glare finish, ESD safe, resharpenable, Ergonomic</p> <p>Ergonomic side cutter for universal use.</p>
 <p>2232E</p>	140 mm	10 mm	10 mm	5,8 mm	∅ 1,25 mm	70 g	<p>Super full flush cut, high grade tool steel, anti-glare finish, ESD safe, resharpenable, Ergonomic</p> <p>Ergonomic side cutter for fine and soft wires.</p>

*Ergonomic features see page 18

Tapered Head



Tapered Head

Model	L	A	B	C	Max. Cu	Weight	Description
 2222EA	140 mm	10 mm	10 mm	5,8 mm	ø 1,0 mm	70 g	Flush, high grade tool steel, anti-glare finish, ESD safe, resharpenable, Ergonomic Ergonomic side cutter for universal use. Tapered head for easier access.

Relieved Head



Relieved Head

Model	L	A	B	C	Max. Cu	Weight	Description
 2222EB	140 mm	10 mm	10 mm	5,8 mm	ø 0,8 mm	70 g	Flush, high grade tool steel, anti-glare finish, ESD safe, resharpenable, Ergonomic Ergonomic side cutter for universal use. Relieved head for working in confined areas.

Tip Cutters

Erem offers the largest variety of high precision tip cutters. All edges are finely radiused to avoid board damaging. To find the cutter for your demand just follow the steps

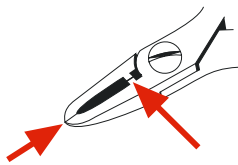
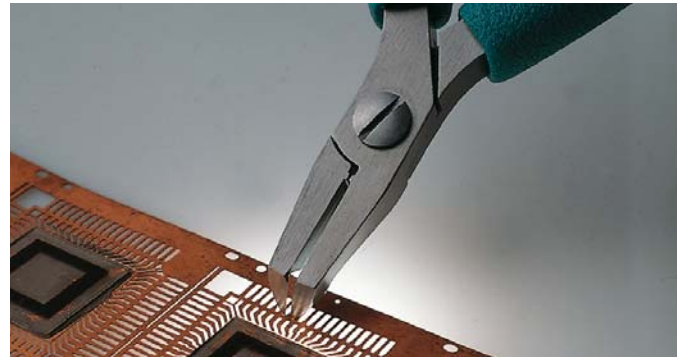

Erem Blade Protection

All tip cutters have an "anti-overbite" system which prevents blades from overlapping.

Head Form

Angled

For standard tip cutting applications.



Angled Narrow

For applications in confined areas. Longer but narrow head for better reach between parts and into areas with limited access.

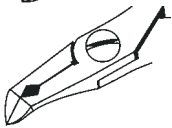

Straight

For vertical or horizontal tip cutting applications.

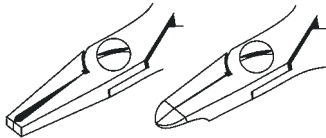

Cut

Semi Flush

These blades allow a very high resistance. Will cut malleable wires like Copper as well as hard wires. Leaves a pinch at the end of the wire.



Flush

Allow a flat cut with high cutting capacities. The edge of the wire is cut off almost squarely. Guaranteed precision even after constant usage. Thanks to faster penetration into the component the operator's effort is substantially reduced.

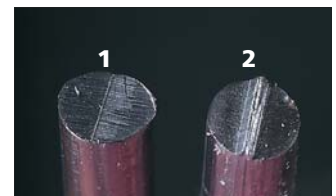

1. Erem Cut 2. Others

Size

110 mm Small short head, for increased cutting resistance. For almost all cutting applications.

115 mm Longer and finer head. For cutting applications where easy access is more important than a high cutting capacity.

120 mm Strong version. For all cutting applications where high cutting capacity is required.

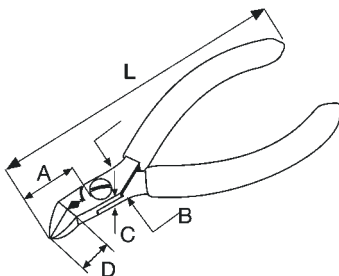

Safety Lead Device

Cutting safety device, holds wire scraps. Can be adapted on 582E only. Add "W" when ordering, e.g. 582EW.



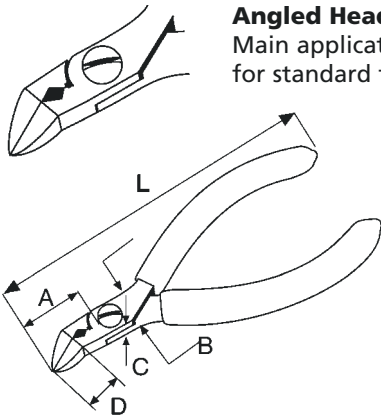

Angled Head

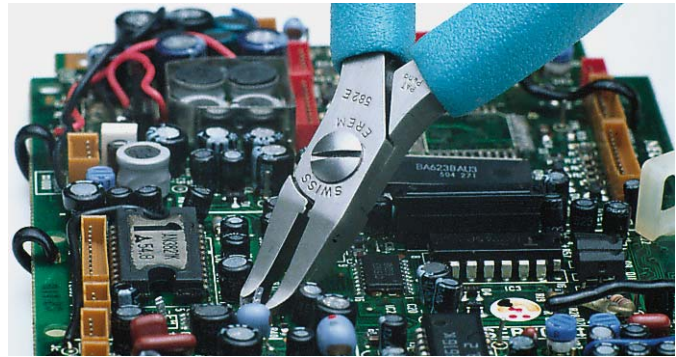

Angled Head
Main application:
for standard tip cutting applications.



Length 110 mm

Model	L	A	B	C	D	Max. Cu	Weight	Description
 503ET	110 mm	12 mm	10,5 mm	6,5 mm	10 mm	ask for cutting capability*	67 g	± 30°, semi flush cut, Tungsten Carbide, anti-glare finish, ESD safe Tip cutter. Standard size. Tungsten Carbide blades for constant quality cuts even on hard wires.
 503E	110 mm	12 mm	10,5 mm	6,5 mm	10 mm	∅ 1,2 mm	67 g	± 30°, flush cut, high grade tool steel, anti-glare finish, ESD safe, resharpenable Tip cutter. Standard size. For universal use.
 504AE	110 mm	13 mm	10,5 mm	6,5 mm	10 mm	∅ 1,2 mm	67 g	± 30°, flush cut, high grade tool steel, anti-glare finish, ESD safe, resharpenable Tip cutter. Standard size. Rounded head. For universal use.
 503ETF	110 mm	12 mm	10,5 mm	6,5 mm	10 mm	ask for cutting capability*	67 g	± 30°, flush cut, Tungsten Carbide blades, anti-glare finish, ESD safe Tip cutter. Standard size. Tungsten Carbide blades for constant quality cuts even on hard wires.

* Please provide wire sample.

Angled Head Small

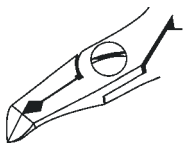









Angled Head Small
Main applications:
for applications in confined areas.

Length 110 mm



Model	L	A	B	C	D	Max. Cu	Weight	Description
 575E	110 mm	15 mm	10,5 mm	6,5 mm	10 mm	∅ 0,6 mm	67 g	± 45°, flush cut, high grade tool steel, anti-glare finish, ESD safe, resharpenable Tip cutter. Small size. For delicate work on hybrid circuits or micro modules.

Angled Head Small

Length 115 mm

Model	L	A	B	C	D	Max. Cu	Weight	Description
 572E 	115 mm	18 mm	10,5 mm	6,5 mm	6,5 mm	ø 0,6 mm	68 g	✂ 40°, flush cut, high grade tool steel, anti-glare finish, ESD safe, resharpenable Tip cutter. Medium size. Relieved jaws for easier access.
 593AE 	115 mm	20 mm	10,5 mm	6,5 mm	4 mm	ø 1,0 mm	68 g	✂ 50°, flush cut, high grade tool steel, anti-glare finish, ESD safe, resharpenable Tip cutter. Cuts easily DIL leads from the rear. Cuts pins on dense PCB. Ideal maintenance tool.
 582E 	115 mm	19 mm	10,5 mm	6,5 mm	7 mm	ø 1,0 mm	68 g	✂ 45°, flush cut, high grade tool steel, anti-glare finish, ESD safe, resharpenable Tip cutter medium size. A must when working on PCB's, cutting component leads. Also ideal for rework.
 582EW 	115 mm	19 mm	10,5 mm	6,5 mm	7 mm	ø 1,0 mm	70 g	✂ 45°, flush cut, high grade tool steel, anti-glare finish, ESD safe, resharpenable, retention clip Same as 582E but with retention clip, holds wire scraps after cutting.

Length 120 mm

Model	L	A	B	C	D	Max. Cu	Weight	Description
 555E 	120 mm	21 mm	10,5 mm	6 mm	6,5 mm	ø 1,2 mm	68 g	✂ 40°, flush cut, high grade tool steel, anti-glare finish, ESD safe, resharpenable Tip cutter. Strong version.

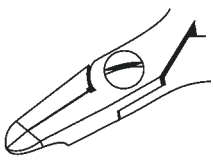

Straight Tapered Head

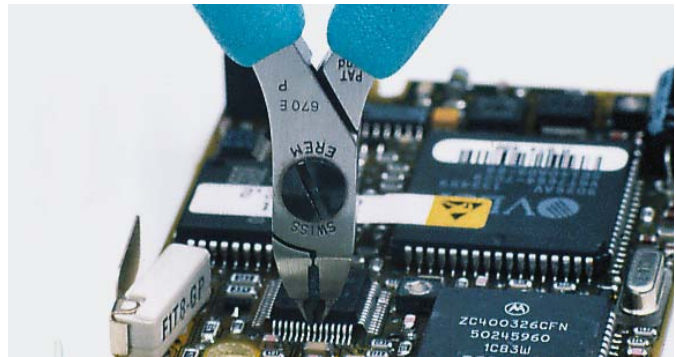
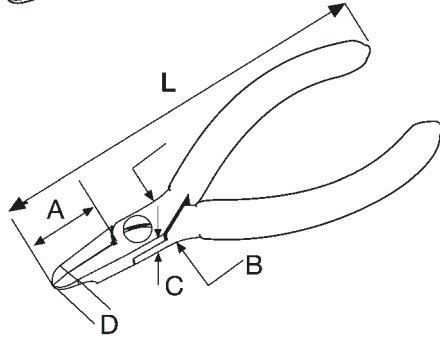

Straight Tapered Head
Main applications:
for horizontal use and easier access.



Length 110 mm

Model	L	A	B	C	D	Max. Cu	Weight	Description
 670E	110 mm	10,5mm	9 mm	6 mm	3 mm	ø 0,6 mm	48 g	Horizontal, flush cut, high grade tool steel, anti-glare finish, ESD safe, resharpenable Miniature tip cutter. For cutting small wires in dense working areas. Vertical SMD cutter.
 670EP	110 mm	10 mm	9 mm	6 mm	2 mm	ø 0,25 mm	48 g	Vertical tip cutter, flush cut, high grade tool steel, anti-glare finish, ESD safe, resharpenable Miniature tip cutter. High precision SMD lead cutting. Micro-packages up to 0,25 fine pitches before desoldering. No breakage guarantee. For µ-pitches under 0,5 mm use 670 EPF

Length 120 mm

Model	L	A	B	C	D	Max. Cu	Weight	Description
 570E	120 mm	22 mm	9 mm	6,5 mm	4 mm	ø 0,6 mm	67 g	Flush cut, high grade tool steel, anti-glare finish, ESD safe, resharpenable Tip cutter for horizontal or vertical tip cutting. For cutting at extreme tips.

Straight Head

Straight Head
Main applications:
for vertical use

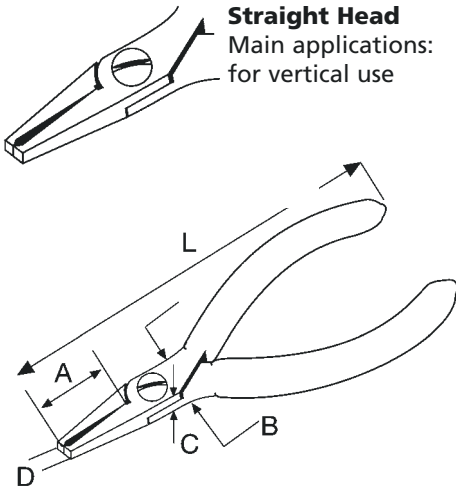

Model	L	A	B	C	D	Max. Cu	Weight	Description
573E 	120 mm	23 mm	9 mm	6,5 mm	3,5 mm	ø 0,8 mm	67 g	Vertical, flush cut, high grade tool steel, anti-glare finish, ESD safe, resharpenable Tip cutter for vertical tip cutting. For fine wires.

Tip Cutters with Ergonomic Handles*

Angled Head Small

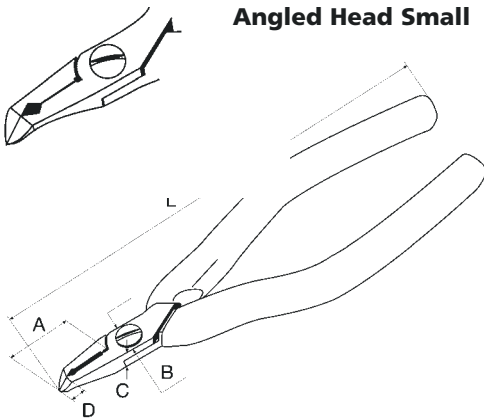

Model	L	A	B	C	D	Max. Cu	Weight	Description
2282E 	140 mm	20 mm	10 mm	5,8 mm	7 mm	ø 1,0 mm	70 g	45°, flush cut, high grade tool steel, anti-glare finish, ESD safe, resharpenable, ergonomic Ergonomic tip cutter. Medium size. Ideal for working on PCB's or cutting component leads.

*Ergonomic features see page 18

Pneumatic Side Cutters and Tip Cutters

Pneumatic Side Cutters and Tip Cutters

The Erem 1500BSF is a small lightweight air tool that can be fitted with a range of cutter heads making this tool extremely versatile. It is suitable for the cropping of conventional components, as well as small ductile or plastic parts.

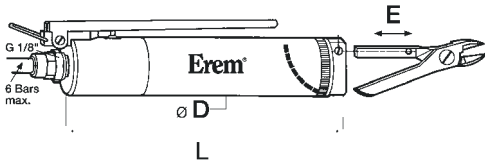

Housing

Model	D	L	Weight	Description
1500BSF	28 mm	130 mm (w.o. head)	130 g	Manual air tool Small precise pneumatic cutter housing. Improved lifetime and reliability. Easy interchangeable cutting heads. Requires 4- 6 bar oil-free, clean compressed air. New economical version.

Cutting Heads for 1500BSF

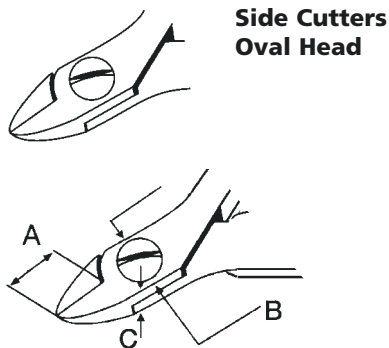

Model	A	B	C	Max. Cu	Weight	Description
1512N	10 mm	10,5 mm	6,5 mm	ø 1,6 mm	35 g	Semi flush cut, high grade tool steel, anti-glare finish, resharpenable Side cutter for universal use. Medium size. Economical line. Improved lifetime.
1522N	10 mm	10,5 mm	6,5 mm	ø 1,6 mm	35 g	Flush cut, high grade tool steel, anti-glare finish, resharpenable Side cutter for universal use. Medium size. Economical line. Improved lifetime.

Tapered Head



Tapered Head

Model	A	B	C	Max. Cu	Weight	Description
1522NA 	9 mm	10,5 mm	6,5 mm	∅ 1,4 mm	35 g	Flush cut, high grade tool steel, anti-glare finish, resharpenable Side cutter for easier access. Medium size. Economical line. Improved lifetime.



Relieved Head

Model	A	B	C	Max. Cu	Weight	Description
1522NB 	9 mm	10,5 mm	6,5 mm	∅ 1,2 mm	32 g	Flush cut, high grade tool steel, anti-glare finish, resharpenable Side cutter for confined areas. Medium size. Economical line. Improved lifetime.

Tip Cutters

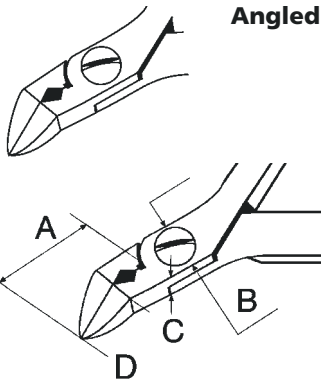

Angled Head

Model	A	B	C	D	Max. Cu	Weight	Description
1503E 	12 mm	10,5 mm	6,5 mm	9 mm	∅ 1,2 mm	38 g	∠ 30°, flush cut, high grade tool steel, anti-glare finish, resharpenable Tip cutter. Small size. For universal use.

Note: further head shapes available on request.

Distance Cutters

Distance Cutters

Erem distance cutters are available with fixed or adjustable cutting distance. The tips are brightly polished to avoid board damage

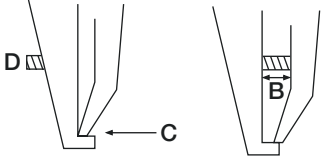
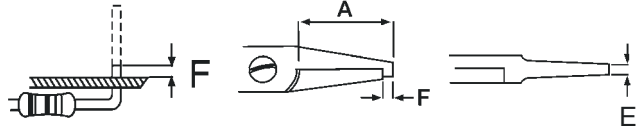

The Erem protective stop screw increases the performance of the tip cutters:
 Clearance B larger than the diameter = cut wire is ejected
 Clearance B smaller than the wire diameter = cut wire is held
 Adjust the protective stop screw D to set blade C does not hit the opposite side.
 This improves the Lifetime of the blade.

Fixed Cutting Height

Model	L	A	E	F	Max. Cu	Weight	Description
530E	120 mm	20 mm	3 mm	1,5 mm (Standard)	ø 1,0 mm	67 g	Flush cut, high grade tool steel, polished tips, ESD safe Distance cutter. Cuts the lead to a predetermined length of 1,5 mm. Length from 0,5 mm to 2,5 mm on request, see price list. Reduces mechanical shock on components. With adjustable screw for possible wire holding.
549E	115 mm	20 mm	3 mm blade 4,5 mm	1,5 mm (Standard)	ø 1,0 mm	67 g	45°, flush cut, high grade tool steel, polished tips, ESD safe Distance cutter. Cuts the lead to a predetermined length of 1,5 mm. Length from 0,5 mm to 2,5 mm on request, see price list. Reduces mechanical shock on components.
500-108	120 mm	20 mm	3 mm	1,5 mm	ø 0,8 mm	67 g	Flush cut, high grade tool steel, polished tips, ESD safe Distance cutter. Cuts the lead to a predetermined length of 1,5 mm. Reduces mechanical shock on components.
530S	110 mm	10 mm	4 mm	1,5 mm (Standard)	ø 1,0 mm	65 g	30°, flush cut, high grade tool steel, polished tips, ESD safe Distance cutter. Cuts and flattens leads to prevent component from fallen off the circuit board. Predetermined length of 1,5 mm. Length from 0,5 mm to 2,5 mm on request.

Adjustable Cutting Height

Model	L	A	E	F	Max. Cu	Weight	Description
530E15A	120 mm	20 mm	4,5 mm	1,2 - 6 mm	ø 1,2 mm	70 g	Flush cut, high grade tool steel, polished tips, ESD safe Distance cutter with adjustable cutting length from 1,2 mm to 6 mm with setting screw.
573EB	115 mm	23 mm	3,5 mm	0-5 mm	ø 0,8 mm	70 g	Flush cut, Plastic anvil. High grade tool steel, polished tips, ESD safe Distance cutter with adjustable cutting length from 0 mm to 5 mm with setting screw. Replaceable synthetic stop, no risk of board damage.

Pliers

Erem offer a range of pliers with standard and ergonomic handles.

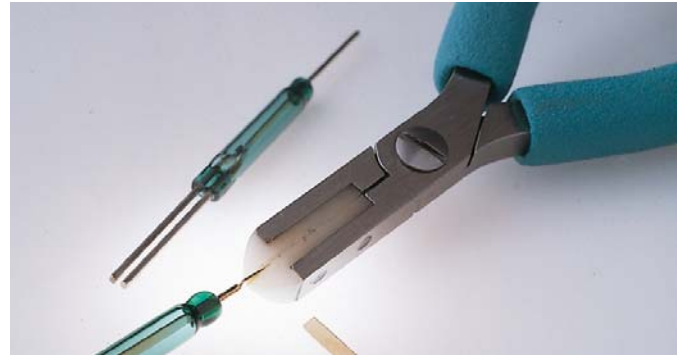
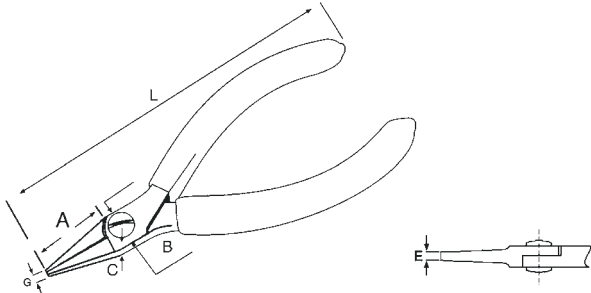



Round Nose

Model	L	A	B	C	E ∅	G	Weight	Description
 543E	120 mm	23 mm	9 mm	6,5 mm	0,8 mm	1,6 mm	67 g	High grade tool steel, anti-glare finish, ESD safe Round nose pliers with smooth jaws, very precise.

Needle Nose



Model	L	A	B	C	E	G	Weight	Description
 547	120 mm	23 mm	9 mm	6,5 mm	0,9 mm	1,2 mm	67 g	High grade tool steel, anti-glare finish, ESD safe Needle nose pliers with smooth jaws, very precise.

Flat Nose

Model	L	A	B	C	E	G	Weight	Description
 542E	120 mm	23 mm	9 mm	6,5 mm	2,4 mm	1,4 mm	67 g	High grade tool steel, anti-glare finish, ESD safe Flat nose pliers with smooth jaws.
 531E	125 mm	23 mm	9 mm	6,5 mm	5 mm	3 mm	67 g	High grade tool steel/Nylon, anti-glare finish, ESD safe Flat nose pliers with replaceable Nylon inserts to prevent nicking e.g. for straightening precious metal, leads, etc.

Pliers

Chain Nose

Model	L	A	B	C	E	G	Weight	Description
 <p>544E</p>	120 mm	23 mm	9 mm	6,5 mm	1 mm	1,4 mm	67 g	High grade tool steel, anti-glare finish, ESD safe Chain nose pliers with smooth jaws.
 <p>544D</p>	125 mm	23 mm	9 mm	6,5 mm	1 mm	1,4 mm	67 g	High grade tool steel, anti-glare finish, ESD safe Chain nose pliers with smooth jaws, inside serrated.
 <p>546E</p>	125 mm	24 mm	9 mm	6,5 mm	0,8 mm	0,8 mm	67 g	\sphericalangle 60°, high grade tool steel, anti-glare finish, ESD safe Chain nose pliers bent with smooth jaws. D = 6,0 mm

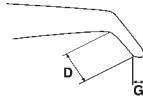

Pliers with Ergonomic Handles*

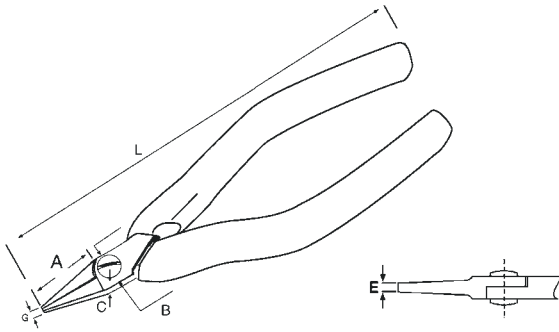

Needle Nose

Model	L	A	B	C	E	G	Weight	Description
2211P 	165 mm	35 mm	10 mm	5,8 mm	1 mm	1,2 mm	80 g	High grade tool steel, anti-glare finish, ESD safe, Ergonomic Ergonomic needle nose pliers with smooth jaws.

Flat Nose

Model	L	A	B	C	E	G	Weight	Description
2242E 	160 mm	33 mm	10 mm	5,8 mm	3,5 mm	1,5 mm	80 g	High grade tool steel, anti-glare finish, ESD safe, Ergonomic Ergonomic flat nose pliers with long smooth jaws. Precise radiused edges.

*Ergonomic features see page 18



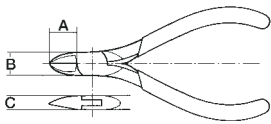

EROP Cutters and Pliers

EROP Cutters and Pliers

The newly introduced EROP range from Erem offers a variety of side cutters and pliers at a budget price. The tools are manufactured from high quality tool steel have a box joint construction, burnished heads, robust opening leaf springs and replaceable soft ESD safe grips.



Side Cutters

Model	L	A	B	C	Max. Cu	Weight	Description
 EROP355	110 mm	11 mm	9,5 mm	7,5 mm	ø 1,0 mm	61 g	Semi flush cut, high quality tool steel, burnished, ESD safe Side cutter, tapered head, slim-line. Fine cutting edges for fine work.
 EROP155	110 mm	13,5 mm	11 mm	7,5 mm	ø 1,0 mm	72 g	Semi flush cut, high quality tool steel, burnished, ESD safe Side cutter, round head. For assembly work on circuit boards, telephone and radio work.
 EROP419	130 mm	18 mm	11 mm	8 mm	ø 2,0 mm	110 g	Semi flush cut, high quality tool steel, burnished, ESD safe Side cutter robust. Round head. For general use.
 EROP357	110 mm	11 mm	9,5 mm	7,5 mm	ø 0,6 mm	61 g	Semi flush cut, high quality tool steel, burnished, ESD safe Side cutter, tapered head, slim-line. Fine cutting edges for cutting thin wires and cutting tiny components.

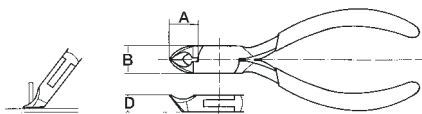

Tip Cutters

Model	L	A	B	D	Max. Cu	Weight	Description
 EROP331	120 mm	12 mm	12 mm	7,5 mm	ø 1,5 mm	81 g	± 40°, flush cut, high quality tool steel, burnished, ESD safe Tip cutter bent, slim. Ideal for fine works. Exact guidance of cutting edges.

EROP Cutters

Model	L	A	B	D	Max. Cu	Weight	Description
 EROP330	130 mm	7,5 mm	7,5 mm	5,0 mm	∅ 1,0 mm	84 g	✂ 40°, flush cut, high quality tool steel, burnished, ESD safe Tip cutter bent. For PCB applications.

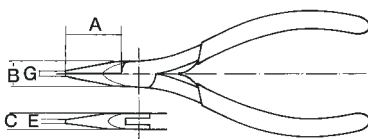

EROP Pliers



Round Nose



Model	L	A	B	C	E ∅	G	Weight	Description
 EROP172	125 mm	22,5 mm	9,5 mm	6 mm	0,8 mm	1,6 mm	63 g	High quality tool steel, burnished, ESD safe Round nose pliers. Smooth polished inside jaws for bending fine loops.

Needle Nose

Model	L	A	B	C	E	G	Weight	Description
 EROP174	120 mm	22,5 mm	9,5 mm	6,5 mm	1,5 mm	2 mm	66 g	High quality tool steel, burnished, ESD safe Needle nose pliers. Smooth polished inside jaws for gripping fine parts and forming wire.
 EROP277	140 mm	39 mm	12 mm	7,5 mm	1,2 mm	1,8 mm	90 g	High quality tool steel, burnished, ESD safe Needle nose pliers. Serrated, for gripping, holding and forming wires and parts.
 EROP280	170 mm	64 mm	13,5 mm	8 mm	1,8 mm	2 mm	113 g	High quality tool steel, burnished, ESD safe Needle nose pliers long. Oval pointed. Serrated. Robust but fine tips for work in confined areas.

EROP Pliers

Flat Nose

Model	L	A	B	C	E	G	Weight	Description
 <p>EROP170</p>	120 mm	22,5 mm	9,5 mm	6 mm	3 mm	1,2 mm	63 g	High quality tool steel, burnished, ESD safe Flat nose pliers. Slim smooth jaws for delicate work.
 <p>EROP171</p>	120 mm	22,5 mm	9,5 mm	6 mm	4 mm	1,2 mm	67 g	High quality tool steel, burnished, ESD safe Flat nose pliers. Slim smooth jaws for delicate work. With larger gripping area.

Stripping Tools

High Precision Stripping Tools

Erem stripping tools are the most precise tools used in the electronic or aviation field. They are manufactured from high grade tool steel to ensure durability. To ensure that you have the correct tool for your application, send us samples of your wire and we will make recommendations.

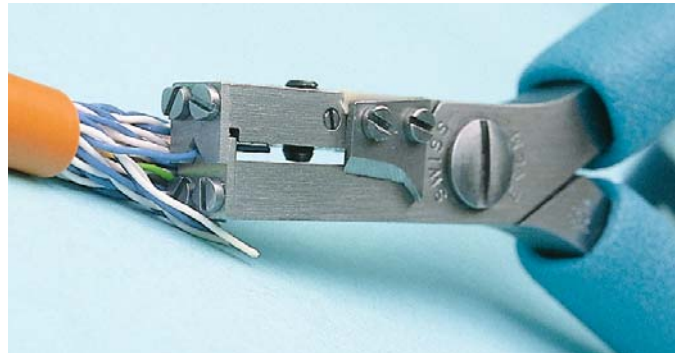

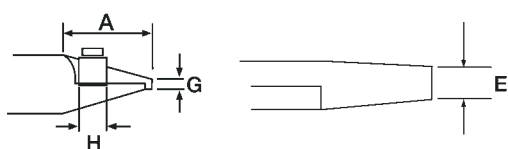

Front Stripping

Model	L	A	E	G	H	Wire \varnothing	Weight	Description
 <p>510AE</p>	120 mm	21 mm	5 mm	4 mm	7 mm	0,25 - 1,02 mm (AWG 30 - 18)	75 g	High grade tool steel, anti-glare finish, ESD safe Front stripping tool. Adjustable for different diameters. Diameter adjustable with screw. With interchangeable side cutting blade. For all kind of insulation and fibre optic outer jackets.
								

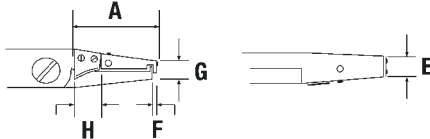
Stripping Tools

Model	L	A	E	F	G	H	Wire \varnothing	Weight	Description
 <p>552E</p>	120 mm	23 mm	6,5 mm	1 mm	11 mm	9 mm	0,06 - 0,25 mm (AWG 42-30)	80 g	<p>High grade tool steel, anti-glare finish, ESD safe, high precision</p> <p>Front stripping tool. Unique high precision tool. Strips one size at a time without scratching the cores. For all kind of insulation, PTFE., Tefzel, fibre optics or stranded wires. Diameter adjustable with screw plus stop screw. Replaceable cutting blades. Supplied with screwdriver and hex key.</p>
									

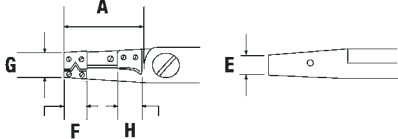
Side Stripping

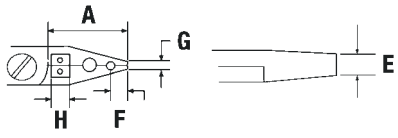
Model	L	A	E	F	G	H	Wire \varnothing	Weight	Description
 <p>552S</p>	120 mm	21 mm	6,5 mm	6,7 mm	11 mm	9 mm	0,06 - 0,25 mm (AWG 42-30)	80 g	<p>High grade tool steel, anti-glare finish, ESD safe, high precision</p> <p>Side stripping tool. Unique high precision tool. Strips one size at a time without scratching the cores. For all kind of insulation, PTFE., Tefzel, fibre optics or stranded wires. Diameter adjustable with screw plus stop screw. Replaceable cutting blades. Supplied with screwdriver and hex key.</p>
									
 <p>502E30</p>	120 mm	22 mm	3 mm	6,3 mm	2,4 mm	5 mm	0,25 mm (AWG 30)	67 g	<p>High grade tool steel, anti-glare finish, ESD safe</p> <p>Combination side stripping tool. Fine replaceable cutting blades. Strips resistant insulations such as PTFE., Tefzel, glass reinforced Fluoropolymere. This tool combines stripping, cutting and bending/gripping. For one specific wire diameter, AWG 30 (0,25 mm). Other diameters on request.</p>
									

Special Stripping

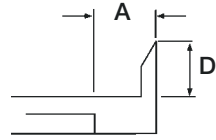
Model	L	A	D	Wire \varnothing	Weight	Description
 <p>520E</p>	120 mm	10 mm	11 mm	0,25 - 1,3 mm (AWG 30-16)	75 g	<p>High grade tool steel, anti-glare finish, ESD safe, high precision</p> <p>Strips one or several wires simultaneously. Particularly designed for mini or standard wire-wrapping work. Diameter adjustable with screw plus blocking nut.</p>
						



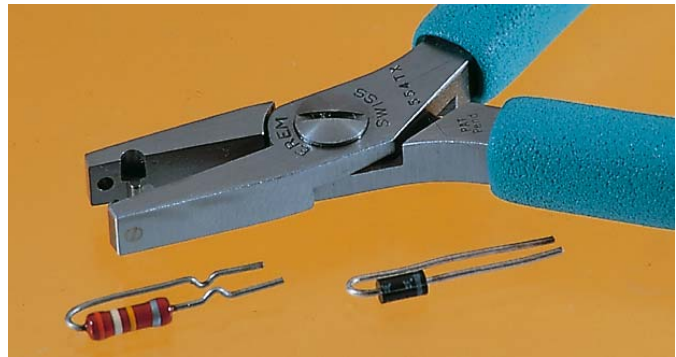

Pre-Forming Tools

Pre-Forming Tools



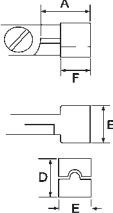
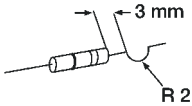

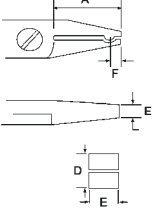
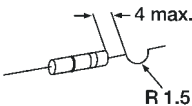
Erem offers preforming tools for active and passive components.

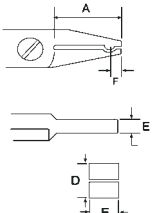
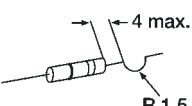

For Passive Components

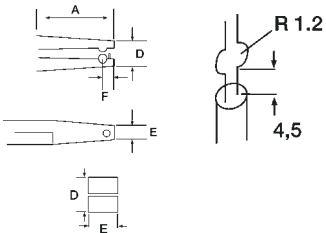
Model	L	A	D	E	F	Weight	Description
 <p>554E</p>	120 mm	13 mm	10 mm	10 mm	10 mm	70 g	<p>High grade tool steel, anti-glare finish, ESD safe</p> <p>Bending pliers for component leads, etc. U-shape.</p> <p>Max. lead \varnothing: Diodes: 0,65 mm Capacitors: 0,7 mm Resistors: 1/2 W</p>
							
 <p>554A</p>	120 mm	23 mm	5,6 mm	4 mm	4,5 mm	70 g	<p>High grade tool steel, anti-glare finish, ESD safe</p> <p>Bending pliers for component leads, etc. U-shape. Axial forming action.</p> <p>Max. lead \varnothing: Diodes: 0,65 mm Capacitors: 0,7 mm Resistors: 1/2 W</p>
							
 <p>554B</p>	120 mm	23 mm	5,6 mm	2,5 mm	4,5 mm	70 g	<p>High grade tool steel, anti-glare finish, ESD safe</p> <p>Bending pliers with tapered nose. For component leads, etc. U-shape. Axial forming action.</p> <p>Max. lead \varnothing: Diodes: 0,65 mm Capacitors: 0,7 mm Resistors: 1/2 W</p>
							

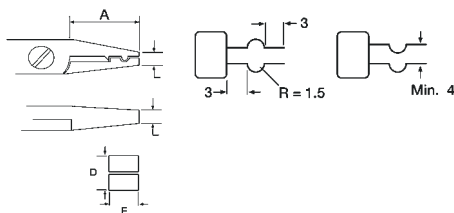
Pre-Forming Tools

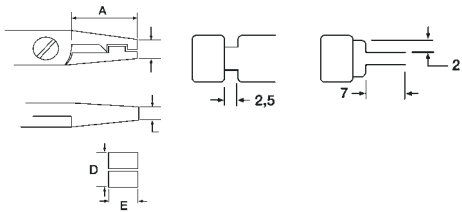



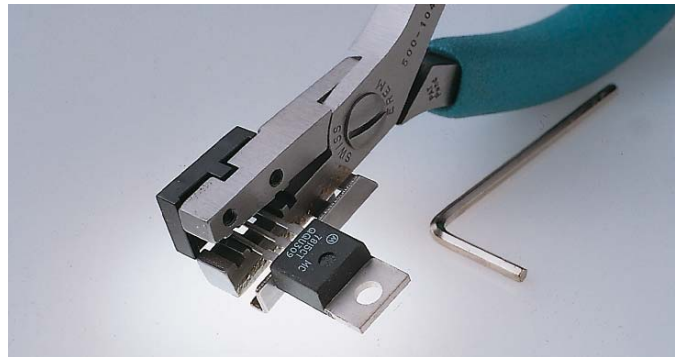
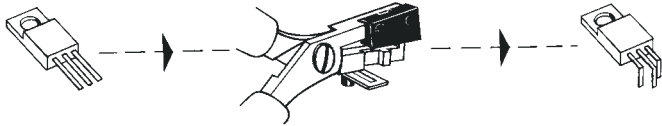

Model	L	A	D	E	F	Weight	Description
 <p>554TX</p>	120 mm	20 mm	6,5 mm	6,5 mm	4 mm	70 g	<p>High grade tool steel, anti-glare finish, ESD safe</p> <p>Bending pliers for forming stress reliefs. One lead left, one lead right in one single operation. For stable insertion.</p> <p>Max. lead ø: Diodes: 0,65 mm Capacitors: 0,7 mm Resistors: 1/2 W</p>
							
 <p>50788</p>	120 mm	23 mm	-	4 mm	3 mm	67 g	<p>High grade tool steel, anti-glare finish, ESD safe, cut + bend</p> <p>Bending pliers. Cuts and bends leads of popular radial components to a specific length.</p> <p>Max. lead ø: Diodes: 0,65 mm Capacitors: 0,7 mm Resistors: 1/2 W</p>
							
 <p>50789Z</p>	120 mm	23 mm	3,3 mm	3,5 mm	-	67 g	<p>High grade tool steel, anti-glare finish, ESD safe, cut + bend</p> <p>Bending pliers. Cuts and bends leads of various types of components.</p> <p>Max. lead ø: Diodes: 0,65 mm Capacitors: 0,7 mm Resistors: 1/2 W</p>
							

Pre-Forming Tools

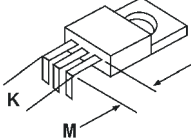
Pre-Forming Tools for Active Components

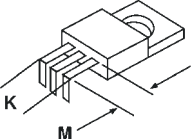

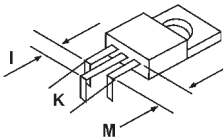

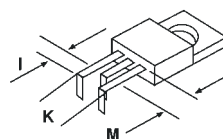
For Active Components

Model	L	K	M	I	Weight	Description
 500103A	120 mm	max. 15 mm	3-12 mm	-	85 g	High grade tool steel, anti-glare finish, ESD safe High precision preforming tool. Bends flat parts, contacts, power transistors, triac leads, etc. to a right angle. Adjustable with screw.
						
 500210E	120 mm	max. 11 mm	3,8-15 mm	-	85 g	High grade tool steel, anti-glare finish, ESD safe, cut + bend High precision preforming tool. Improved version of 500103A. Cuts and bends TO series, power transistor, LEDs, etc. simultaneously at 90° without stressing the component. Simple adjustment (M) and replaceable cutting blade.
						
 500104A	120 mm	max. 13 mm	3,5-15 mm	2,54 mm	85 g	3 leads, high grade tool steel, anti-glare finish, ESD safe High precision preforming tool for 3 leads. Bends TO 126, 218, 220, power transistor leads, etc. at 90° in two rows. Adjustable (M) with screw.
						
 500104AI	120 mm	max. 13 mm	3,5-15 mm	2,54 mm	85 g	3 leads, high grade tool steel, anti-glare finish, ESD safe, central lead backwards High precision preforming tool for 3 leads. Bends TO 126, 218, 220, power transistor leads, etc. at 90° in two rows. Adjustable (M) with screw. Central lead backwards.
						

Pre-Forming Tools

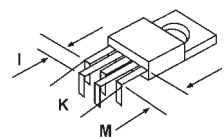
For Active Components

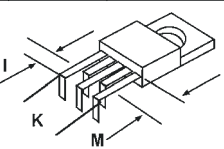
Model	L	K	M	I	Weight	Description
 500154A	120 mm	max. 13 mm	4,5-9,5 mm	2,54 mm	90 g	5 leads, high grade tool steel, anti-glare finish, ESD safe High precision preforming tool for 5 leads.. Bends TO 126, 218, 220, power transistor leads, etc. at 90° in two rows. Adjustable (M) with screw.
						
 500154AI	120 mm	max. 13 mm	4,5-9,5 mm	2,54 mm	90 g	5 leads, high grade tool steel, anti-glare finish, ESD safe, opposite leads backwards High precision preforming tool for 5 leads.. Bends TO 126, 218, 220, power transistor leads, etc. at 90° in two rows. Adjustable (M) with screw. Opposite leads backwards.
						

For Flat Packs, Quads

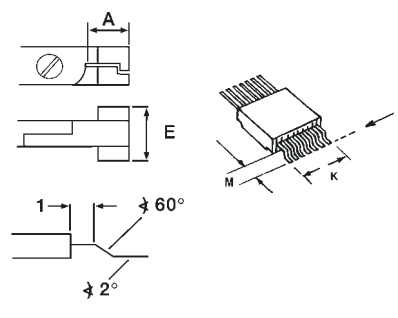
Model	L	A	K	M	Weight	Description
 80013C	120 mm	17 mm	max. 13 mm	2,8 mm	100 g	High grade tool steel, anti-glare finish, ESD safe High precision preforming tool. For flat packs, quads, etc. No friction effect. Designed after MIL specs. Cuts + bends.
						

For DIL / IC

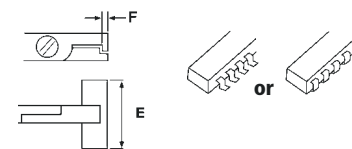
Model	L	E	F	Weight	Description
 809IC	120 mm	25 mm	0,9 mm	98 g	High grade tool steel, anti-glare finish, ESD safe High precision preforming tool. Cuts and bends DIL pins to a 90° angle in one operation. For up to 20 pin IC. Allows DIL-ICs to go SMT.
					

IC and SMD Tools

IC and SMD Tools

Erem IC and SMD tools for inserting, extracting, straightening and cutting of ICs and SMDs

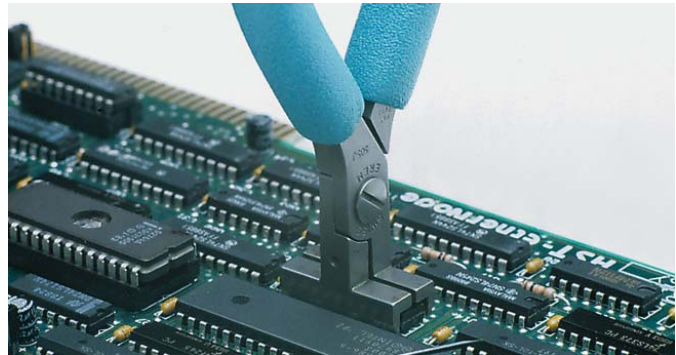



Inserting and Extracting

Model	L	Model	E	Weight	Description																		
505	120 mm	505C 505E 505A 505BGC 505BG	20 mm 27 mm 32 mm 36 mm 36 mm	-	<p>High grade tool steel, anti-glare finish, ESD safe</p> <p>Inserting and extracting pliers. Available sizes see chart. Adjustable with screw. Insertion: squeeze IC pins. Extraction: adjust jaws width so that pins stay in the middle of holes.</p>																		
<table border="0"> <tr> <td></td> <td>505C</td> <td>505E</td> <td>505A</td> <td>505BGC</td> <td>505BG</td> </tr> <tr> <td>Pins:</td> <td>14-16</td> <td>22</td> <td>24</td> <td>28</td> <td>28</td> </tr> <tr> <td>Width:</td> <td>.300</td> <td>.400</td> <td>.600</td> <td>.300</td> <td>.600</td> </tr> </table>							505C	505E	505A	505BGC	505BG	Pins:	14-16	22	24	28	28	Width:	.300	.400	.600	.300	.600
	505C	505E	505A	505BGC	505BG																		
Pins:	14-16	22	24	28	28																		
Width:	.300	.400	.600	.300	.600																		

Straightening

Model	L	A	E	G	Weight	Description
 508Z	125 mm	23 mm	20 mm	1 mm	85 g	<p>8 pins, high grade tool steel, anti-glare finish, ESD safe</p> <p>Straightening pliers. For multiple DIL / IC leads. Before insertion or after soldering. Laterally (a) or parallel (b). For up to 8 pins. Ideal maintenance tool.</p>
 808G	130 mm	23 mm	42 mm	1 mm	120 g	<p>16 pins, high grade tool steel, anti-glare finish, ESD safe</p> <p>Straightening pliers. For multiple DIL / IC leads. Before insertion or after soldering. Laterally (a) or parallel (b). For up to 16 pins. Ideal maintenance tool.</p>

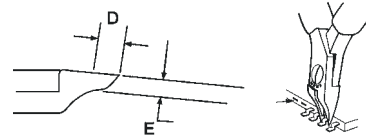
Cutting

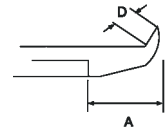
Model	L	A	D	E	Weight	Description
 670EP	110 mm	10 mm	3 mm	2 mm	48 g	<p>Flush, high grade tool steel, anti-glare finish, ESD safe, resharpenable</p> <p>High precision tip cutter. For cutting leads of SMD micro packages up to 0,25 mm or fine pitch components less than 1/20". Cuts pins before heat desoldering. Essential SMD tool. No breakage guarantee. For μ-pitches below 0,5 mm model 670EPF is necessary. Please supply IC together with order.</p>
						
 593AE	115 mm	20 mm	4 mm	-	67 g	<p>Flush, high grade tool steel, anti-glare finish, ESD safe, resharpenable</p> <p>High precision tip cutter bent. For cutting DIL leads from the rear. Ideal maintenance tool. Cuts pins before heat desoldering.</p>
						

Trimming

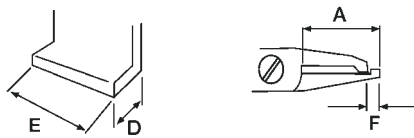
Model	L	A	D	E	F	Weight	Description
 509E	120 mm	21 mm	3,5 mm	21,5 mm	1,5 mm	74 g	<p>8 pins, high grade tool steel, anti-glare finish, ESD safe, trim</p> <p>Trimming pliers. Trims an entire row of 8 pins to the same length. The lead tips are cut flat. For multiple DIL / IC leads. Before insertion or after soldering.</p>
							

Fibre Optic Tools

Fibre Optic Tools

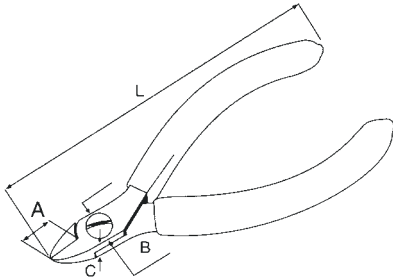
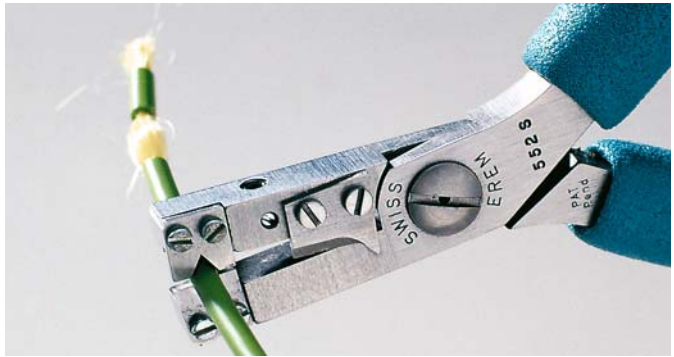

High precision tools for working on fibre optics.

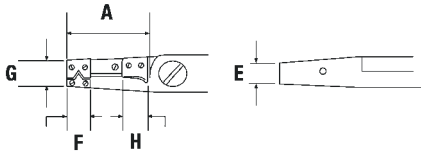

Side Stripping

Model	L	A	E	F	G	H	Wire ø	Weight	Description
 552S	120 mm	21 mm	6,5 mm	6,7 mm	11 mm	9 mm	0,06 - 0,25 mm AWG 42 - 30	80 g	<p>High grade tool steel, anti-glare finish, ESD safe, high precision</p> <p>Side stripping tool. Unique high precision tool. Strips one size at a time without scratching the cores. For all kind of insulation, PTFE, Tefzel, fibre optics or stranded wires. Diameter adjustable with screw plus screw stop. With replaceable cutting blade. Supplied with screwdriver and hex key. Fixed standard ø like 125 µ on request.</p>
									

Cutting

Model	L	A	B	C	Weight	Description
 599FO	115 mm	11,5 mm	10,5 mm	6,5 mm	67 g	<p>A unique high precision cutter for Kevlar® silks</p> <p>Cuts all silks even very close to fibre core. Avoid any other application.</p>
 599TFO	115 mm	15 mm	10,5 mm	6,5 mm	67 g	<p>Semi flush cut, Tungsten Carbide blades, anti-glare finish, ESD safe</p> <p>Side cutter with Tungsten Carbide blades. For cutting Vectran braided wires, fibre optics, Kevlar and small stainless steel braids. Ask for special application.</p>

Holding / Gripping

Model	L	Weight	Description
 249SA	130 mm	20 g	<p>Special stainless steel / PPS, anti-glare finish, non-magnetic, ESD safe, suitable for fibre optics</p> <p>Precision tweezers with serrated grips and synthetic tips (PPS). Heat resistant up to 250°C (480°F). Resistant to acids and solder. Waterproof, ESD safe. Does not damage fibre optic cores.</p>

Kits

Erem kits offer a range of popular tweezers, cutters and pliers in different combinations.



Kit for SMD Handling

	L	Width	Thickness	Weight	Description
3900KC	130 mm	230 mm	30 mm	350 g	<p>Black plastic case, cushioned, ESD safe, consists of:</p> <p>Tweezers 51SA Precision tweezers 115 mm, bent 30°, relieved. Very fine tips. Stainless steel, anti-glare finish, non-magnetic. 102ACA SMD tweezers 115 mm, with angled head and blunted edges to avoid board damaging. For handling of small components. Special stainless steel, anti-glare finish, non-magnetic. 103ACA SMD tweezers 115 mm, with angled head 45° and blunted edges to avoid board damaging. For horizontal handling of small components. Special stainless steel, anti-glare finish, non-magnetic. 150SAMB SMD tweezers 120 mm, bent 40°, serrated handles. For gripping small cylindrical parts \varnothing 1,2 - 2,5 mm, special stainless steel, anti-glare finish, non-magnetic. 150SAMF SMD tweezers 120 mm, straight, serrated handles. For gripping small cylindrical parts \varnothing 1,2 - 2,5 mm, special stainless steel, anti-glare finish, non-magnetic.</p> <p>Cutters 670EP High precision tip cutter 110 mm. For cutting leads of SMD micro packages up to 0,25 mm or fine pitch components less than 1/20". Flush cut, high grade tool steel, anti-glare finish, ESD safe.</p>



Vacuum Manipulator

Vacuum Manipulator

The Erem 3000 series offers a vacuum micro manipulation system for precise handling of tiny components as well as flat parts. For use in mechanical assembly, laboratories, etc. The advantages are:

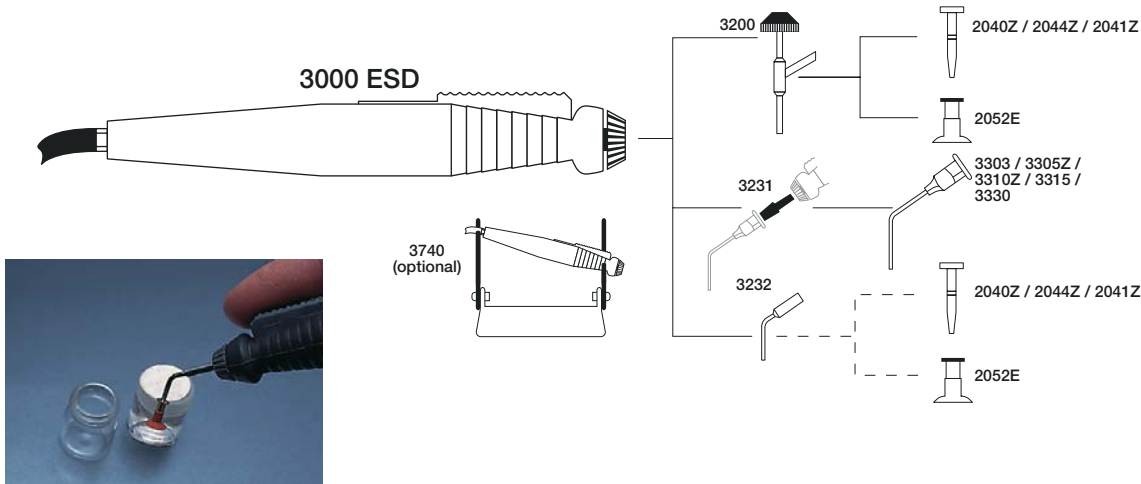
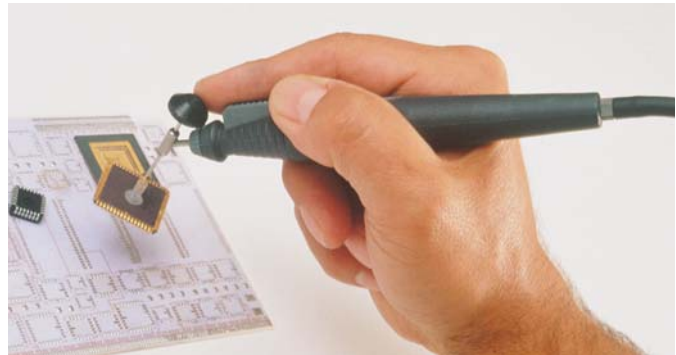

- easy pick up of components or silicon wafers
- immediate pick up and release of the parts
- full 360° rotating system
- direct axial air switch
- ergonomic shape reduces hand and wrist fatigue
- ESD safe



Housing

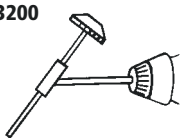
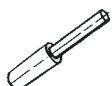

Model	L	Diameter	Weight	Description
3000ESD	140 mm	10 mm	35 g	Housing Housing with axial air switch, ergonomic shape, serrated grip area, ESD safe. Professional device.

Inserts for Housing 3000ESD Adapter

Model	L	Weight	Description
3200 	25 mm	15 g	Adapter 360° rotating head for housing 3000ESD. With straight nozzle, stainless steel for direct pick-up or as adapter for suction tips or suction cups.
3231 	5 mm	5 g	Adapter Adapter fix. For use with suction tips series 3300.
3232 	15 mm total	3 g	Adapter Can be used with or without tips, fix. Holds either suction cup 2052E or tips 2040Z, 2041Z, 2044Z.

Vacuum Manipulator

Suction Tips Straight

Model	Outside \varnothing	Inside \varnothing	Description
2040Z 	0,70 mm	0,15 mm	Suction tip straight, PTFE, tip For use with rotating head 3200 or fix adapter 3232.
2044Z 	1,30 mm	0,90 mm	Suction tip straight, Polyethylene tip For use with rotating head 3200 or fix adapter 3232.
2041Z 	2,0 mm	1,40 mm	Suction tip straight, Polyethylene tip For use with rotating head 3200 or fix adapter 3232.

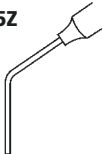
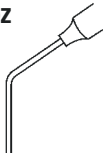
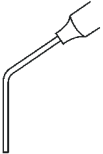
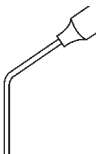

Suction Needles

Model	Outside \varnothing	Inside \varnothing	Description
3303 	0,30 mm	0,16 mm	Suction needle bent 45°, stainless steel For use with fix adapter 3231.
3305Z 	0,50 mm	0,25 mm	Suction needle bent 45°, stainless steel For use with fix adapter 3231.
3310Z 	1,0 mm	0,65 mm	Suction needle bent 45°, stainless steel For use with fix adapter 3231.
3315 	1,5 mm	1,0 mm	Suction needle bent 45°, stainless steel For use with fix adapter 3231.
3330 	3,0 mm	2,5 mm	Suction needle bent 45°, stainless steel For use with fix adapter 3231.

Suction Cups

Model	Diameter \varnothing	Description
2052E 	4,5 mm	Suction cup, Silicone rubber For use with rotating head 3200 or fix adapter 3232.

Wafer Handling

Wafer Handling

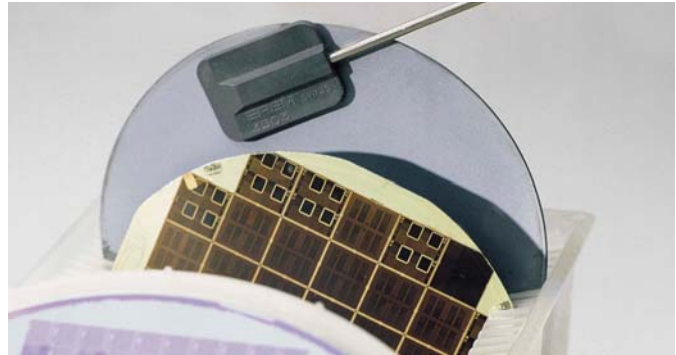
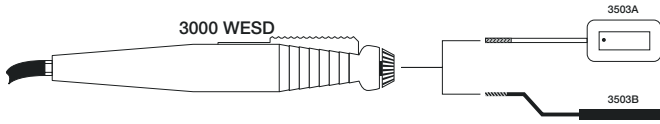

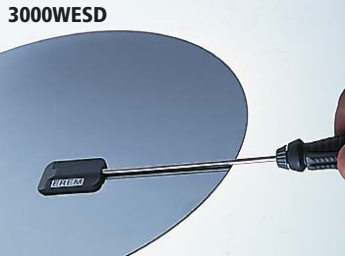
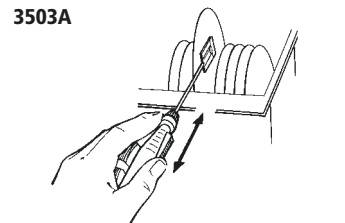
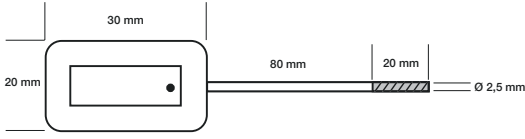
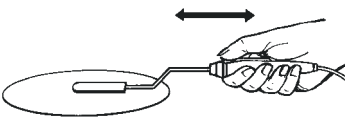
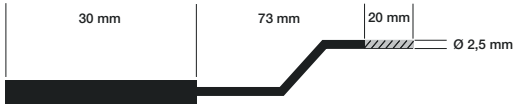
Model	Size	Description
3000WESD 	140 mm (length)	Pick-up device Pick-up device for silicon wafers up to 8". ESD-safe. Needs min. -600 mBar vacuum. For use with suction plates 3503A or 3503B.
3503A 		Insert for vertical pick-up for silicon wafers up to 8" For vertical pick up. Armite suction plate with stainless steel tube, ESD safe.
3503B 		Insert for horizontal pick-up for silicon wafers up to 8" Stainless steel tubing bent for horizontal pick up. Angles can be determined by customer, no price surcharge. Armite suction plate with stainless steel tube, ESD safe.

Accessories

Model	Description
3714Z	<p>Pump</p> <p>Membrane pump 230V, silent running, air volume 5 l/min, max. vacuum -250 mbar. (not suitable for wafer pick up)</p>
3008ESD	<p>Tubing System</p> <p>Tubing system flexible, 1,8 m, ESD safe.</p>
3717	<p>Filter</p> <p>Filter for tubing system 3008ESD.</p>
3740	<p>Table Holder</p> <p>Table holder for 3000ESD and 3000WESD housing (without accessory).</p>



Vacuum Kit

Model	Size	Weight	Description
3000KCESD	400 x 320 x 105 mm	2,2 kg	<p>Black plastic case, cushioned, consists of:</p> <ul style="list-style-type: none"> 3000ESD Housing 3200 Head / adapter rotating 3231 Adapter fixed 3305Z, 3310Z, 3315 Suction needles bent 2052E suction cup ø 4,5 mm KDS 260L suction cup ø 9,5 mm 3740 Table holder for 3000ESD 3714Z Membran pump 230 V 3008ESD Tubing system 1,8 m 3717 Air filter 102ACA SMD tweezers 115 mm





Index Tweezers

Model	Page	Model	Page	Model	Page
024C	.16	51SA	.9	O0BSA	.6
028	.16	51SASL	.9	O0CSA	.6
1SA	.6	52ASA	.11	O0DSA	.6
1SASL	.6	53CSA	.5	O0SA	.6
2ASA	.10	64SA	.6	O0SASL	.6
2ASARU	.11	65ASA	.10	RRS	.7
2ASASL	.11	91SA	.14	SSSA	.7
2ASASLT	.11	102ACA	.12	SSSASL	.7
2SA	.8	102ACAX	.12		
2SASL	.8	103ACA	.12		
3CBS	.9	140SA	.14		
3CS	.5	141SAP	.14		
3CSA	.5	141SAPH	.14		
3CSASL	.5	150SA	.13		
3CTA	.5	150SAD	.12		
3SA	.6	150SAMB	.13		
3SASL	.6	150SAMF	.12		
4SA	.8	151SA	.13		
4SASL	.8	249SA	.7, 50		
5ASA	.9	249CER	.7		
5ASASL	.9	258SA	.9		
5BSA	.9	500ASA	.14		
5CSA	.9	600ASA	.14		
5FSA	.8	600JSA	.14		
5MBS	.8	608ASA	.14		
5SA	.8	940AS	.13		
5SASL	.8	AAS	.6		
7SA	.10	AASA	.7		
7SASL	.10	AASASL	.7		
11N	.6	AASSL	.7		
15AGS	.15	AAZ	.6		
15AGW	.15	ACSA	.5		
20AS	.5	AM	.7		
21SA	.7	E2ASA	.11		
24SA	.10	E3CSA	.11		
25SA	.11	E5SA	.11		
29SA	.7	E7SA	.11		
29W30	.15	E0OSA	.11		
29Y	.15	M4AS	.8		
30SA	.10	M5S	.5		
32BSA	.13				
32BSA20	.13				
32BSA25	.12				
39SA	.12				
40SA	.12				

Suffix
None carbone steel
E (Prefix) ergonomic handles
M Brass, soft material to avoid damage, no sparks
N Nickel-Silver alloy, absolut nicht
PYR Pyroplast coating
RU anti adhesive coating
S stainless steel
SA, CA special stainless steel, non-magnetic, acid resistant
SL economy version
TA Titanium, non-magnetic, lightweight, high temperature resistant
Z Nickel plated

Index Cutters and Pliers

Model	Page	Model	Page	Model	Page
147A	.27	599TF	.23	3305Z	.53
500108	.36	599TFO	.23, 50	3310Z	.53
500103A	.46			3315	.53
500104A	.46	611E	.22	3330	.53
500104AI	.46	612E	.22	3503A	.54
500154A	.47	612N	.22	3503B	.54
500154AI	.47	622N	.22	3714Z	.55
500210E	.46	622NA	.24	3717	.55
502E30	.43	622NB	.25	3740	.55
503ET	.30	632N	.22	3900KC	.51
503ET	.30	632NCF	.26		
503ETF	.30	670E	.32	EROP155	.40
504AE	.30	670EP	.32, 49	EROP170	.42
505A/BG/BGC/C/E	.48	670EPF	.32, 49	EROP171	.42
50788	.45	676E	.26	EROP172	.41
50789Z	.45	677E	.24	EROP174	.41
508Z	.48			EROP277	.41
509E	.49	710E	.22	EROP280	.41
510AE	.42	776E	.26	EROP330	.41
511E	.23	792E	.26	EROP331	.40
512E	.23			EROP355	.40
512N	.22	80013C	.47	EROP357	.40
520E	.43	808G	.48	EROP419	.40
521E	.23	809IC	.47		
522E	.23	812N	.24		
522N	.23	822N	.24		
530E	.36	884E	.26		
530E15A	.36	884EPCM	.27		
530S	.36	886E	.25		
531E	.37	896E	.24		
532N	.23				
542E	.37	1500BSF	.34		
543E	.37	1503N	.35		
544D	.38	1512N	.34		
544E	.38	1522N	.34		
546E	.38	1522NA	.35		
547	.37	1522NB	.35		
549E	.36				
552E	.43	2040Z	.53		
552S	.43, 50	2041Z	.53		
554A	.44	2044Z	.53		
554B	.44	2052E	.53		
554E	.44	2211P	.39		
554TX	.45	2212E	.27		
555E	.31	2222E	.27		
570E	.32	2222EA	.28		
572E	.31	2222EB	.28		
573E	.33	2232E	.27		
573EB	.36	2242E	.39		
575E	.30	2282E	.33		
576TX	.26				
576Z	.26	3000ESD	.52		
577E	.25	3000KCESD	.55		
582E	.31	3000WESD	.54		
582EW	.31	3008ESD	.55		
592E	.26	3200	.52		
593AE	.31, 49	3231	.52		
595E	.25	3232	.52		
595T	.24	3303	.53		
595TF	.25				
597E	.23				
599E	.23				
599FO	.50				
599T	.23				



COOPER Hand Tools

Campbell® Caulk Master® Crescent® Diamond® Erem® Kahmetics® Lufkin®
Nicholson® Plumb® H.K.Porter® Weller® Wire-Wrap® Wiss® Xcelite®

© 2004, Cooper Industries, Inc.
Specifications subject to change without notice.

GERMANY
Cooper Tools GmbH
Carl-Benz-Str. 2
74354 Besigheim
Tel: (07143) 580-0
Fax: (07143) 580-108

FRANCE
Cooper Tools S.A.
25 Rue Maurice Chevalier BP 46
77832 Ozoir-la-Ferrière Cedex
Tel: (01) 60.18.55.40
Fax: (01) 64.40.33.05

GREAT BRITAIN
Cooper Tools Ltd.
Suite 15, Coniston House
Town Centre
Washington, Tyne & Wear
NE38 7RN
Tel: (0191) 419 7700
Fax: (0191) 417 9421

ITALY
Cooper Italia S.p.A.
Viale Europa 80
20090 Cusago (MI)
Tel: (02) 9033101
Fax: (02) 90394231

SWITZERLAND
Erem S.A.
Rue de la Roselière 8
1400 Yverdon les Bains
Tel: (024) 426 12 06
Fax: (024) 425 09 77