

PDTC114E series

NPN resistor-equipped transistors;
R1 = 10 k Ω , R2 = 10 k Ω

Rev. 12 — 21 December 2011

Product data sheet

1. Product profile

1.1 General description

NPN Resistor-Equipped Transistor (RET) family in small Surface-Mounted Device (SMD) plastic packages.

Table 1. Product overview

| Type number | Package | | | PNP complement | Package configuration |
|-------------|---------|--------|----------|----------------|-----------------------|
| | NXP | JEITA | JEDEC | | |
| PDTC114EE | SOT416 | SC-75 | - | PDTA114EE | ultra small |
| PDTC114EM | SOT883 | SC-101 | - | PDTA114EM | leadless ultra small |
| PDTC114ET | SOT23 | - | TO-236AB | PDTA114ET | small |
| PDTC114EU | SOT323 | SC-70 | - | PDTA114EU | very small |

1.2 Features and benefits

- 100 mA output current capability
- Built-in bias resistors
- Simplifies circuit design
- Reduces component count
- Reduces pick and place costs
- AEC-Q101 qualified

1.3 Applications

- Digital application in automotive and industrial segments
- Control of IC inputs
- Cost-saving alternative for BC847/857 series in digital applications
- Switching loads

1.4 Quick reference data

Table 2. Quick reference data

| Symbol | Parameter | Conditions | Min | Typ | Max | Unit |
|------------------|---------------------------|------------|-----|-----|-----|------------|
| V _{CEO} | collector-emitter voltage | open base | - | - | 50 | V |
| I _O | output current | | - | - | 100 | mA |
| R1 | bias resistor 1 (input) | | 7 | 10 | 13 | k Ω |
| R2/R1 | bias resistor ratio | | 0.8 | 1.0 | 1.2 | |



2. Pinning information

Table 3. Pinning

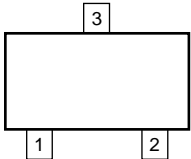
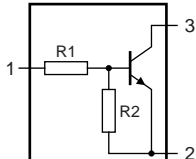
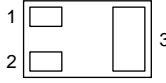
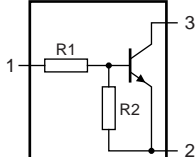
| Pin | Description | Simplified outline | Graphic symbol |
|------------------------------|--------------------|---|---|
| SOT23; SOT323; SOT416 | | | |
| 1 | input (base) |  <p>006aaa144</p> |  <p>sym007</p> |
| 2 | GND (emitter) | | |
| 3 | output (collector) | | |
| SOT883 | | | |
| 1 | input (base) |  <p>Transparent top view</p> |  <p>sym007</p> |
| 2 | GND (emitter) | | |
| 3 | output (collector) | | |

3. Ordering information

Table 4. Ordering information

| Type number | Package | | |
|-------------|---------|---|---------|
| | Name | Description | Version |
| PDTC114EE | SC-75 | plastic surface-mounted package; 3 leads | SOT416 |
| PDTC114EM | SC-101 | leadless ultra small plastic package; 3 solder lands; body 1.0 × 0.6 × 0.5 mm | SOT883 |
| PDTC114ET | - | plastic surface-mounted package; 3 leads | SOT23 |
| PDTC114EU | SC-70 | plastic surface-mounted package; 3 leads | SOT323 |

4. Marking

Table 5. Marking codes

| Type number | Marking code ^[1] |
|-------------|-----------------------------|
| PDTC114EE | 09 |
| PDTC114EM | DS |
| PDTC114ET | *16 |
| PDTC114EU | *09 |

[1] * = placeholder for manufacturing site code.

5. Limiting values

Table 6. Limiting values

In accordance with the Absolute Maximum Rating System (IEC 60134).

| Symbol | Parameter | Conditions | Min | Max | Unit | |
|------------------|---------------------------|-------------------------------------|--------|------|------|----|
| V _{CBO} | collector-base voltage | open emitter | - | 50 | V | |
| V _{CEO} | collector-emitter voltage | open base | - | 50 | V | |
| V _{EBO} | emitter-base voltage | open collector | - | 10 | V | |
| V _I | input voltage | | | | | |
| | positive | | - | +40 | V | |
| | negative | | - | -10 | V | |
| I _O | output current | | - | 100 | mA | |
| I _{CM} | peak collector current | single pulse; t _p ≤ 1 ms | - | 100 | mA | |
| P _{tot} | total power dissipation | T _{amb} ≤ 25 °C | | | | |
| | PDTC114EE (SOT416) | | [1][2] | - | 150 | mW |
| | PDTC114EM (SOT883) | | [2][3] | - | 250 | mW |
| | PDTC114ET (SOT23) | | [1] | - | 250 | mW |
| | PDTC114EU (SOT323) | | [1] | - | 200 | mW |
| T _j | junction temperature | | - | 150 | °C | |
| T _{amb} | ambient temperature | | -65 | +150 | °C | |
| T _{stg} | storage temperature | | -65 | +150 | °C | |

[1] Device mounted on an FR4 Printed-Circuit Board (PCB), single-sided copper, tin-plated and standard footprint.

[2] Reflow soldering is the only recommended soldering method.

[3] Device mounted on an FR4 PCB with 70 μm copper strip line, standard footprint.

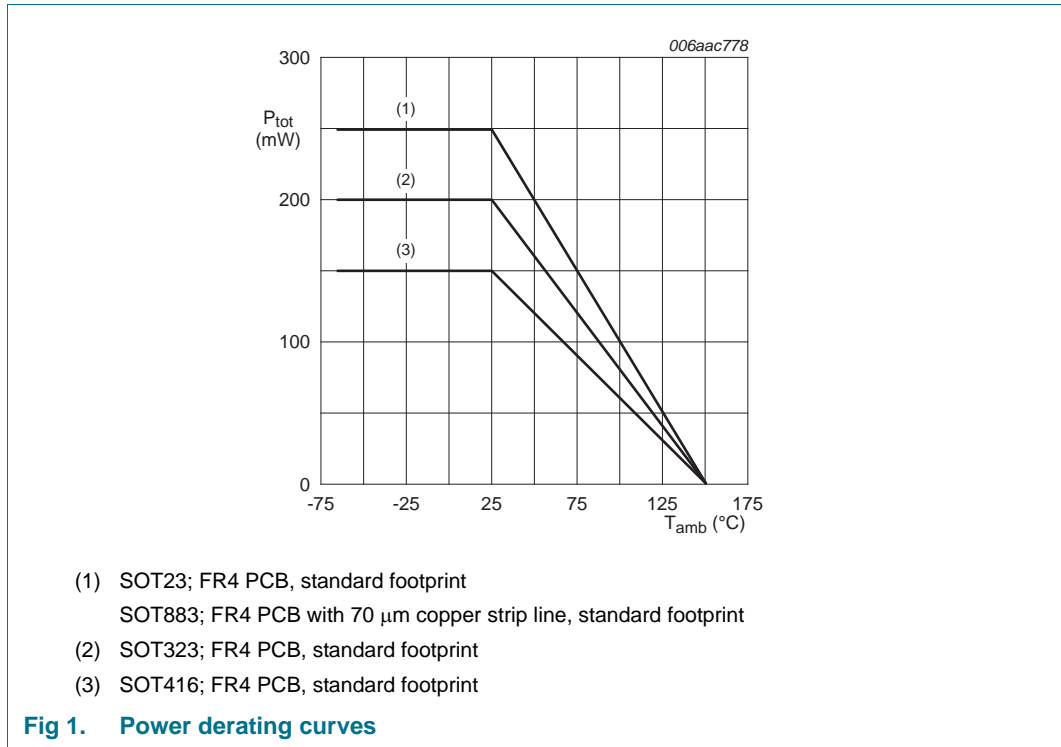

6. Thermal characteristics

Table 7. Thermal characteristics

| Symbol | Parameter | Conditions | Min | Typ | Max | Unit |
|----------------------|---|-------------|-----|-----|-----|------|
| R _{th(j-a)} | thermal resistance from junction to ambient | in free air | | | | |
| | PDTC114EE (SOT416) | [1][2] | - | - | 830 | K/W |
| | PDTC114EM (SOT883) | [2][3] | - | - | 500 | K/W |
| | PDTC114ET (SOT23) | [1] | - | - | 500 | K/W |
| | PDTC114EU (SOT323) | [1] | - | - | 625 | K/W |

[1] Device mounted on an FR4 PCB, single-sided copper, tin-plated and standard footprint.

[2] Reflow soldering is the only recommended soldering method.

[3] Device mounted on an FR4 PCB with 70 μm copper strip line, standard footprint.

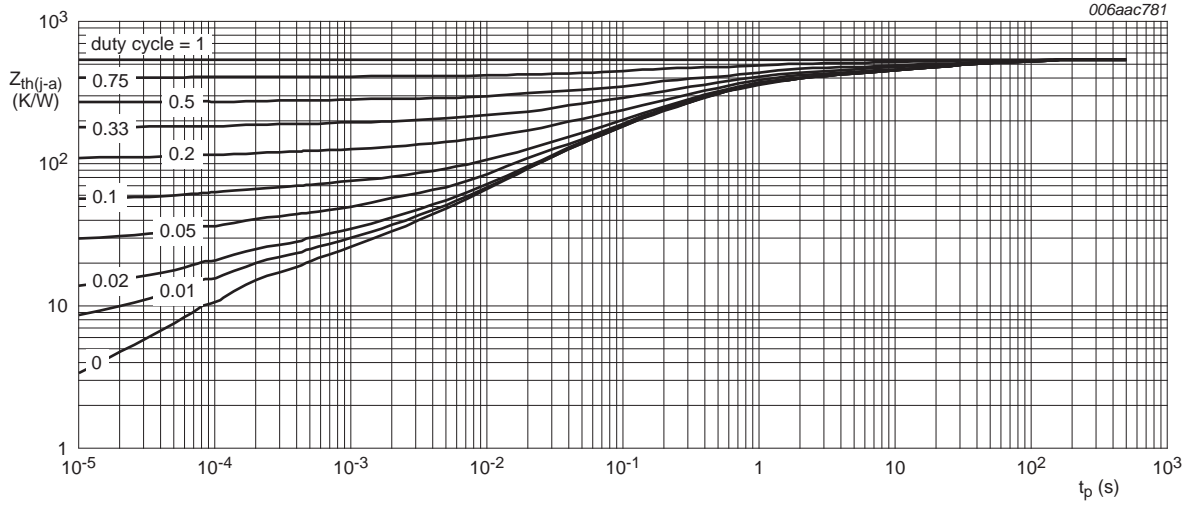

FR4 PCB, standard footprint

Fig 2. Transient thermal impedance from junction to ambient as a function of pulse duration for PDTC114EE (SOT416); typical values

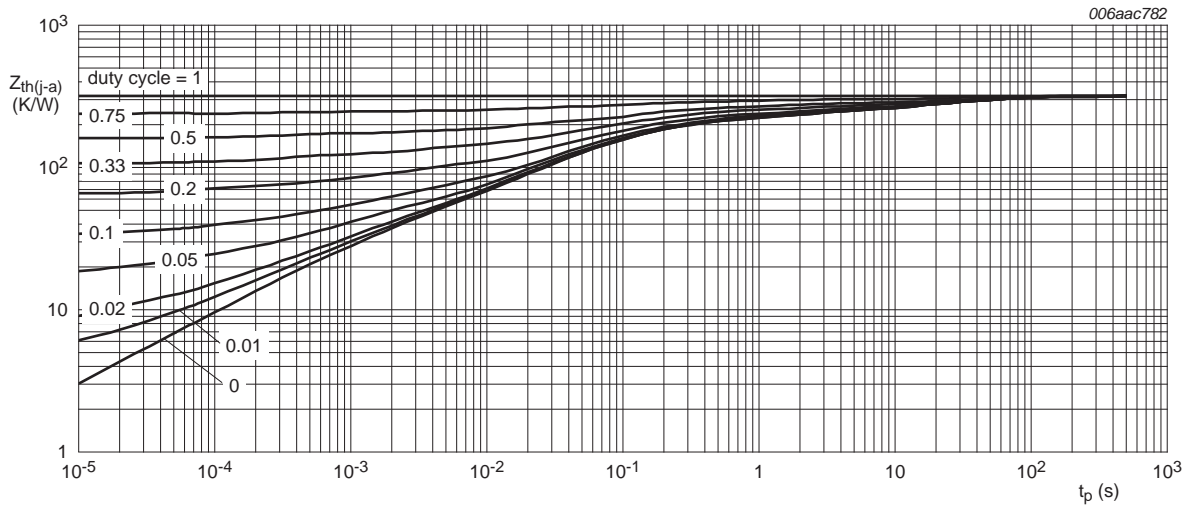

FR4 PCB, 70 μm copper strip line

Fig 3. Transient thermal impedance from junction to ambient as a function of pulse duration for PDTC114EM (SOT883); typical values

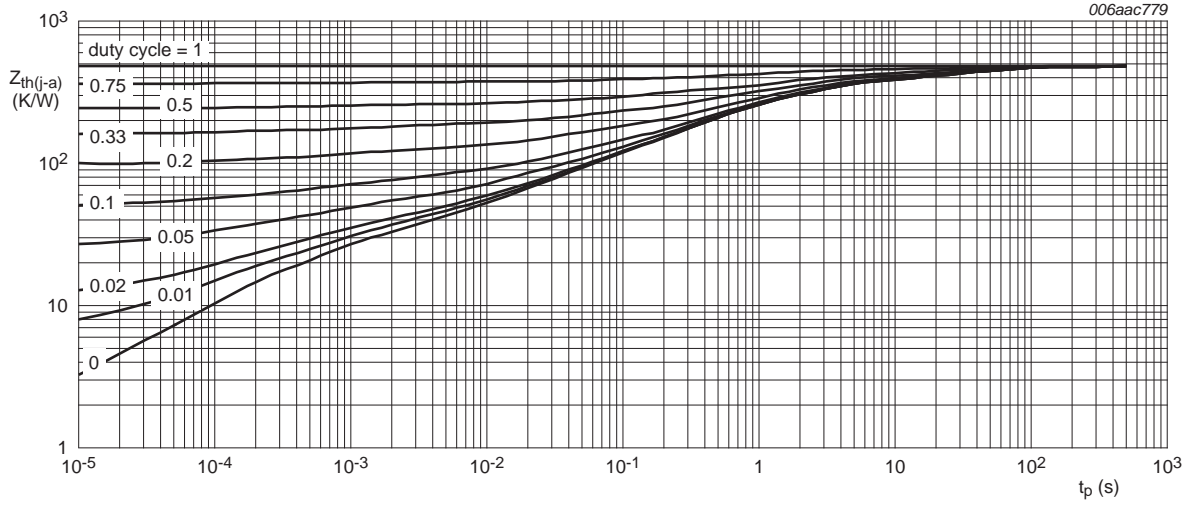

FR4 PCB, standard footprint

Fig 4. Transient thermal impedance from junction to ambient as a function of pulse duration for PDTC114ET (SOT23); typical values

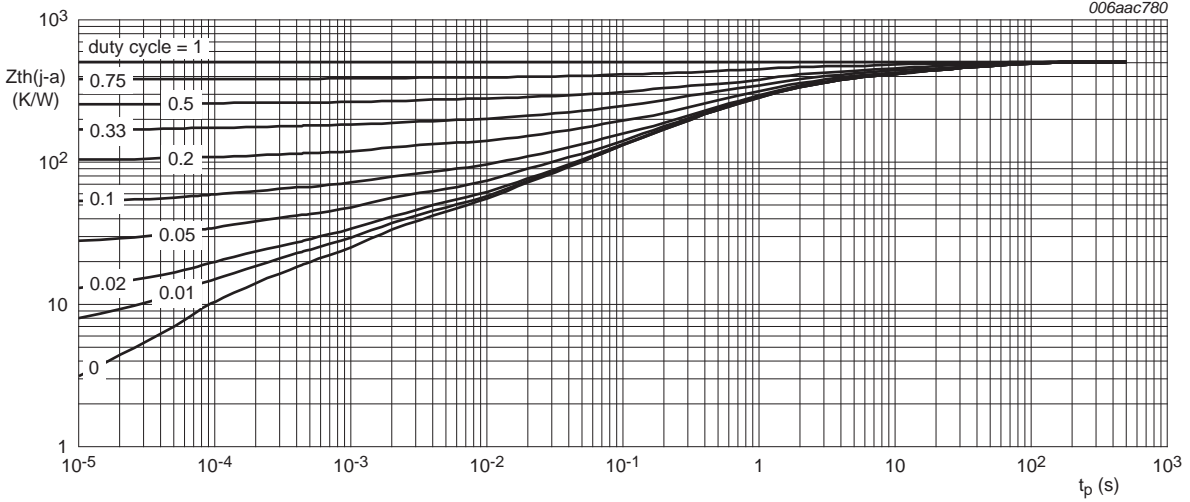

FR4 PCB, standard footprint

Fig 5. Transient thermal impedance from junction to ambient as a function of pulse duration for PDTC114EU (SOT323); typical values

7. Characteristics

Table 8. Characteristics

$T_{amb} = 25\text{ °C}$ unless otherwise specified.

| Symbol | Parameter | Conditions | Min | Typ | Max | Unit | |
|--------------|--------------------------------------|--|-----|-----|-----|------|-----|
| I_{CBO} | collector-base cut-off current | $V_{CB} = 50\text{ V}; I_E = 0\text{ A}$ | - | - | 100 | nA | |
| I_{CEO} | collector-emitter cut-off current | $V_{CE} = 30\text{ V}; I_B = 0\text{ A}$ | - | - | 1 | μA | |
| | | $V_{CE} = 30\text{ V}; I_B = 0\text{ A}; T_j = 150\text{ °C}$ | - | - | 5 | μA | |
| I_{EBO} | emitter-base cut-off current | $V_{EB} = 5\text{ V}; I_C = 0\text{ A}$ | - | - | 400 | μA | |
| h_{FE} | DC current gain | $V_{CE} = 5\text{ V}; I_C = 5\text{ mA}$ | 30 | - | - | | |
| V_{CEsat} | collector-emitter saturation voltage | $I_C = 10\text{ mA}; I_B = 0.5\text{ mA}$ | - | - | 150 | mV | |
| $V_{I(off)}$ | off-state input voltage | $V_{CE} = 5\text{ V}; I_C = 100\text{ μA}$ | - | 1.1 | 0.8 | V | |
| $V_{I(on)}$ | on-state input voltage | $V_{CE} = 0.3\text{ V}; I_C = 10\text{ mA}$ | 2.5 | 1.8 | - | V | |
| R1 | bias resistor 1 (input) | | 7 | 10 | 13 | kΩ | |
| R2/R1 | bias resistor ratio | | 0.8 | 1.0 | 1.2 | | |
| C_c | collector capacitance | $V_{CB} = 10\text{ V}; I_E = I_C = 0\text{ A}; f = 1\text{ MHz}$ | - | - | 2.5 | pF | |
| f_T | transition frequency | $V_{CE} = 5\text{ V}; I_C = 10\text{ mA}; f = 100\text{ MHz}$ | [1] | - | 230 | - | MHz |

[1] Characteristics of built-in transistor.

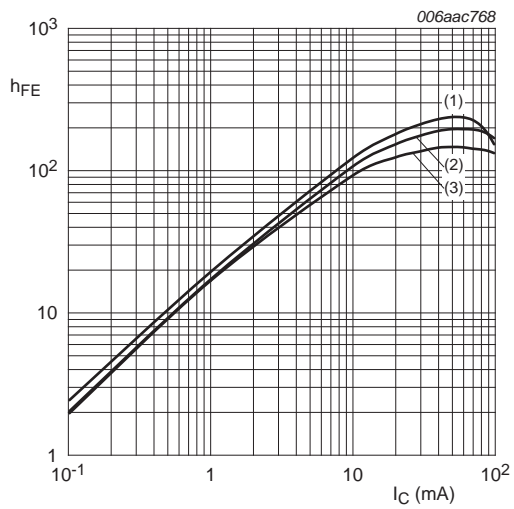

$V_{CE} = 5\text{ V}$
 (1) $T_{amb} = 100\text{ }^{\circ}\text{C}$
 (2) $T_{amb} = 25\text{ }^{\circ}\text{C}$
 (3) $T_{amb} = -40\text{ }^{\circ}\text{C}$

Fig 6. DC current gain as a function of collector current; typical values

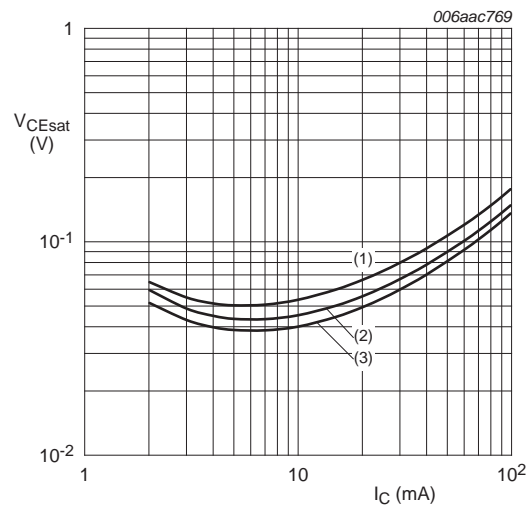

$I_C/I_B = 20$
 (1) $T_{amb} = 100\text{ }^{\circ}\text{C}$
 (2) $T_{amb} = 25\text{ }^{\circ}\text{C}$
 (3) $T_{amb} = -40\text{ }^{\circ}\text{C}$

Fig 7. Collector-emitter saturation voltage as a function of collector current; typical values

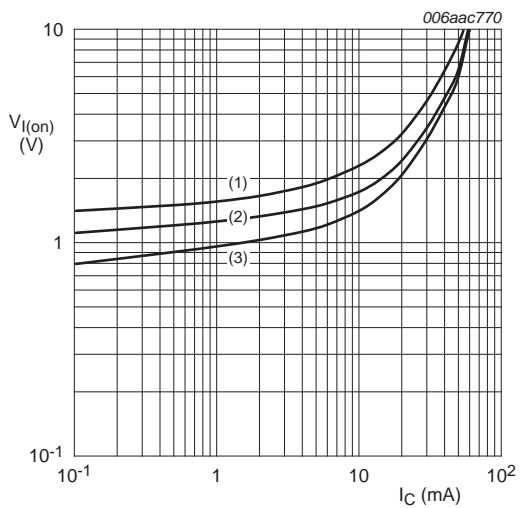

$V_{CE} = 0.3\text{ V}$
 (1) $T_{amb} = -40\text{ }^{\circ}\text{C}$
 (2) $T_{amb} = 25\text{ }^{\circ}\text{C}$
 (3) $T_{amb} = 100\text{ }^{\circ}\text{C}$

Fig 8. On-state input voltage as a function of collector current; typical values

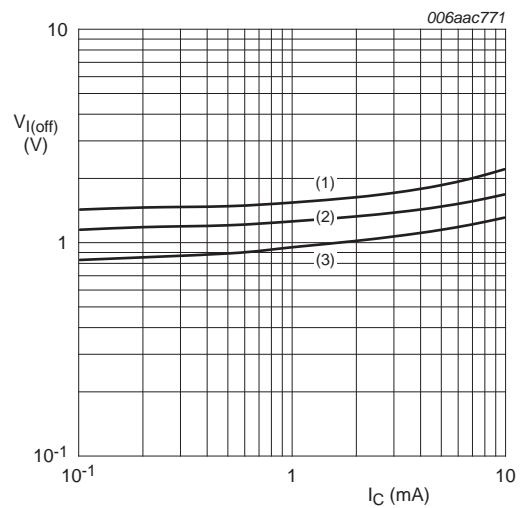

$V_{CE} = 5\text{ V}$
 (1) $T_{amb} = -40\text{ }^{\circ}\text{C}$
 (2) $T_{amb} = 25\text{ }^{\circ}\text{C}$
 (3) $T_{amb} = 100\text{ }^{\circ}\text{C}$

Fig 9. Off-state input voltage as a function of collector current; typical values

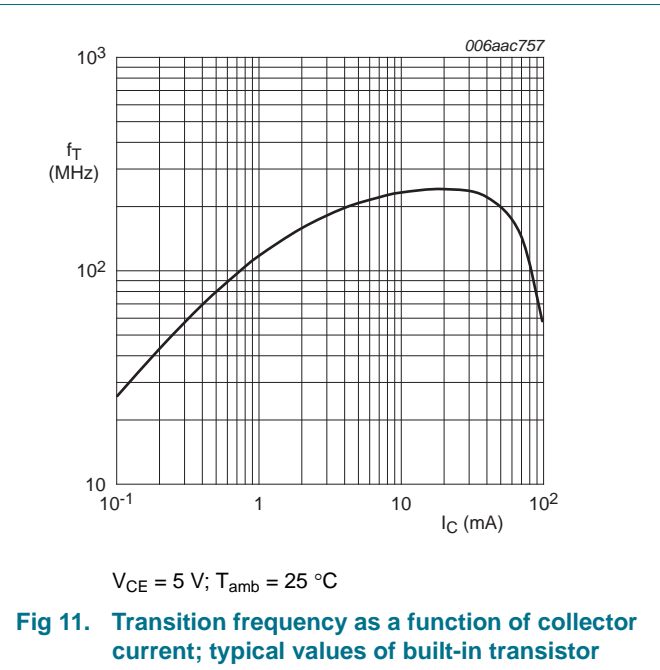
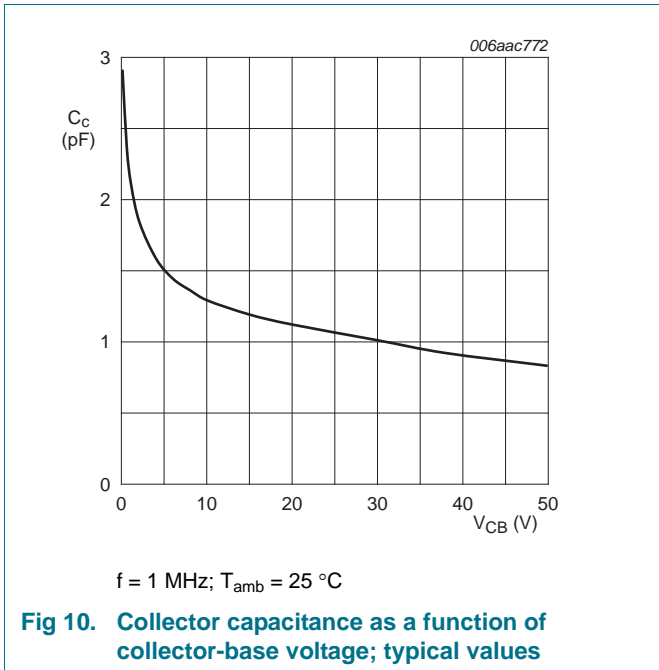

8. Test information

8.1 Quality information

This product has been qualified in accordance with the Automotive Electronics Council (AEC) standard Q101 - *Stress test qualification for discrete semiconductors*, and is suitable for use in automotive applications.

9. Package outline

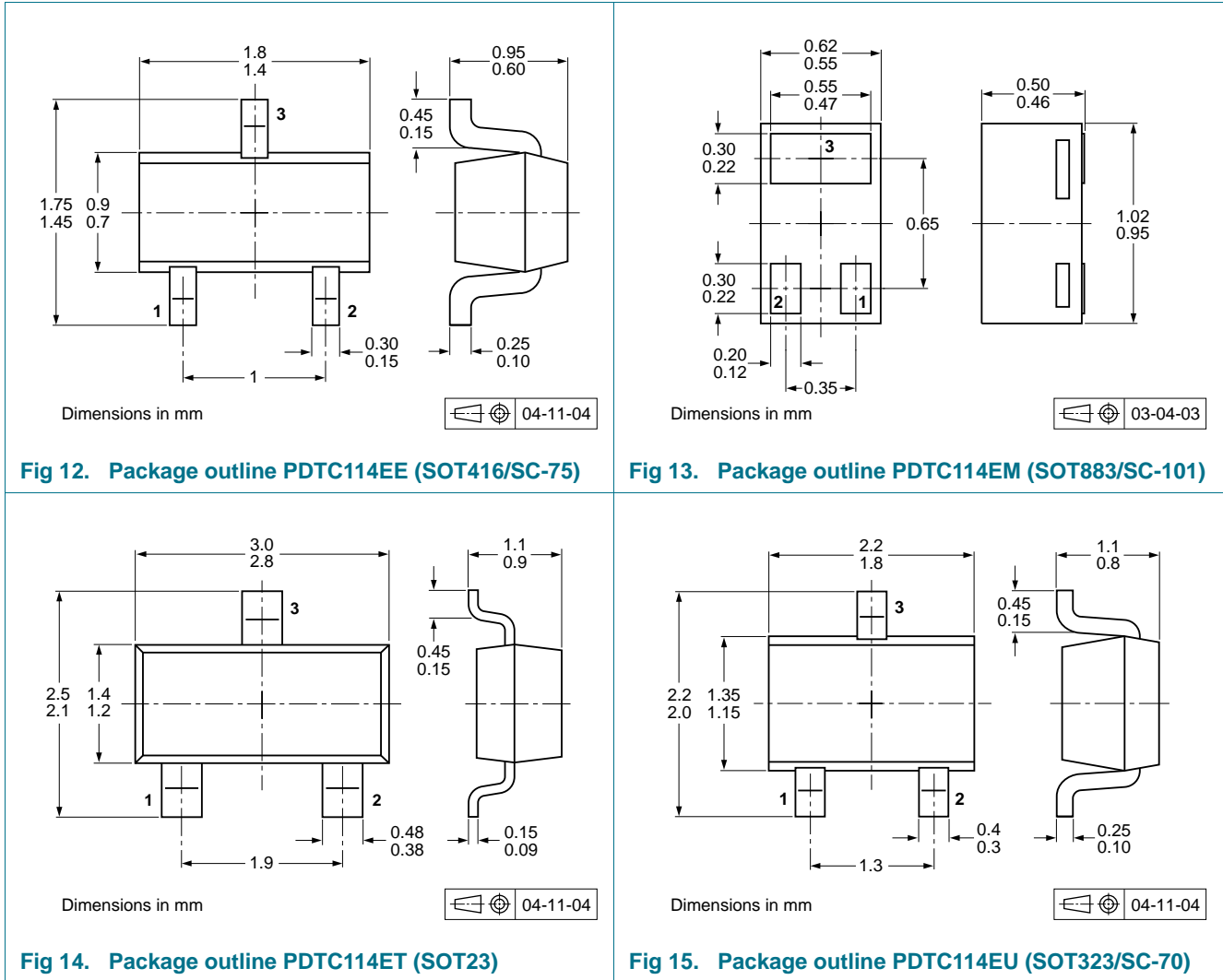

10. Packing information

Table 9. Packing methods

The indicated -xxx are the last three digits of the 12NC ordering code.^[1]

| Type number | Package | Description | Packing quantity | |
|-------------|---------|--------------------------------|------------------|-------|
| | | | 3000 | 10000 |
| PDTC114EE | SOT416 | 4 mm pitch, 8 mm tape and reel | -115 | -135 |
| PDTC114EM | SOT883 | 2 mm pitch, 8 mm tape and reel | - | -315 |
| PDTC114ET | SOT23 | 4 mm pitch, 8 mm tape and reel | -215 | -235 |
| PDTC114EU | SOT323 | 4 mm pitch, 8 mm tape and reel | -115 | -135 |

[1] For further information and the availability of packing methods, see [Section 14](#).

11. Soldering

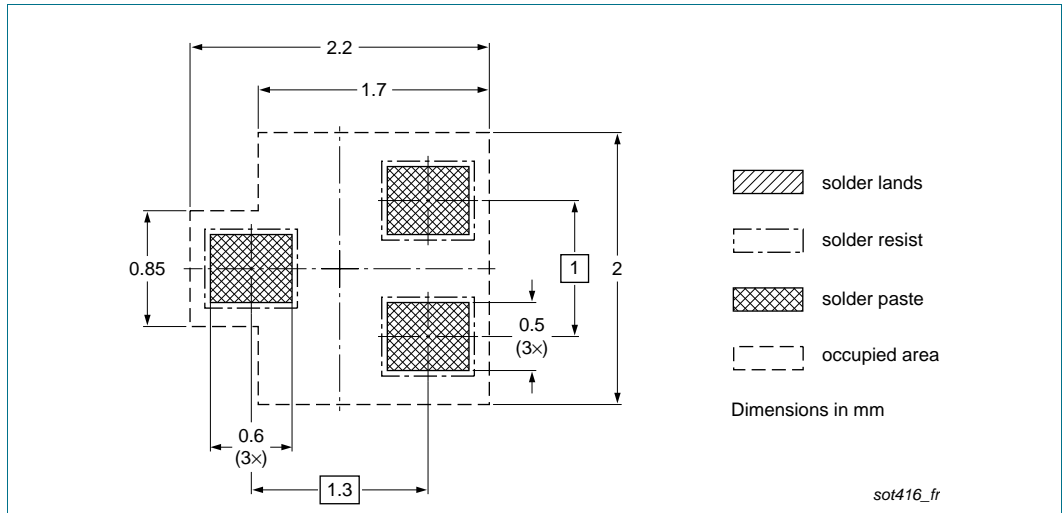

Fig 16. Reflow soldering footprint PDTC114EE (SOT416/SC-75)

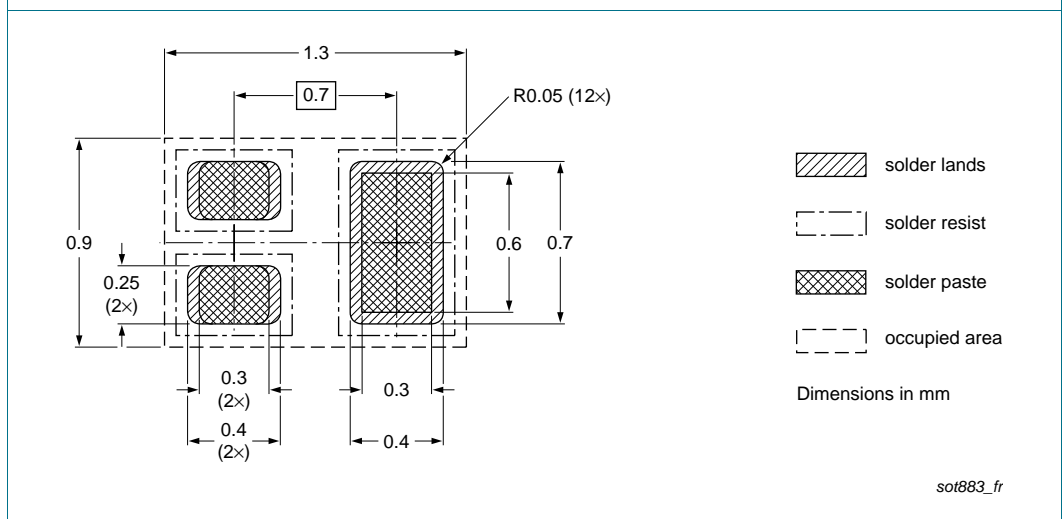

Fig 17. Reflow soldering footprint PDTC114EM (SOT883/SC-101)

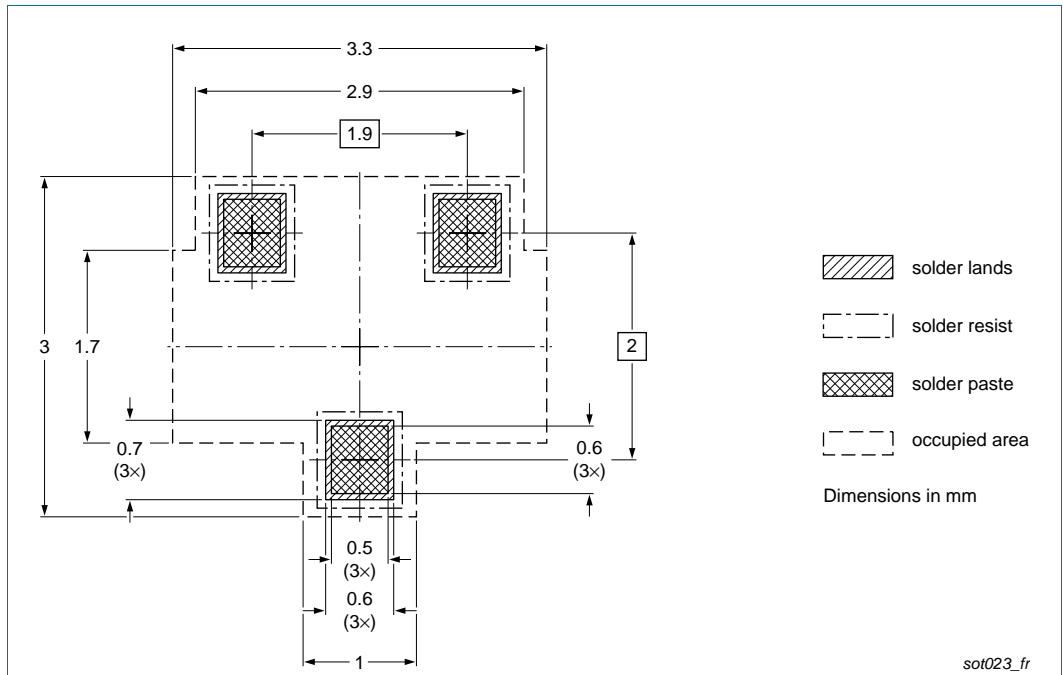

Fig 18. Reflow soldering footprint PDTC114ET (SOT23)

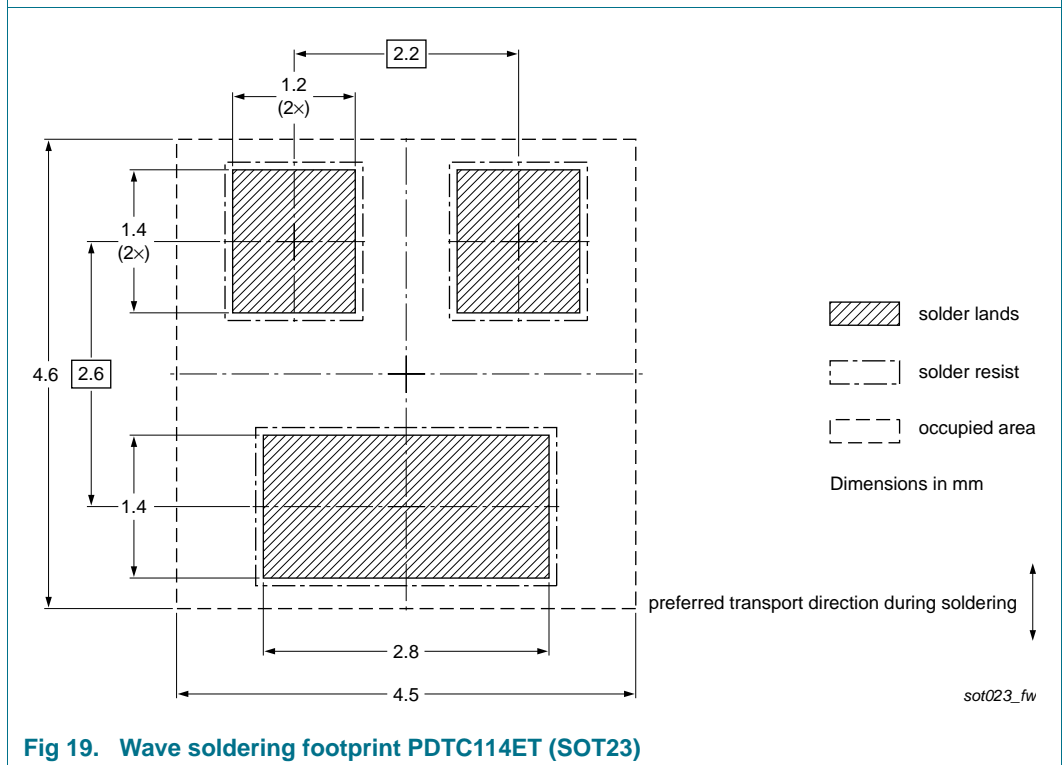

Fig 19. Wave soldering footprint PDTC114ET (SOT23)

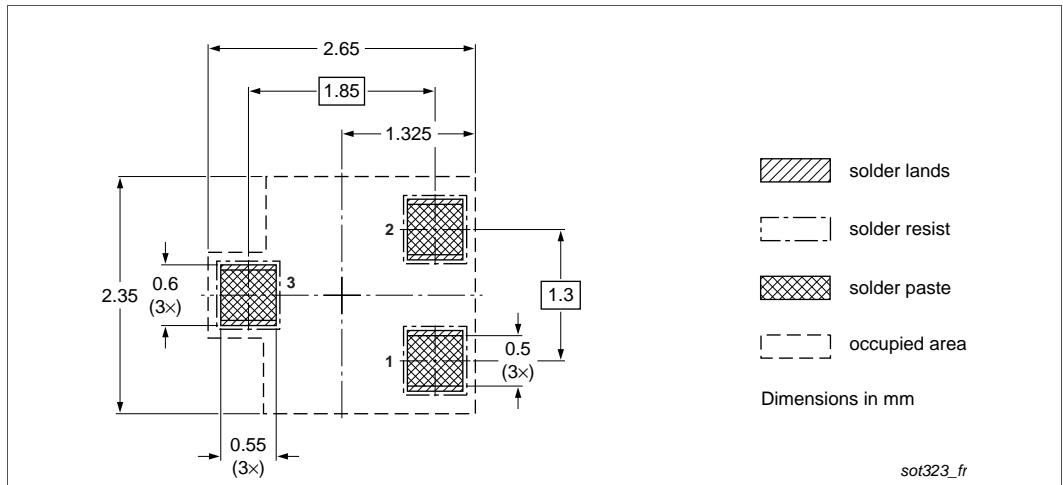

Fig 20. Reflow soldering footprint PDTC114EU (SOT323/SC-70)

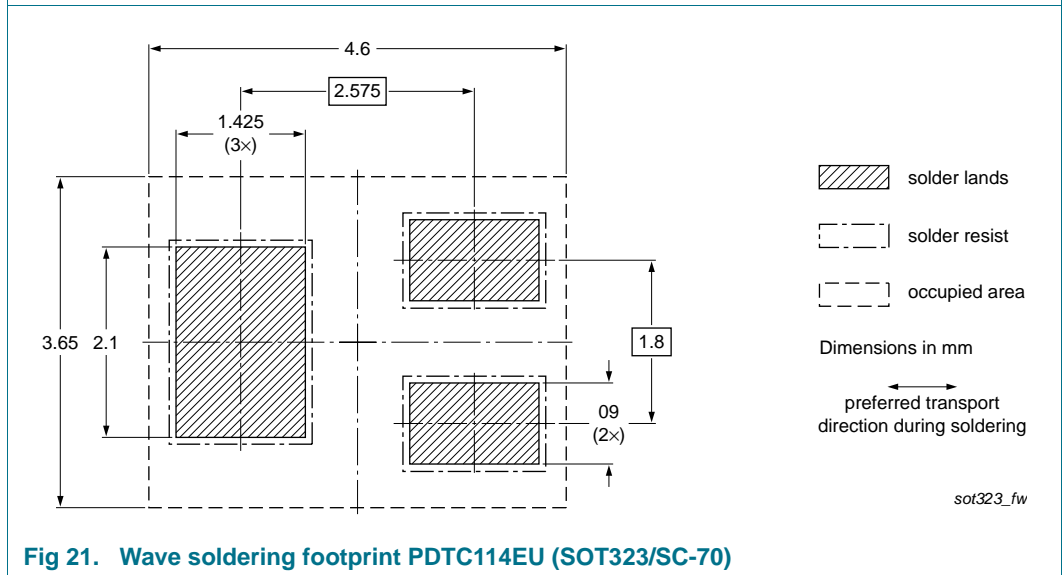

Fig 21. Wave soldering footprint PDTC114EU (SOT323/SC-70)

12. Revision history

Table 10. Revision history

| Document ID | Release date | Data sheet status | Change notice | Supersedes |
|----------------------|--|-----------------------|---------------|----------------------|
| PDTC114E_SER v.12 | 20111221 | Product data sheet | - | PDTC114E_SER v.11 |
| Modifications: | • Figure 3 and 5 : corrected | | | |
| PDTC114E_SER v.11 | 20111121 | Product data sheet | - | PDTC114E_SERIES v.10 |
| PDTC114E_SERIES v.10 | 20040805 | Product specification | - | PDTC114E_SERIES v.9 |
| PDTC114E_SERIES v.9 | 20030410 | Product specification | - | - |

13. Legal information

13.1 Data sheet status

| Document status ^{[1][2]} | Product status ^[3] | Definition |
|-----------------------------------|-------------------------------|---|
| Objective [short] data sheet | Development | This document contains data from the objective specification for product development. |
| Preliminary [short] data sheet | Qualification | This document contains data from the preliminary specification. |
| Product [short] data sheet | Production | This document contains the product specification. |

[1] Please consult the most recently issued document before initiating or completing a design.

[2] The term 'short data sheet' is explained in section "Definitions".

[3] The product status of device(s) described in this document may have changed since this document was published and may differ in case of multiple devices. The latest product status information is available on the Internet at URL <http://www.nxp.com>.

13.2 Definitions

Draft — The document is a draft version only. The content is still under internal review and subject to formal approval, which may result in modifications or additions. NXP Semiconductors does not give any representations or warranties as to the accuracy or completeness of information included herein and shall have no liability for the consequences of use of such information.

Short data sheet — A short data sheet is an extract from a full data sheet with the same product type number(s) and title. A short data sheet is intended for quick reference only and should not be relied upon to contain detailed and full information. For detailed and full information see the relevant full data sheet, which is available on request via the local NXP Semiconductors sales office. In case of any inconsistency or conflict with the short data sheet, the full data sheet shall prevail.

Product specification — The information and data provided in a Product data sheet shall define the specification of the product as agreed between NXP Semiconductors and its customer, unless NXP Semiconductors and customer have explicitly agreed otherwise in writing. In no event however, shall an agreement be valid in which the NXP Semiconductors product is deemed to offer functions and qualities beyond those described in the Product data sheet.

13.3 Disclaimers

Limited warranty and liability — Information in this document is believed to be accurate and reliable. However, NXP Semiconductors does not give any representations or warranties, expressed or implied, as to the accuracy or completeness of such information and shall have no liability for the consequences of use of such information. NXP Semiconductors takes no responsibility for the content in this document if provided by an information source outside of NXP Semiconductors.

In no event shall NXP Semiconductors be liable for any indirect, incidental, punitive, special or consequential damages (including - without limitation - lost profits, lost savings, business interruption, costs related to the removal or replacement of any products or rework charges) whether or not such damages are based on tort (including negligence), warranty, breach of contract or any other legal theory.

Notwithstanding any damages that customer might incur for any reason whatsoever, NXP Semiconductors' aggregate and cumulative liability towards customer for the products described herein shall be limited in accordance with the *Terms and conditions of commercial sale* of NXP Semiconductors.

Right to make changes — NXP Semiconductors reserves the right to make changes to information published in this document, including without limitation specifications and product descriptions, at any time and without notice. This document supersedes and replaces all information supplied prior to the publication hereof.

Suitability for use — NXP Semiconductors products are not designed, authorized or warranted to be suitable for use in life support, life-critical or safety-critical systems or equipment, nor in applications where failure or malfunction of an NXP Semiconductors product can reasonably be expected to result in personal injury, death or severe property or environmental damage. NXP Semiconductors and its suppliers accept no liability for inclusion and/or use of NXP Semiconductors products in such equipment or applications and therefore such inclusion and/or use is at the customer's own risk.

Applications — Applications that are described herein for any of these products are for illustrative purposes only. NXP Semiconductors makes no representation or warranty that such applications will be suitable for the specified use without further testing or modification.

Customers are responsible for the design and operation of their applications and products using NXP Semiconductors products, and NXP Semiconductors accepts no liability for any assistance with applications or customer product design. It is customer's sole responsibility to determine whether the NXP Semiconductors product is suitable and fit for the customer's applications and products planned, as well as for the planned application and use of customer's third party customer(s). Customers should provide appropriate design and operating safeguards to minimize the risks associated with their applications and products.

NXP Semiconductors does not accept any liability related to any default, damage, costs or problem which is based on any weakness or default in the customer's applications or products, or the application or use by customer's third party customer(s). Customer is responsible for doing all necessary testing for the customer's applications and products using NXP Semiconductors products in order to avoid a default of the applications and the products or of the application or use by customer's third party customer(s). NXP does not accept any liability in this respect.

Limiting values — Stress above one or more limiting values (as defined in the Absolute Maximum Ratings System of IEC 60134) will cause permanent damage to the device. Limiting values are stress ratings only and (proper) operation of the device at these or any other conditions above those given in the Recommended operating conditions section (if present) or the Characteristics sections of this document is not warranted. Constant or repeated exposure to limiting values will permanently and irreversibly affect the quality and reliability of the device.

Terms and conditions of commercial sale — NXP Semiconductors products are sold subject to the general terms and conditions of commercial sale, as published at <http://www.nxp.com/profile/terms>, unless otherwise agreed in a valid written individual agreement. In case an individual agreement is concluded only the terms and conditions of the respective agreement shall apply. NXP Semiconductors hereby expressly objects to applying the customer's general terms and conditions with regard to the purchase of NXP Semiconductors products by customer.

No offer to sell or license — Nothing in this document may be interpreted or construed as an offer to sell products that is open for acceptance or the grant, conveyance or implication of any license under any copyrights, patents or other industrial or intellectual property rights.

Export control — This document as well as the item(s) described herein may be subject to export control regulations. Export might require a prior authorization from competent authorities.

Quick reference data — The Quick reference data is an extract of the product data given in the Limiting values and Characteristics sections of this document, and as such is not complete, exhaustive or legally binding.

13.4 Trademarks

Notice: All referenced brands, product names, service names and trademarks are the property of their respective owners.

14. Contact information

For more information, please visit: <http://www.nxp.com>

For sales office addresses, please send an email to: salesaddresses@nxp.com

15. Contents

| | | |
|-----------|--|-----------|
| 1 | Product profile | 1 |
| 1.1 | General description | 1 |
| 1.2 | Features and benefits | 1 |
| 1.3 | Applications | 1 |
| 1.4 | Quick reference data | 1 |
| 2 | Pinning information | 2 |
| 3 | Ordering information | 2 |
| 4 | Marking | 2 |
| 5 | Limiting values | 3 |
| 6 | Thermal characteristics | 4 |
| 7 | Characteristics | 7 |
| 8 | Test information | 9 |
| 8.1 | Quality information | 9 |
| 9 | Package outline | 10 |
| 10 | Packing information | 10 |
| 11 | Soldering | 11 |
| 12 | Revision history | 14 |
| 13 | Legal information | 15 |
| 13.1 | Data sheet status | 15 |
| 13.2 | Definitions | 15 |
| 13.3 | Disclaimers | 15 |
| 13.4 | Trademarks | 16 |
| 14 | Contact information | 16 |
| 15 | Contents | 17 |

Please be aware that important notices concerning this document and the product(s) described herein, have been included in section 'Legal information'.

© NXP B.V. 2011.

All rights reserved.

For more information, please visit: <http://www.nxp.com>

For sales office addresses, please send an email to: salesaddresses@nxp.com

Date of release: 21 December 2011

Document identifier: PDTC114E_SER