

DESCRIPTION

The HFC0100 is a peak current mode controller with Green Mode Operation. Its high efficiency feature over the entire line and load range meets the stringent world-wide energy efficiency requirements.

The HFC0100 integrated with a high voltage current source, its valley detector ensures minimum Drain-Source voltage switching (Quasi-Resonant operation). When the output power falls below a given level, the controller enters the burst mode.

The HFC0100 features variable protections like Thermal Shutdown (TSD), Vcc Under voltage Lockout (UVLO), Over Load Protection (OLP), Over Voltage Protection (OVP).

The HFC0100 is available in the 8-pin SOIC8 package.

FEATURES

- Universal Main Input Voltage (85~265VAC)
- Quasi-Resonant Operation
- Valley Switching for high efficiency and EMI
- Active Burst Mode for low standby power consumption
- Internal High Voltage Current Source
- High level of integration, allows a very low number external component count
- Maximum Frequency Limited
- Internal Soft Start
- Internal 250nS Leading Edge Blanking
- Thermal shutdown (auto restart with hysteresis)
- Vcc Under Voltage Lockout with Hysteresis (UVLO)
- Over Voltage Protection
- Over Load Protection.

APPLICATIONS

- Battery charger: cellular phone, digital camera, video camera, electrical shaver, emergency lighting system, etc
- Standby power supply: CRT-TV, Projection-TV, LCD-TV, PDP-TV, Desk top PC, Audio system, etc
- SMPS: Inc jet printer, DVD player/recorder, VCR, CD player, Set top box, Air conditioner, refrigerator, washing machine, dish washer, Adapter for NB, etc

For MPS green status, please visit MPS website under Quality Assurance. "MPS" and "The Future of Analog IC Technology" are Registered Trademarks of Monolithic Power Systems, Inc.

TYPICAL APPLICATION

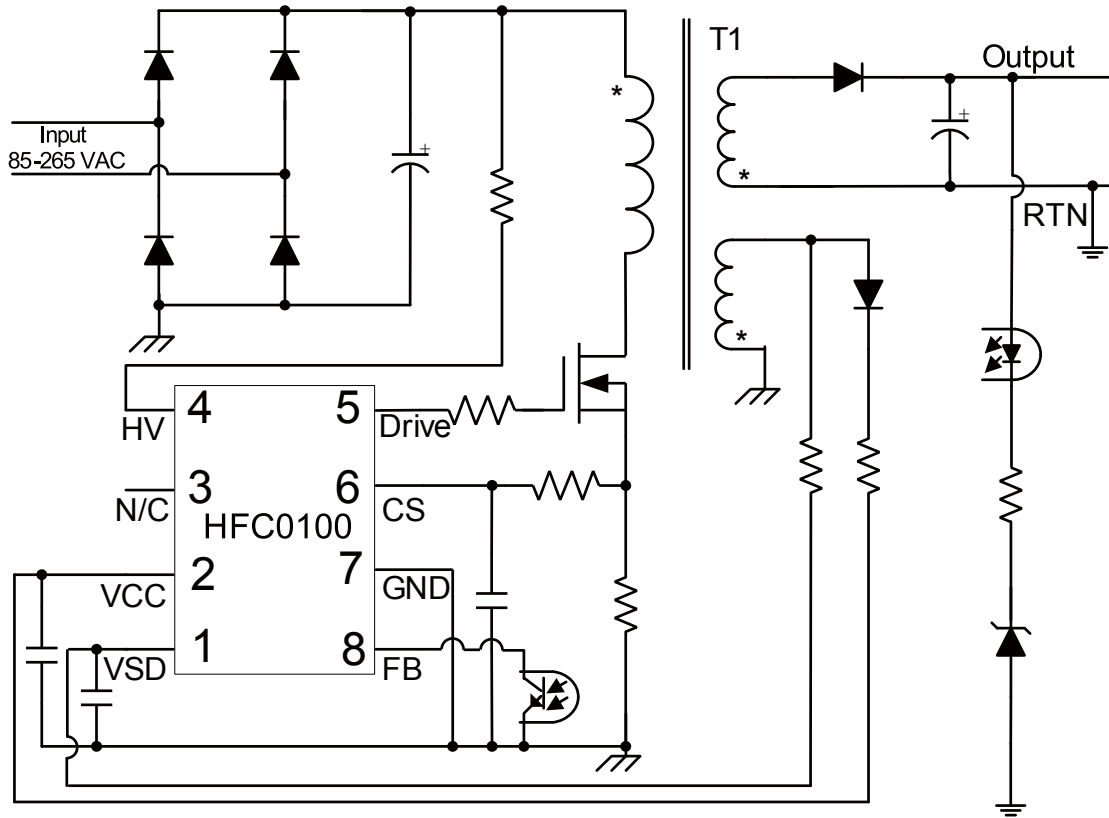

ORDERING INFORMATION

Part Number*	Package	Top Marking	Free Air Temperature (T _A)
HFC0100HS	SOIC8	HFC100	-40°C to +125°C

*For Tape & Reel, add suffix -Z (e.g. HFC0100HS-Z);
 For RoHS compliant packaging, add suffix -LF (e.g. HFC0100HS-LF-Z)

PACKAGE REFERENCE

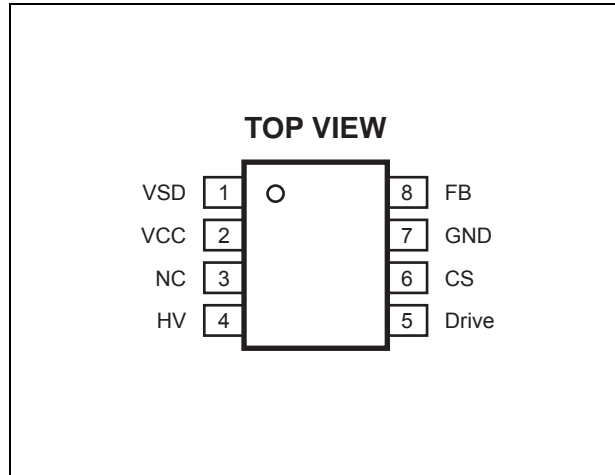

ABSOLUTE MAXIMUM RATINGS ⁽¹⁾

HV Break Down Voltage	-0.7V to 700V
Vcc, DRV to GND	-0.3V to 22V
FB, CS, VSD to GND	-0.3V to 7V
Continuous Power Dissipation...(T _A = +25°C) ⁽²⁾	1.3W
Junction Temperature	150°C
Thermal Shut Down	150°C
Thermal Shut Down Hysteresis	50°C
Lead Temperature	260°C
Storage Temperature	-60°C to +150°C
ESD Capability Human Body Model (All Pins except HV)	2.0kV
ESD Capability Machine Model	200V

Recommended Operation Conditions ⁽³⁾

Operating Vcc range	8V to 20V
Maximum Junction Temp. (T _J)	+125°C

Thermal Resistance ⁽⁴⁾	θ_{JA}	θ_{JC}
SOIC8	96	45 ... °C/W

Notes:

- Exceeding these ratings may damage the device.
- The maximum allowable power dissipation is a function of the maximum junction temperature T_J (MAX), the junction-to-ambient thermal resistance θ_{JA} , and the ambient temperature T_A. The maximum allowable continuous power dissipation at any ambient temperature is calculated by P_D (MAX) = (T_J (MAX)-T_A)/ θ_{JA} . Exceeding the maximum allowable power dissipation will cause excessive die temperature, and the regulator will go into thermal shutdown. Internal thermal shutdown circuitry protects the device from permanent damage.
- The device is not guaranteed to function outside of its operating conditions.
- Measured on JESD51-7, 4-layer PCB.

ELECTRICAL CHARACTERISTICS

For typical value $T_J=25^{\circ}\text{C}$

Parameter	Symbol	Conditions	Min	Typ	Max	Unit
Start-up Current Source (Pin HV)						
Charging current from Pin HV	I_{charge}	$V_{\text{CC}}=6\text{V}; V_{\text{HV}}=400\text{V}$	1.4	2	2.6	mA
Leakage current from Pin HV	I_{leak}	With auxiliary supply; $V_{\text{HV}}=400\text{V}$, $V_{\text{CC}}=13\text{V}$	--	20	--	μA
Break Down Voltage	V_{BR}		700	--	--	V
Supply Voltage Management (Pin Vcc)						
Vcc Upper Level at which the Internal High Voltage Current Source Stops	V_{CCH}		10.6	11.8	13	V
Vcc Lower Level at which the Internal High Voltage Current Source Triggers	V_{CCL}		7.2	8	8.8	V
Vcc Re-charge Level at which the protection occurs	V_{CCP}		--	5.5	--	V
Internal IC Consumption, 1nF Load on Drive Pin,	I_{CC1}	$F_s=100\text{kHz}$, $V_{\text{CC}}=12\text{V}$	--	2.0	--	mA
Internal IC Consumption, Latch off phase,	I_{CC2}	$V_{\text{CC}}=6\text{V}$	--	450	--	μA
Feedback Management (Pin FB)						
Internal Pull Up Resistor	R_{FB}		--	10	--	k Ω
Internal Pull Up Voltage	V_{UP}		--	4.5	--	V
FB Pin to Current Limit Division Ratio	I_{DIV}		--	3	--	--
Internal Soft-Start Time	T_{SS}		--	2.4	--	mS
FB Decreasing Level at which the controller enter the Burst Mode	V_{BURL}		--	0.5	--	V
FB Increasing Level at which the controller leave the Burst Mode	V_{BURH}		--	0.7	--	V
Over Load Set Point	V_{OLP}		--	3.7	--	V
Valley Switching Management (Pin VSD)						
Valley Switching Threshold Voltage	V_{VSD}		40	55	70	mV
Valley Switching Hysteresis	V_{HYS}		--	10	--	mV
Pin VSD Clamp Voltage	V_{VSDH}	High State; $I_{\text{pin2}}=3.0\text{mA}$	7	7.5	8	V
	V_{VSDL}	Low State; $I_{\text{pin2}}=-2.0\text{mA}$	-0.8	-0.65	-0.5	
Valley Switching Propagation Delay	T_{VSD}	Pull down from 2V to -100mV	120	160	200	nS
Minimum Off Time	T_{min}		6.6	7.8	9	μS
Re-start time After Last Valley detect Transition	T_{restart}		--	4.6	--	μS
OVP Sampling Delay	T_{OVPS}		--	3.5	--	μS
Pin VSD OVP reference level	V_{OVP}		--	6	--	V
Internal Impedance	R_{int}		--	24	--	k Ω
Current Sampling Management (Pin CS)						
Leading Edge Blanking	T_{LEB}		--	250	--	nS
Driving Signal (Pin DRIVE)						
Sourcing Resistor	R_{H}		--	17	--	Ω
Sinking Resistor	R_{L}		--	7	--	Ω

PIN FUNCTIONS

Pin #	Name	Description
1	VSD	Input from the auxiliary flyback signal, it ensures discontinuous operation and valley switching. It also offers a fixed OVP detection.
2	Vcc	Supply voltage Pin. This pin is connected to an external bulk capacitor of typically 22uf and a ceramic capacitor of typically 0.1uF.
3	N/C	This Pin ensures adequate creepage distance.
4	HV	Input for the start up current unit.
5	Drive	Output of the driving signal.
6	CS	Input of the current sense.
7	GND	Ground.
8	FB	The Pin sets the peak current limit, by connecting an optocoupler to this Pin. A feedback voltage of 3.7V will trigger an over load protection, and a feedback voltage of 0.5V will trigger a burst mode operation.

TYPICAL PERFORMANCE CHARACTERISTICS

T_A=25°C

IC Consumption Vs V_{CC} (No Output Load)

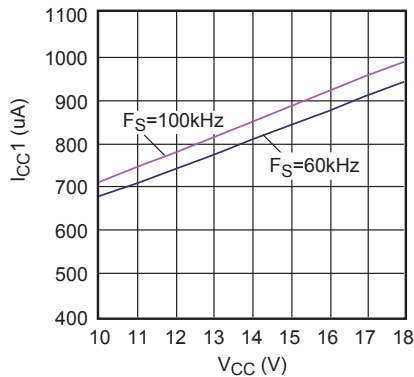

IC Consumption Vs V_{CC} (1nF Output Load)

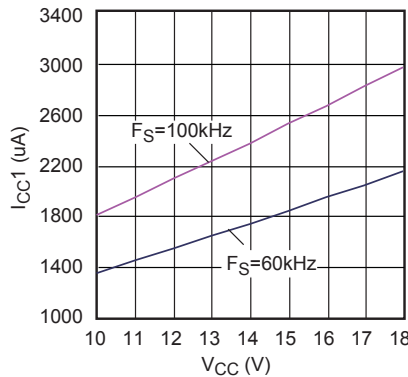

Charging Current From Pin HV (V_{CC}=6V, V_{HV}=400V) Vs Temperature

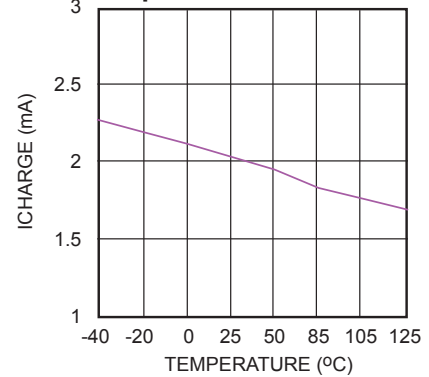

V_{CC} Upper Level at which the Internal High Voltage Current Source Stops Vs Temperature

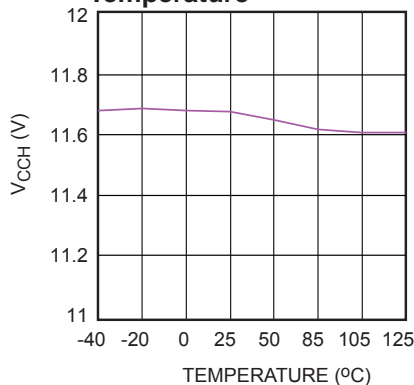

V_{CC} Lower Level at which the Internal High Voltage Current Source Triggers Vs Temperature

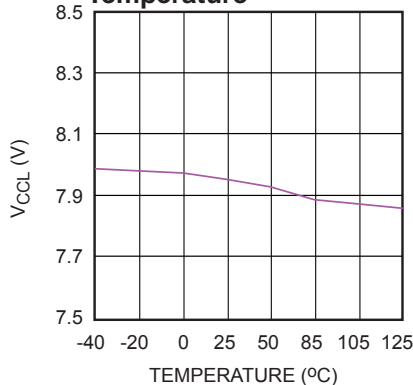

Pin FB Internal Pull Up Resistor Vs Temperature

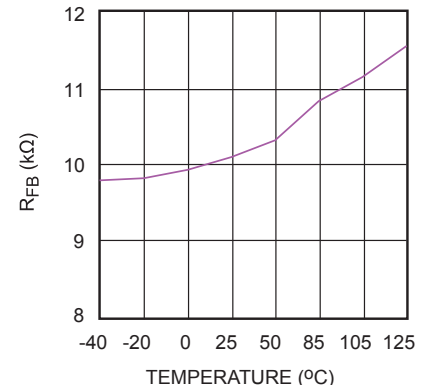

Over Load Set Point Vs Temperature

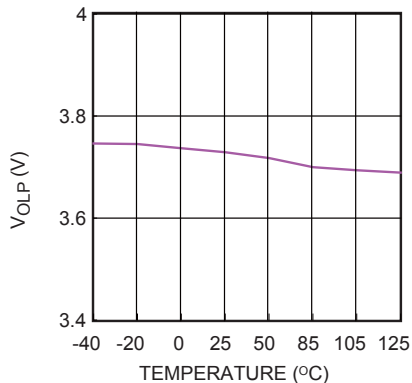

Valley Switching Threshold Voltage Vs Temperature

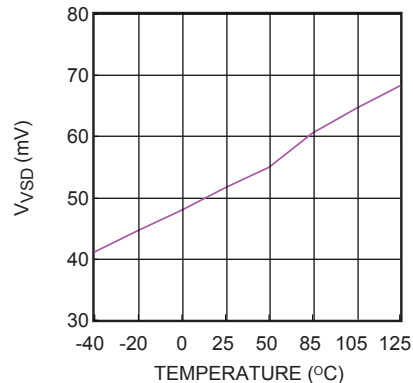

Minimum Off Time Vs Temperature

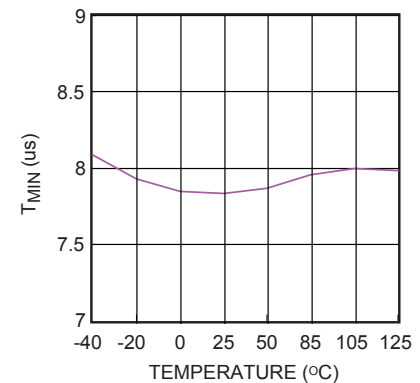

TYPICAL PERFORMANCE CHARACTERISTICS *(continues)*

$T_A=25^{\circ}\text{C}$

OVP Sampling Delay Vs Temperature

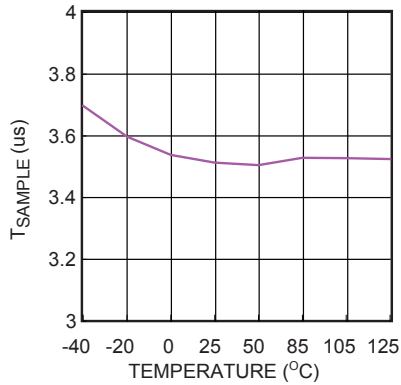

Pin VSD OVP reference level Vs Temperature

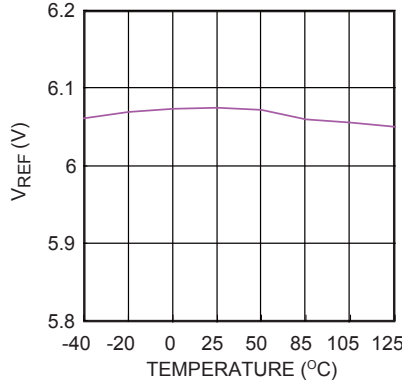

Pin VSD Internal Impedance Vs Temperature

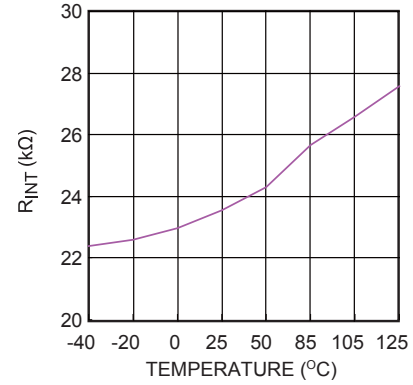

Sourcing Resistor Vs Temperature

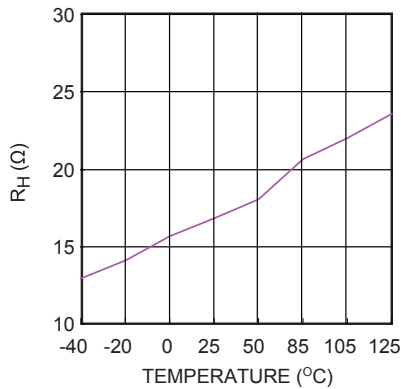

Sinking Resistor Vs Temperature

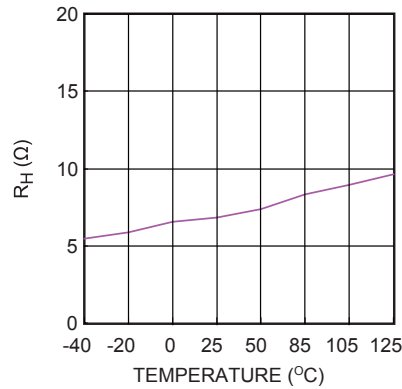

FB Decreasing Level at which the controller enter the Burst Mode Vs Temperature

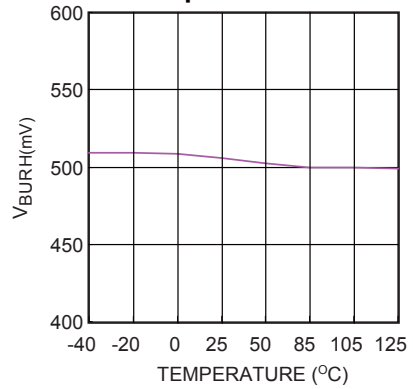

FB Increasing Level at which the controller leave the Burst Mode Vs Temperature

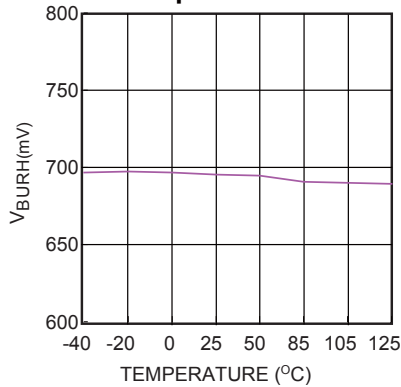

BLOCK DIAGRAM

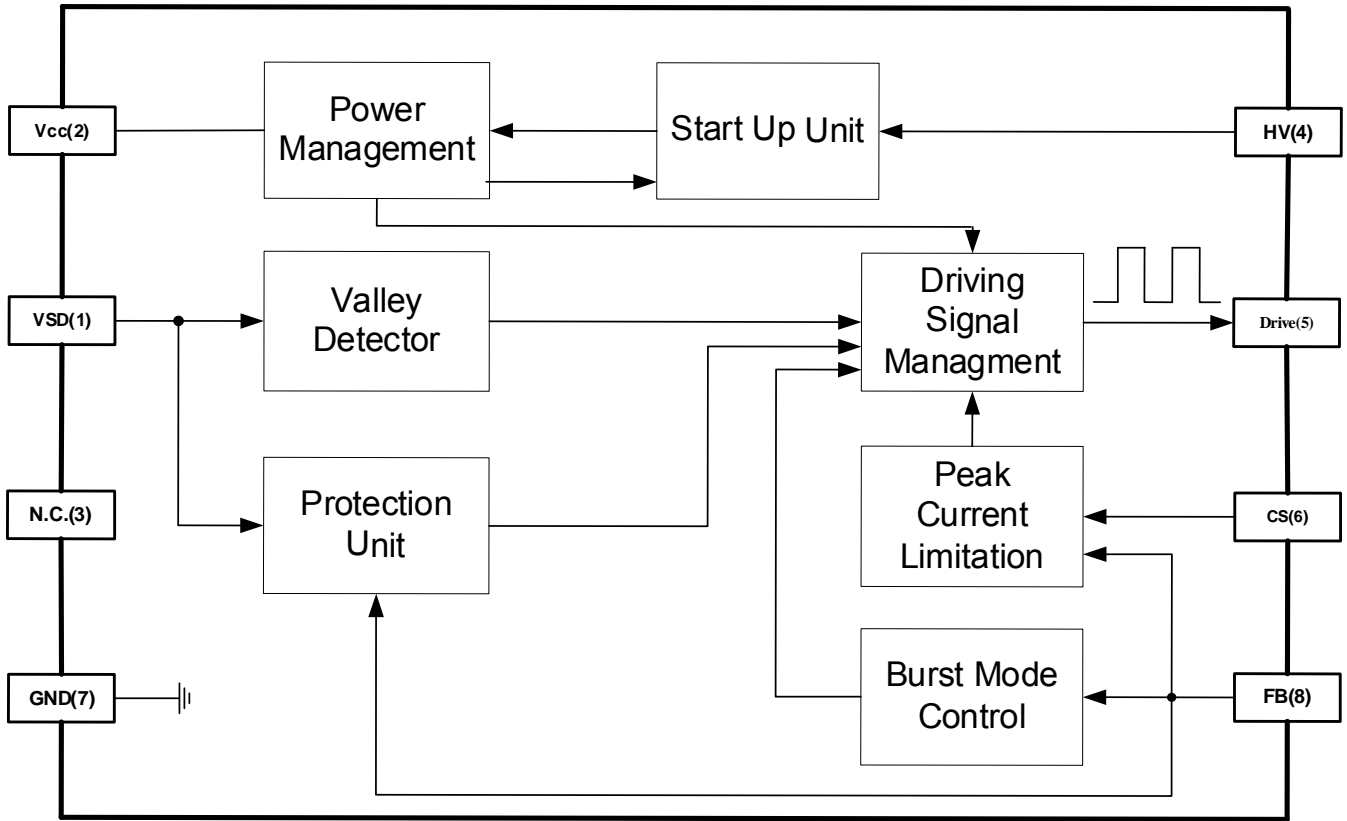

Figure 1— Block Diagram

OPERATION

The HFC0100 incorporates all the necessary features needed to a reliable Switch Mode Power Supply. Its valley detector ensures minimum Drain-Source voltage switching (Quasi-Resonant operation). When the output power falls below a given level, the regulator enters the burst mode. An internal minimum off time limiter prevents the free running frequency to exceed 150kHz.

Start-Up

Initially, the IC is self supplying from the internal high voltage current source unit which drawn from the HV pin.

The IC starts switching and the internal high voltage current source unit is stopped as soon as the voltage on Pin Vcc reaches the threshold $V_{CCH} = 11.8V$.

Before the supply is taken over by the auxiliary winding of the transformer, the Vcc capacitor supplies HFC0100 to maintain Vcc.

Quasi-Resonant Operation

The HFC0100 operates in Discontinuous Conduction Mode (DCM). The valley detector ensures minimum Drain-Source voltage switching (Quasi-Resonant operation)

As a result, there are virtually no primary switch turn on losses and no secondary diode recovery losses. It ensures the reduction of the EMI noise.

Figure2 shows the valley detector unit.

When the voltage:

$$(V_{DS} - V_{in}) \times \frac{N_{aux}}{N_{pri}} \times \frac{24k\Omega}{24k\Omega + R_{VSD}} < 55mV$$

V_{DS} —Drain Source Voltage of the primary FET

V_{IN} —Input Voltage

N_{aux} —Auxiliary Winding Turns of the transformer

N_{pri} —Primary Winding Turns of the transformer

The valley detector sends out a valley signal to turn on the primary FET.

Figure3 shows a typical drain source voltage waveform with valley switching.

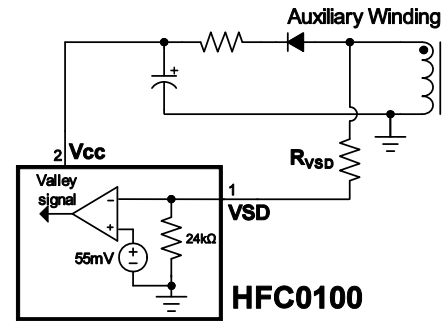

Figure 2—Valley Detector

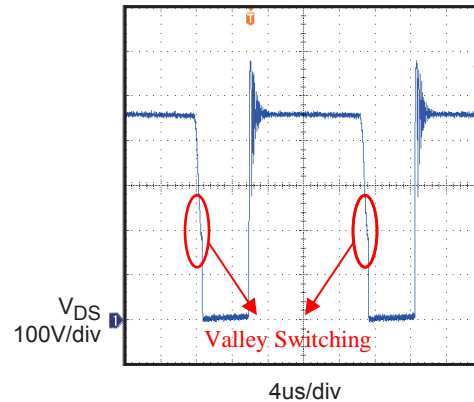

Figure 3—Valley Switching

To ensure the switching frequency below the EN55022 start limit---150kHz, HFC0100 employs an internal minimum off time limiter---7.8μs, shows as figure 4.

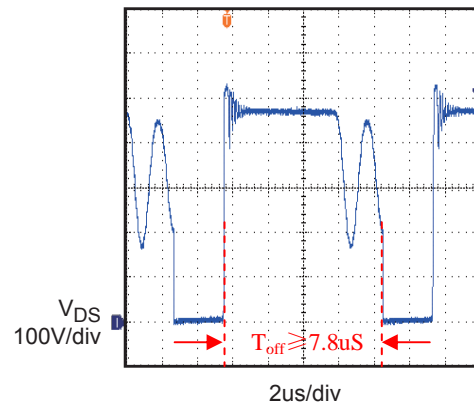

Figure 4—Minimum Off Time Limit

V_{CC} Under-Voltage Lock-out

When the V_{CC} below the UVLO threshold-8V, the HFC0100 stops switching and the internal high voltage current source re-starts, the V_{CC} external bulk capacitor is re-charged by it.

Figure 5 shows the typical waveform with V_{CC} under voltage lock out.

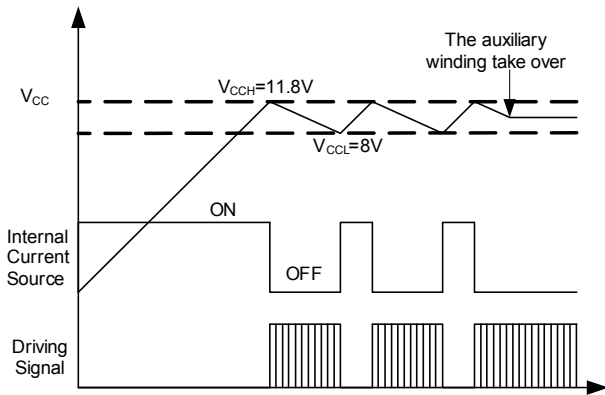

Figure 5—V_{CC} Under-Voltage Lock Out

Over-Voltage Protection (OVP)

The positive plateau of auxiliary winding voltage is proportional to the output voltage, the OVP use the auxiliary winding voltage instead of directly monitoring the output voltage.

The Figure 6 shows the OVP sample unit.

If the voltage:

$$V_O \times \frac{N_{aux}}{N_{SEC}} \times \frac{24k\Omega}{24k\Omega + R_{VSD}} > 6V$$

V_O—Output voltage

N_{aux}—Auxiliary Winding Turns of the transformer

N_{SEC}—Secondary Winding Turns of the transformer

The OVP circuit is triggered, and the HFC0100 stops the switching cycle and goes into latched fault condition. The controller stays fully latched in this position until the V_{CC} is decreased down to 3V, e.g. when the user unplugs the power supply and re-plugs it.

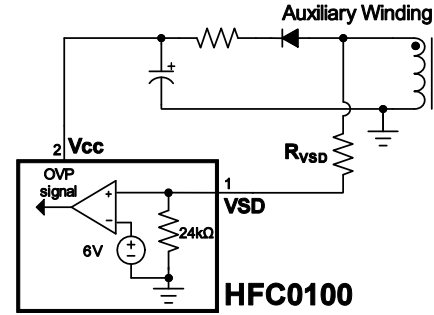

Figure 6—OVP Sample Unit

To avoid the mis-trigger due to the oscillation of the leakage inductance and the parasitic capacitance, the OVP sampling has a T_{OVPS} blanking, typical 3.5μS, shows as Figure 7.

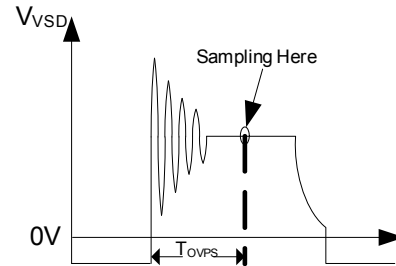

Figure 7

Over Load Protection (OLP)

The maximum output power is limited by the maximum switching frequency and maximum primary peak current. If the output consumes more than the maximum output power, the output voltage is drawn below the set point, this reduces the current through the optocoupler LED, which also reduces the transistor current, thus increases the FB voltage.

By continuously monitoring the Pin FB voltage, when the feedback voltage exceeds the threshold V_{OLP}—3.7V, it shuts off the switching cycle. The HFC0100 enters a safe low power operation that prevents from any lethal thermal or stress damage. As soon as the default disappears, the power supply resumes operation.

During the start up or load transient, the FB voltage will be high enough temporarily to mis-trigger the OLP, to prevent this undesired protection, OLP circuit is designed to be triggered after V_{CC} is decreased below 8.5V.

Burst Operation

To minimize the power dissipation in no load or light load, the HFC0100 enters the burst mode operation. As the load decreases, the FB voltage decreases, the HFC0100 stops the switching cycle when the FB voltage drops below the threshold V_{BURL} —0.5V. And the output voltage starts to drop at a rate dependent on the load. This causes the FB voltage to rise again. Once the FB voltage exceeds the threshold V_{BURH} —0.7V, switching resumes. The FB voltage then falls and rises repeatedly. The burst mode operation alternately enables and disables switching cycle of the MOSFET thereby reducing switching loss in the no load or light load conditions.

Figure 8 shows the typical FB and Drive waveform during the burst mode.

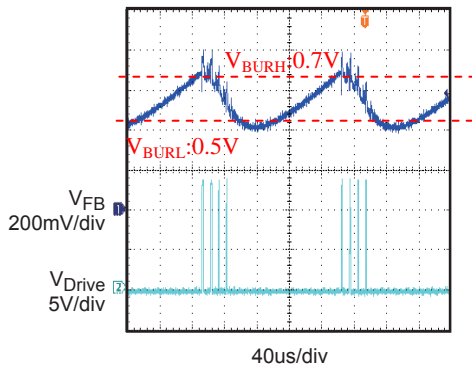

Figure 8—Burst Mode

Thermal Shutdown (TSD)

To prevent from any lethal thermal damage. The HFC0100 shuts down switching cycle when the inner temperature exceeds 150DegC. As soon as the inner temperature drops below 100DegC, the power supply resumes operation.

Soft-Start

To reduce the stress on primary MOSFET and secondary diode during start up, to smoothly establish the output voltage, the HFC0100 has an internal soft-start circuit that increases the current comparator inverting input voltage, together with the MOSFET current, slowly after it starts up. The pulse width to the power switching device is progressively increased to establish the correct working conditions for transformers, inductors, and capacitors.

Current Limit Setting

The switch current is sensed by the resistor series between the Source of the FET and the ground. And the current limit is determined by the FB signal, $V_{Limit} = \frac{V_{FB}}{I_{div}} = \frac{V_{FB}}{3}$. To limit the maximum output power, the current limit is clamped at 1V when V_{FB} is bigger than 3.3V.

Leading Edge Blanking

In order to avoid the premature termination of the switching pulse due to the parasitic capacitance, an internal leading edge blanking (LEB) unit is employed between the CS Pin and the current comparator input. During the blanking time, the path, CS Pin to the current comparator input, is blocked. Figure 9 shows the leading edge blanking.

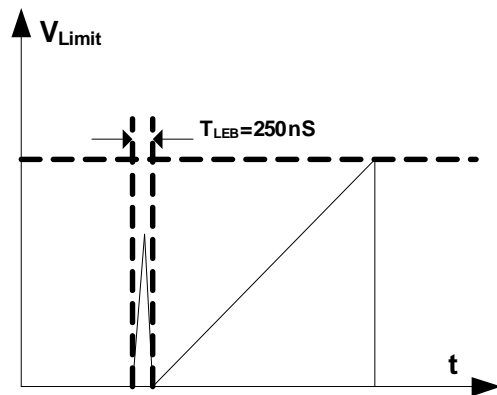

Figure 9—Leading Edge Blanking

Over Power Compensation

In the case of current sensing, as shown in figure 10, the turn off of the FET is delayed due to the propagation delay of the control circuit, the delay time is the inherent characteristic of the control circuit, so T_{delay} can be seen fixed. This delay will cause an overshoot of the peak current. ΔI_2 is bigger than ΔI_1 due to the bigger rising ratio (the higher input voltage, the bigger rising ratio).

The propagation delay is done by means of the feedforward resistor, shown as Figure 11. Through this method, adding one offset voltage at CS pin (the higher input voltage, the bigger offset voltage.).

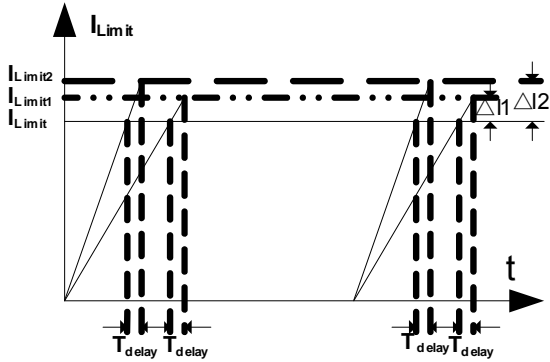

Figure 10—Propagation delay of the current limit

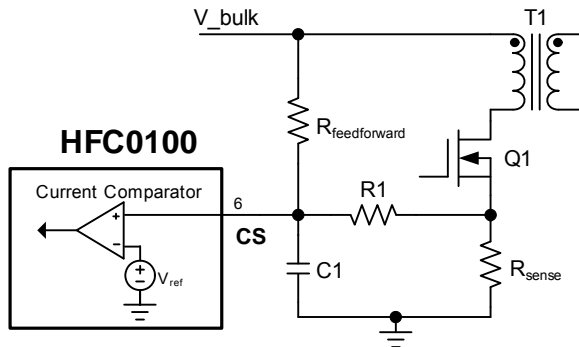

Figure 11—Over Power Compensation

Figure 12 shows the HFC0100 control flow chart.

Figure 13 shows the HFC0100 evolution of the signals in presence of faults

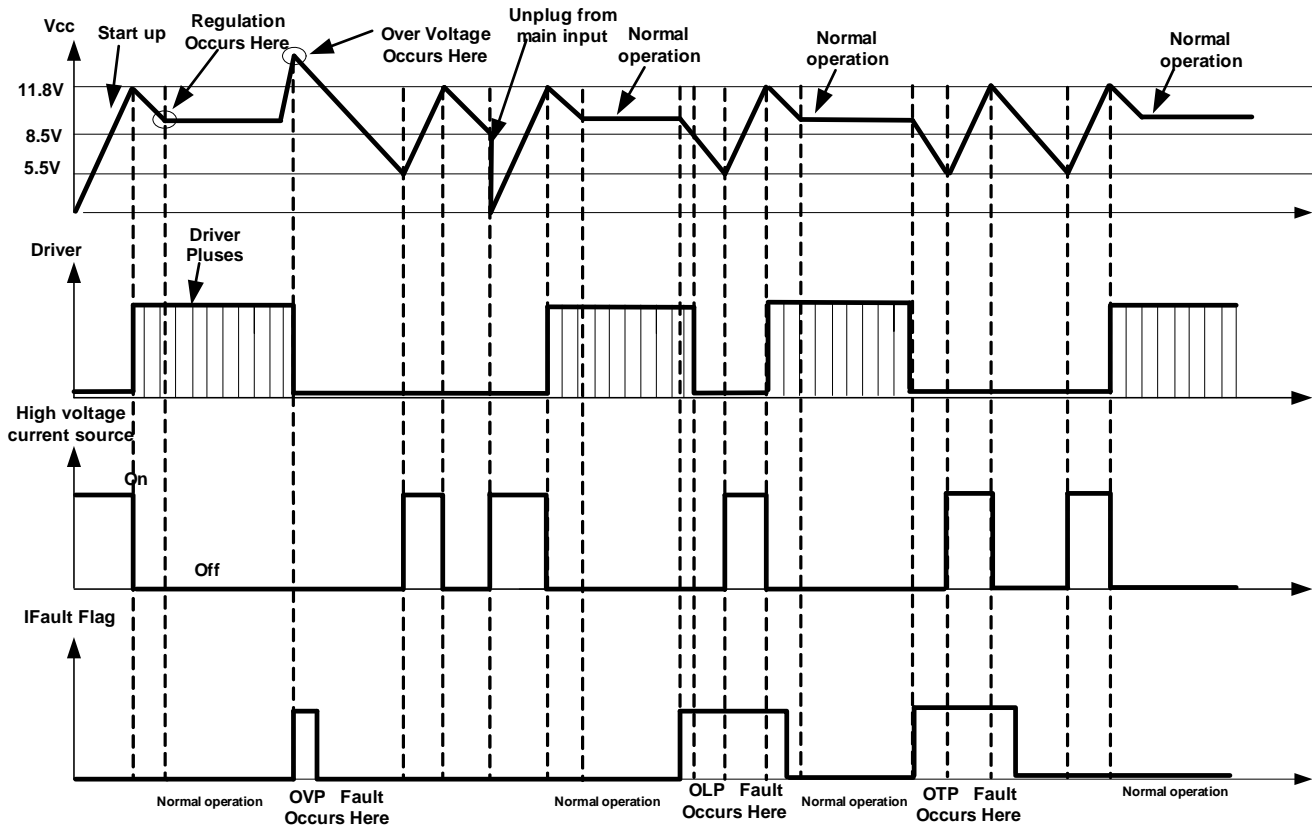
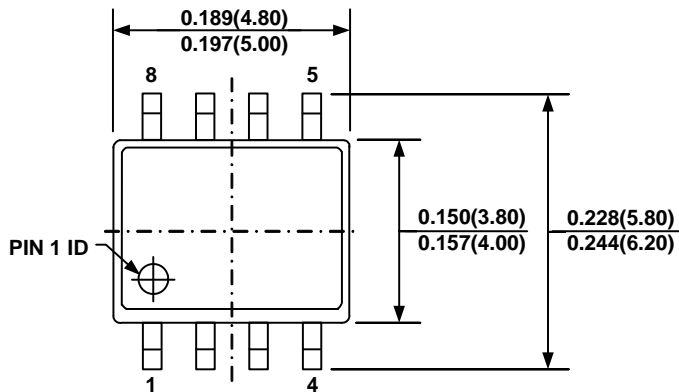
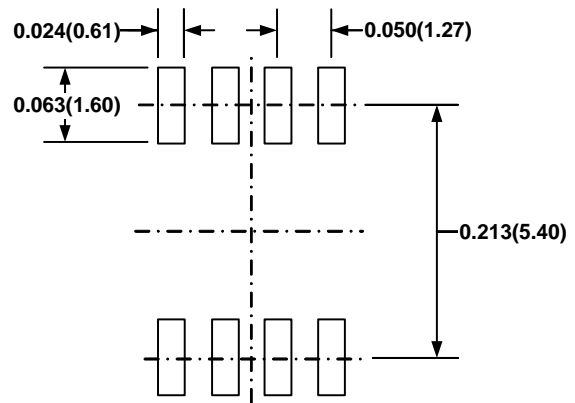
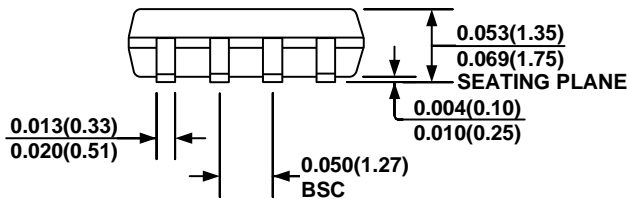
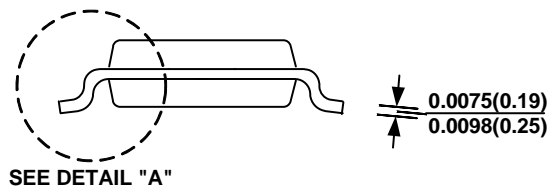
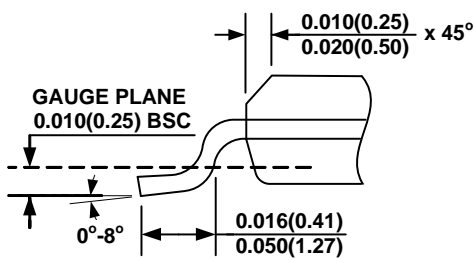

Figure 13—Evolution of the Signals in Presence of Faults

PACKAGE INFORMATION
SOIC8

TOP VIEW

RECOMMENDED LAND PATTERN

FRONT VIEW

SIDE VIEW

DETAIL "A"
NOTE:

- 1) CONTROL DIMENSION IS IN INCHES. DIMENSION IN BRACKET IS IN MILLIMETERS.
- 2) PACKAGE LENGTH DOES NOT INCLUDE MOLD FLASH, PROTRUSIONS OR GATE BURRS.
- 3) PACKAGE WIDTH DOES NOT INCLUDE INTERLEAD FLASH OR PROTRUSIONS.
- 4) LEAD COPLANARITY (BOTTOM OF LEADS AFTER FORMING) SHALL BE 0.004" INCHES MAX.
- 5) DRAWING CONFORMS TO JEDEC MS-012, VARIATION AA.
- 6) DRAWING IS NOT TO SCALE.

NOTICE: The information in this document is subject to change without notice. Users should warrant and guarantee that third party Intellectual Property rights are not infringed upon when integrating MPS products into any application. MPS will not assume any legal responsibility for any said applications.