

DIN CONNECTORS (AXD)

Panasonic
ideas for life

**CONNECTORS FOR
PC BOARD TO PC BOARD**

**DIN CONNECTORS
(AXD)**

DIN Connector conforming to DIN/IEC standards

UL
(for B and C type) 



FEATURES

1. 2 pieces connectors conforming to DIN 41612 and IEC 603-2.

2. Clip contact with reliable construction on both sides for highly reliable contact.

- 1) Withstands vibration and shock.
- 2) Long insertion/removal life and insertion/removal force is stable.
- 3) Construction able to withstand unreasonable twisting when inserting and removing.

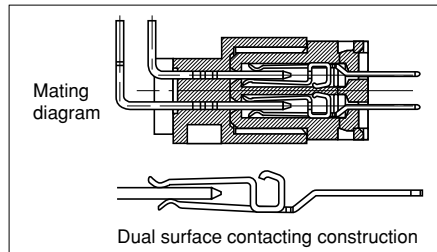

3. Supports time difference contact function.

- 1) ICs are protected from damage at connection even if the PC board is inserted or removed without power connected during maintenance or inspection. This simplifies circuit design.
- 2) Time difference contacts can be arranged as desired.
- 3) Possible for either header or socket.

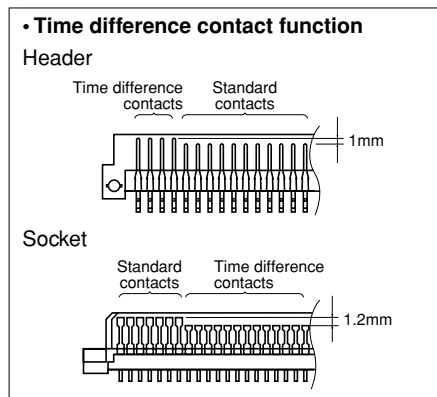

4. Plenty of products with improved functions

The following types are available in addition to ones with the time difference contact function.

- Flux-tight type that prevents flux from creeping up from the connector bottom and terminals.
- Self-clinching bracket, PC board top mounting type.

5. Constructed to prevent incorrect insertion.

The construction is designed to prevent reverse insertion of the connector according to the DIN standard. We have taken further measures with a dedicated key that enables the easy prevention of incorrect insertion of connectors with identical poles.

Incorrect insertion prevention key

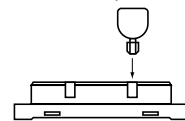

6. Compliance with RoHS' Directive
Environmentally friendly, the connectors' comply with Europe's RoHS' Directive. Cadmium, lead, mercury, hexavalent, chromium, PBB and PBDE are not used.

APPLICATIONS

PBX, Factory Automation Equipment

ORDERING INFORMATION

AXD

DIN connectors

- 1: Socket
2: Header

<No. of contacts (2 digits)>

20: 20 contacts 32: 32 contacts 44: 44 contacts
50: 50 contacts 64: 64 contacts 90: 90 contacts
96: 96 contacts 00: 100 contacts

<Type and contacts layout>

- 2: B type (2 rows terminal pitch: 2.54 mm)
3: C type (The middle row is removed terminal pitch: 5.08 mm)
4: C type (3 rows terminal pitch: 2.54 mm)
6: R type (The middle row is removed terminal pitch: 5.08 mm)
7: R type (3 rows terminal pitch: 2.54 mm)
8: Q type (2 rows terminal pitch: 2.54 mm)

<Terminal shape and product types>

No.	PC board mounting form	Self-clinching bracket	Flux resistant	Terminal shape
0	PC board top mounting type	Not available	Not available	DIP terminal
2			Available	
5		Available	Not available	
7			Available	
1	PC board edge mounting type	Not available	Not available	

<Surface treatment (Contact portion/Terminal portion)>

- 1: Au plating/Sn plating

SPECIFICATIONS

1. Characteristics

Item		Specifications	Conditions
Electrical characteristics	Rated current	2A	
	Rated voltage	300V AC	
	Breakdown voltage	1,000 V AC for 1 min.	Detection current: 1mA
	Insulation resistance	Min. 1,000MΩ	at 500V DC megger
	Contact resistance	Max. 20mΩ	Measured based on the HP4338B measurement method of JIS C 5402.
Mechanical characteristics	Composite insertion force	Max. 0.843N {86gf} × no. of contact	
	Unit removal force	Min. 0.15N {15.3gf}	Measured by steel gauge with 0.56(t)×0.8(W)mm and smoothness 0.1s.
	Post holding force	Min. 19.6N {2kgf} (header side)	
Lifetime characteristics	Insertion and removal life	1,000 times	
Environmental characteristics	Ambient temperature	-55°C to +125°C	At less than 85% R.H. (No freezing at low temperature)
	Soldering temperature resistance	260°C: within 10 sec. 300°C: within 5 sec. 350°C: within 3 sec.	

2. Material and surface treatment

Part name	Material	Surface
Molded portion	Glass reinforced PBT (UL94V-0)	—
Socket contact	Copper alloy	Contact portion: Ni plating on base, Au plating on surface Terminal portion: Ni plating on base, Sn plating on surface
Header post	Brass	Contact portion: Ni plating on base, Au plating on surface Terminal portion: Ni plating on base, Sn plating on surface

Note) Please consult us for different plating requirements.

3. Applicable PC board

PC board thickness	Applicable connector types	Thickness
1.6 to 2.4mm	B, C type socket Q, R type header	1.6mm
	B, C type header Q, R type socket	

DIN CONNECTORS (AXD)

INTRODUCTION OF OTHER TYPES

1. FEATURES OF REVERSE TYPE DIN CONNECTOR

New series of reverse types popular in the U.S.A.

1) Shock resistant socket construction
Integrated construction of the flange and housing prevent damage to the terminals from shock.

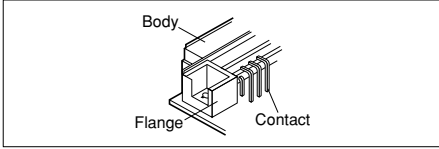

2) Box-shaped header provides excellent electrical performance

Box-shaped headers feature long insulation distance between the connector and mounting panel and low capacitance.

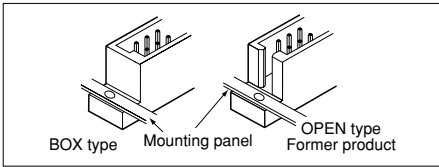

Standard type and reverse type

Types	Header/ socket	Terminal shape	Form	
Standard type	Header	Angle		The contacts of the socket mounted on the mother board (power supply side) are covered to prevent electrical shock and entry of foreign matter.
	Socket	Straight		
Reverse type	Header	Straight		1. Reduction of total cost Since the cost of the header is low, it is more economical to use the header for mother boards which require multiple pins for expansion. 2. Matches the designer's requirements for maximum simplicity in the mother board design.
	Socket	Angle		

The header and socket for the standard type and reverse type fit each other, this permits the connections shown in the figure on the right.

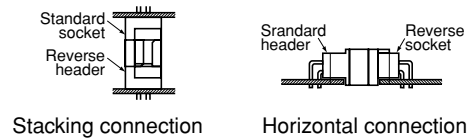

2. FEATURES AND CONSTRUCTION OF DIN CONNECTOR WITH HIGHER FUNCTION

DIN connector enhancement products which support user circuit designs and solve problems that occur during connector mounting.

- PC board top mounting type
- Self-clinching bracket (with temporary fastening function)
- Flux resistant construction
- Time difference contacts

1) PC board top mounting type

- Prevents the entry of flux during automatic soldering.
- Large position tolerance when mounting the connector to the PC board permits the use of automatic mounting.

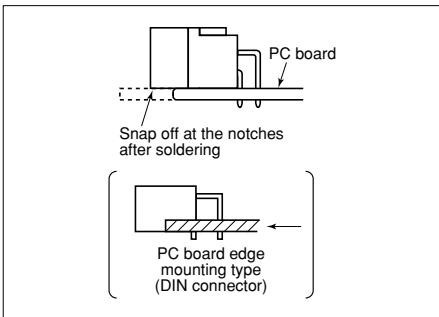

2) Self-clinching brackets

(with temporary function)

- Prevents the connector from shifting due to vibration and shock.
- Uses the same mounting hole as the mounting screw.

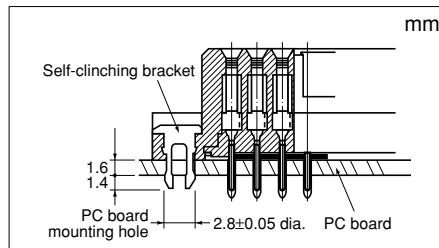

3) Flux resistant construction

The terminals are sealed with resin to prevent seepage of flux through the terminals or entry of flux from the bottom of the connector.

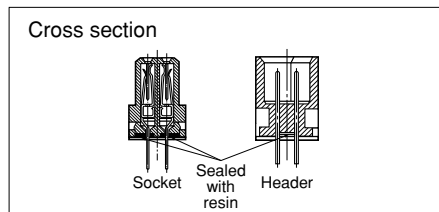



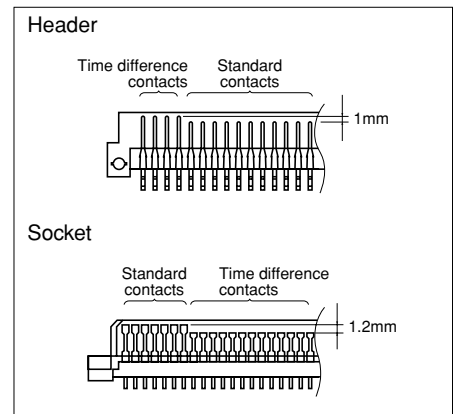

4) Time difference contacts

- ICs are protected from damage at connection even if the PC board is inserted or removed without power connected during maintenance or inspection. This simplifies circuit design.
- A contact time difference of 1mm for headers and 1.2mm for sockets is obtained.
- Time difference contacts can be arranged as desired.





DIN CONNECTORS (AXD)

PRODUCT TABLE

Type		Socket				Header			
		Standard types		Reverse types		Standard types		Reverse types	
		B type 2 rows	C type 3 rows	Q type 2 rows	R type 3 rows	B type 2 rows	C type 3 rows	Q type 2 rows	R type 3 rows
No. of contacts	100		100		100		100		
	96			96		96		96	
	90				90				
	64	64 (The middle row is removed)	64	64 (The middle row is removed)	64	64 (The middle row is removed)	64	64 (The middle row is removed)	
	50		50		50		50		
	44				44				
	32			32			32		
	20				20				
Terminal shape									
Higher functional products availability	PC board top mounting type	—	—	Available	Available	Available	Available	—	—
	Self-clinching bracket (temporary fastening)	Available	Available	Available	Available	Available	Available	Available	Available
	Flux-resistant construction	Available	Available	—	—	—	—	Available	Available
	Time difference contacts	Available	Available	—	—	Available	Available	Available	Available

PRODUCT TYPES (STANDARD)



1) B type (standard 2 rows)

No. of contacts	Shape	
	Socket 	Header 
	Solder-dip straight terminals	Solder-dip angle terminals
	Part No.	Part No.
20	AXD120201	AXD220211
32	AXD132201	AXD232211
44	AXD144201	AXD244211
50	AXD150201	AXD250211
64	AXD164201	AXD264211
90	AXD190201	AXD290211
100	AXD100201	AXD200211

Notes)

- All are tray packaged. Packing quantity for outer carton is 200 pcs.
- For the available foreign standard products, refer to "STANDARDS CHART" on the end of the catalog.



2) C type (standard 3 rows)

No. of contacts	Shape	
	Socket 	Header 
	Solder-dip straight terminals	Solder-dip angle terminals
	Part No.	Part No.
64 (The middle row is removed)	AXD164301	AXD264311
96	AXD196401	AXD296411

Notes)

- All are tray packaged. Packing quantity for outer carton is 200 pcs.
- For the available foreign standard products, refer to "STANDARDS CHART" on the end of the catalog.



3) Q type (reverse 2 rows)

No. of contacts	Shape	
	Socket 	Header 
	Solder-dip angle terminals	Solder-dip straight terminals
	Part No.	Part No.
32	AXD132811	AXD232801
50	AXD150811	AXD250801
64	AXD164811	AXD264801

Notes)

- All are tray packaged. Packing quantity for outer carton is 200 pcs.
- Adopting box shape, Q types differ from DIN international standards (open shape) on the mounting spacing.

4) R type (reverse 3 rows)

No. of contacts	Shape	
	Socket 	Header 
	Solder-dip angle terminals	Solder-dip straight terminals
	Part No.	Part No.
64 (The middle row is removed)	AXD164611	AXD264601
96	AXD196711	AXD296701

Note)

- All are tray packaged. Packing quantity for outer carton is 200 pcs.

DIN CONNECTORS (AXD)

PRODUCT TYPE (HIGHER FUNCTIONAL products)

1. Top mounting types

1) B type (standard 2 rows)

Shape	Header 	
	Solder-dip angle terminals	
No. of contacts	Part No.	
20	AXD220201	
32	AXD232201	
44	AXD244201	
50	AXD250201	
64	AXD264201	
90	AXD290201	
100	AXD200201	

2) C type (standard 3 rows)

Shape	Header 	
	Solder-dip angle terminals	
No. of contacts	Part No.	
64 (The middle row is removed)	AXD264301	
96	AXD296401	

3) Q type (reverse 2 rows)

Shape	Socket 	
	Solder-dip angle terminals	
No. of contacts	Part No.	
32	AXD132801	
50	AXD150801	
64	AXD164801	
100	AXD100801	

4) R type (reverse 3 rows)



Shape	Socket 	
	Solder-dip angle terminals	
No. of contacts	Part No.	
64 (The middle row is removed)	AXD164601	
96	AXD196701	

Notes)



1. All are tray packaged. Packing quantity for outer carton is 200 pcs.
2. For the available foreign standard products, refer to "STANDARDS CHART" on the end of the catalog.

2. Type with self-clinching bracket



1) B type (standard 2 rows)

Shape	Socket 	Header 
	(PC board top mounting type)	
No. of contacts	Solder-dip straight terminals Part No.	Solder-dip angle terminals Part No.
20	AXD120251	AXD220251
32	AXD132251	AXD232251
44	AXD144251	AXD244251
50	AXD150251	AXD250251
64	AXD164251	AXD264251
90	AXD190251	AXD290251
100	AXD100251	AXD200251



2) C type (standard 3 rows)

Shape	Socket 	Header 
	(PC board top mounting type)	
No. of contacts	Solder-dip straight terminals Part No.	Solder-dip angle terminals Part No.
64 (The middle row is removed)	AXD164351	AXD264351
96	AXD196451	AXD296451

3) Q type (reverse 2 rows)

Shape	Socket 	Header 
	(PC board top mounting type)	
No. of contacts	Solder-dip angle terminals Part No.	Solder-dip straight terminals Part No.
32	AXD132851	AXD232851
50	AXD150851	AXD250851
64	AXD164851	AXD264851
100	AXD100851	AXD200851

4) R type (reverse 3 rows)

Shape	Socket 	Header 
	(PC board top mounting type)	
No. of contacts	Solder-dip angle terminals Part No.	Solder-dip straight terminals Part No.
64 (The middle row is removed)	AXD164651	AXD264651
96	AXD196751	AXD296751

Notes)

1. All are tray packaged. Packing quantity for outer carton is 200 pcs.
2. For the available foreign standard products, refer to "STANDARDS CHART" on the end of the catalog.

DIN CONNECTORS (AXD)

3. Flux resistance types

1) B type (standard 2 rows)

No. of contacts	Shape	
	Socket 	
	Solder-dip straight terminals	
	Without self-clinching bracket	With self-clinching bracket
	Part No.	Part No.
20	AXD120221	AXD120271
32	AXD132221	AXD132271
44	AXD144221	AXD144271
50	AXD150221	AXD150271
64	AXD164221	AXD164271
90	AXD190221	AXD190271
100	AXD100221	AXD100271

2) C type (standard 3 rows)

No. of contacts	Shape	
	Socket 	
	Solder-dip straight terminals	
	Without self-clinching bracket	With self-clinching bracket
	Part No.	Part No.
64 (The middle row is removed)	AXD164321	AXD164371
96	AXD196421	AXD196471

3) Q type (reverse 2 rows)

No. of contacts	Shape	
	Header 	
	Solder-dip straight terminals	
	Without self-clinching bracket	With self-clinching bracket
	Part No.	Part No.
32	AXD232821	AXD232871
50	AXD250821	AXD250871
64	AXD264821	AXD264871
100	AXD200821	AXD200871

4) R type (reverse 3 rows)

No. of contacts	Shape	
	Header 	
	Solder-dip straight terminals	
	Without self-clinching bracket	With self-clinching bracket
	Part No.	Part No.
64 (The middle row is removed)	AXD264621	AXD264671
96	AXD296721	AXD296771

Notes)

1. All are tray packaged. Packing quantity for outer carton is 200 pcs.
2. For the available foreign standard products, refer to "STANDARDS CHART" on the end of the catalog.

4. Accessory

Name	Part No.	Packaging	
		Inner carton	Outer carton
Incorrect insertion prevention key	AXD8001	50 pcs.	200 pcs.

5. Time difference contacts

Time difference contacts can be arranged as desired. Please consult us.

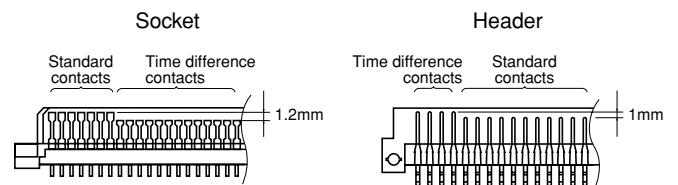

DIN CONNECTORS (AXD)

DIMENSIONS of 2 Rows type (mm)

General tolerance: ± 0.3

• B type socket (20, 32, 44, 50, 64, 90 and 100 contacts)

Solder-dip straight terminals

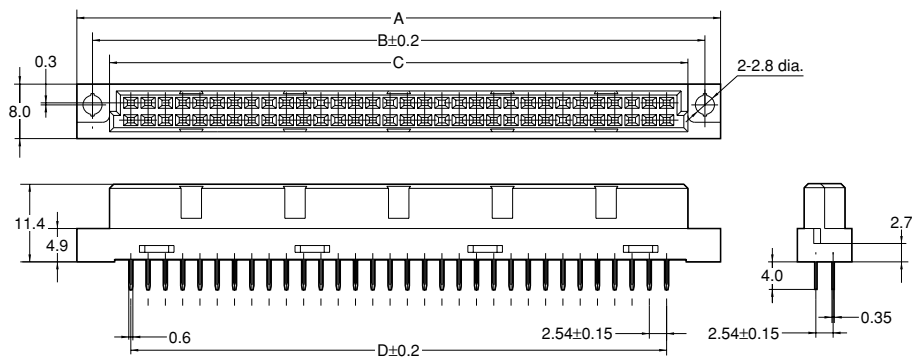
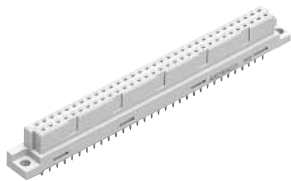

Dimension table (mm)

No. of contacts	A	B	C	D
20	38.72	34.12	29.12	22.86
32	53.96	49.36	44.36	38.1
44	69.2	64.6	59.6	53.34
50	76.82	72.22	67.22	60.96
64	94.6	90.0	85.0	78.74
90	127.62	123.02	118.02	111.76
100	140.32	135.72	130.72	124.46

Recommended PC board pattern (Bottom view)

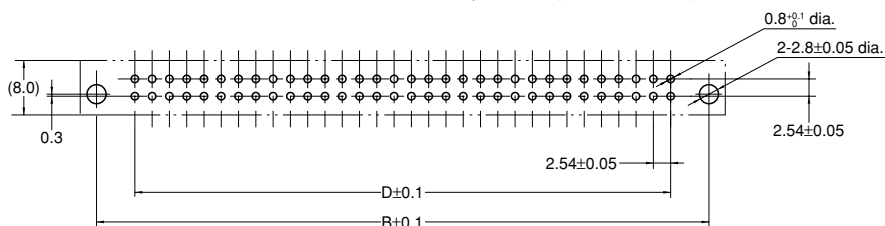

• B type header (20, 32, 44, 50, 64, 90 and 100 contacts)

Solder-dip angle terminals

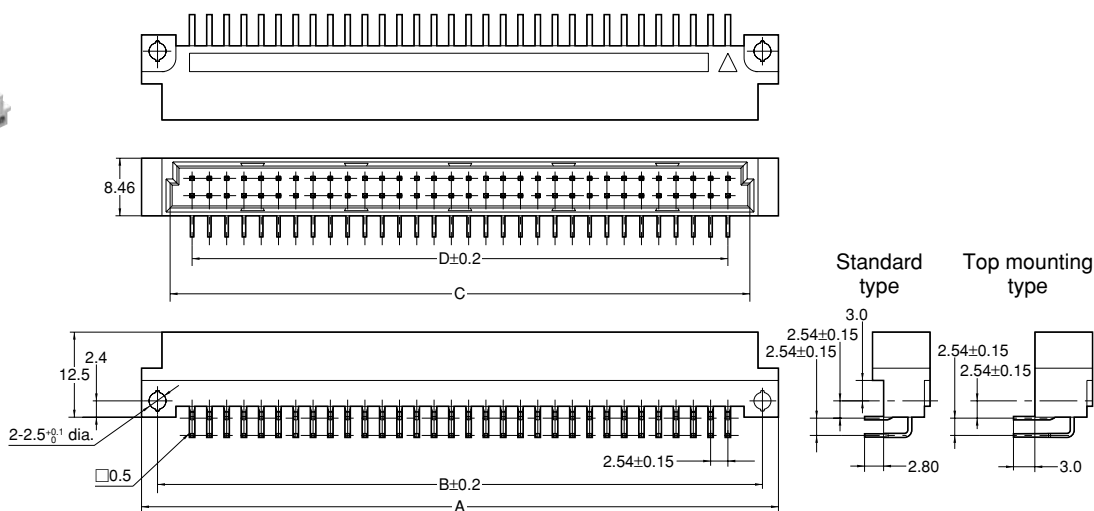
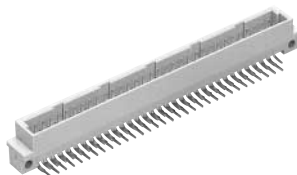

Recommended PC board pattern (Bottom view)

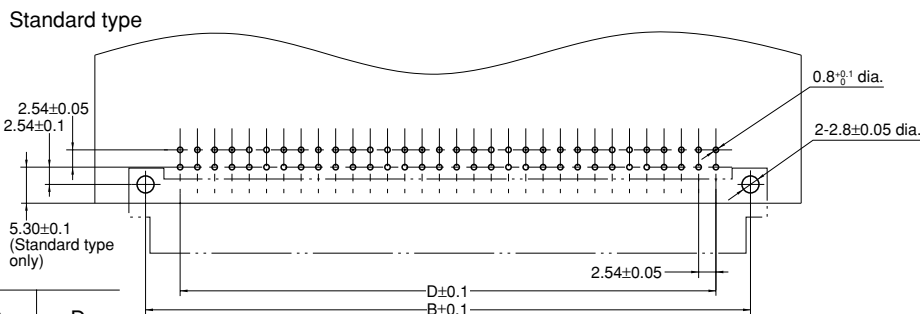

Dimension table (mm)

No. of contacts	A	B	C	D
20	37.72	33.02	29.32	22.86
32	52.96	48.26	44.56	38.1
44	68.2	63.5	59.8	53.34
50	75.82	71.12	67.42	60.96
64	93.6	88.9	85.2	78.74
90	126.62	121.92	118.22	111.76
100	139.32	134.62	130.92	124.46

DIN CONNECTORS (AXD)

• Q type socket (32, 50, 64 and 100 contacts)

General tolerance: ± 0.3

Solder-dip angle terminals

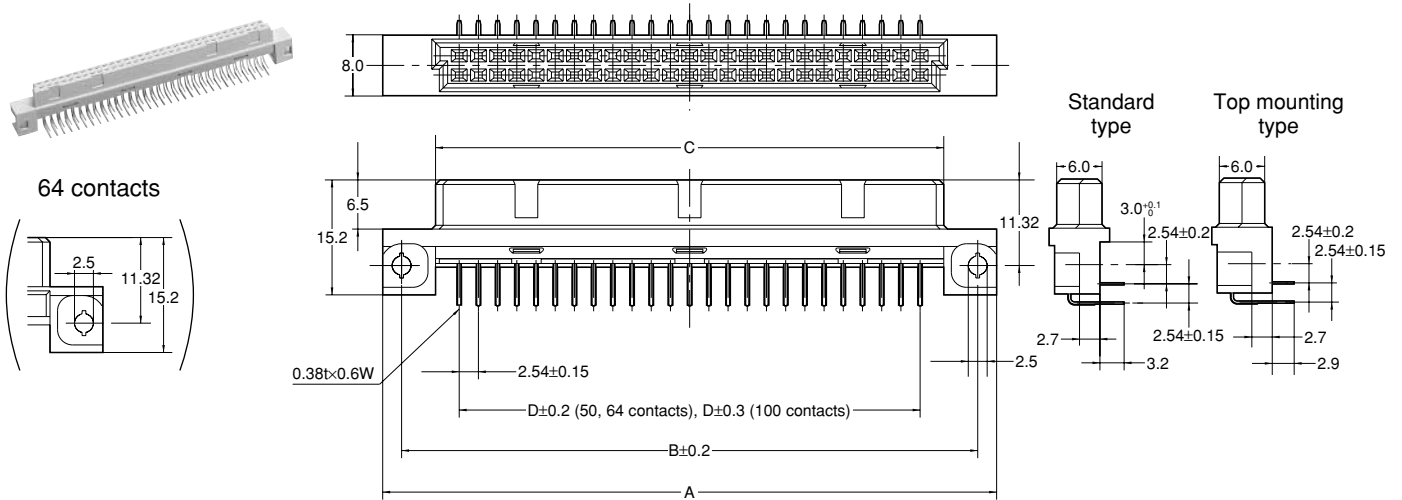

Recommended PC board pattern (Bottom view)

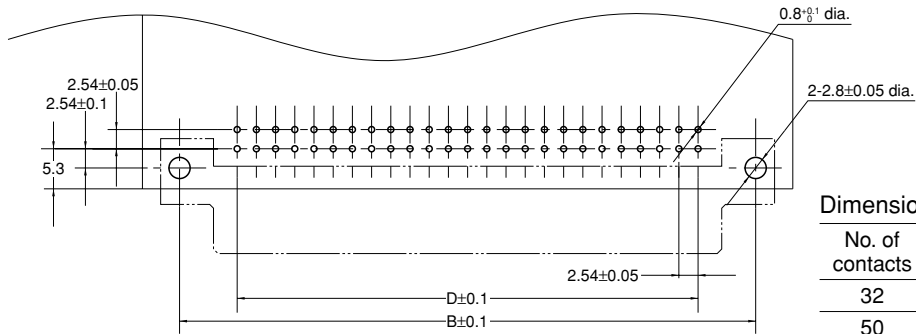

Dimension table (mm)

No. of contacts	A	B	C	D
32	58.34	53.34	44.36	38.1
50	81.2	76.2	67.22	60.96
64	98.98	93.98	85.0	78.74
100	144.9	139.7	130.72	124.46

• Q type header (32, 50, 64 and 100 contacts)

Solder-dip straight terminals

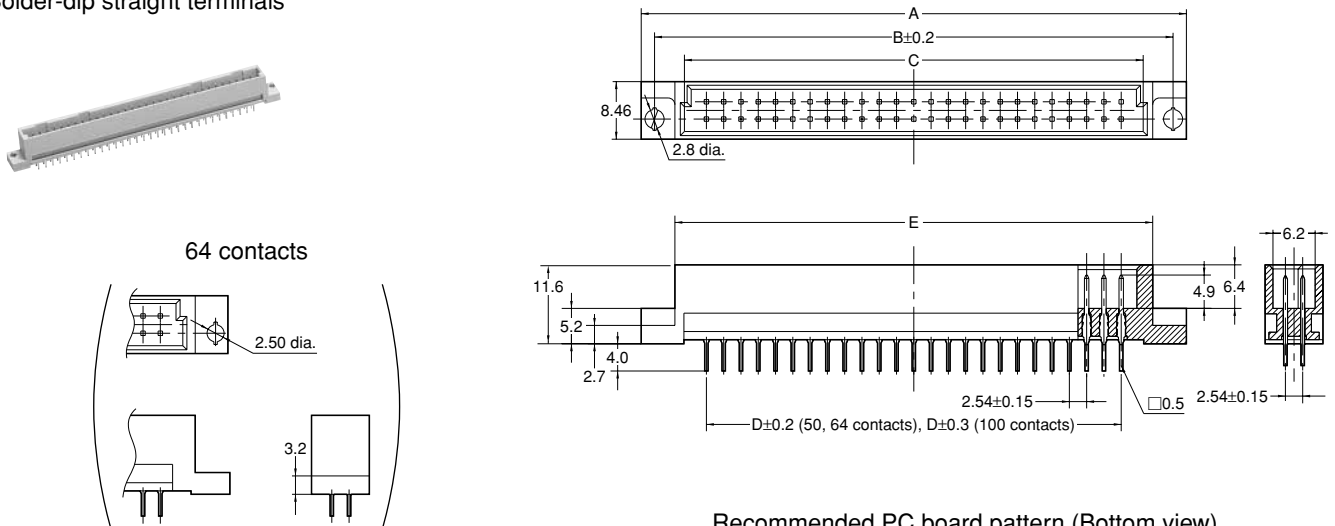

Recommended PC board pattern (Bottom view)

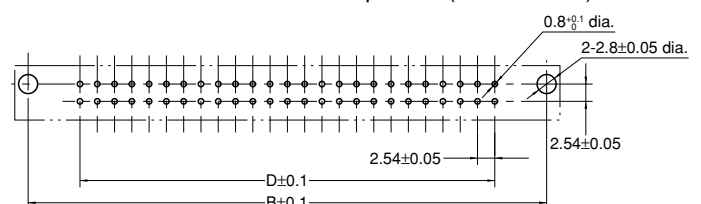

Dimension table (mm)

No. of contacts	A	B	C	D	E
32	57.26	53.34	44.56	38.1	47.36
50	80.12	76.2	67.42	60.96	70.22
64	97.6	93.98	85.35	78.74	87.87
100	143.62	139.7	130.92	124.46	133.72

DIN CONNECTORS (AXD)

DIMENSIONS of 3 Rows type (mm)

General tolerance: ± 0.3

• C type socket (64 and 96 contacts)

Solder-dip straight terminals

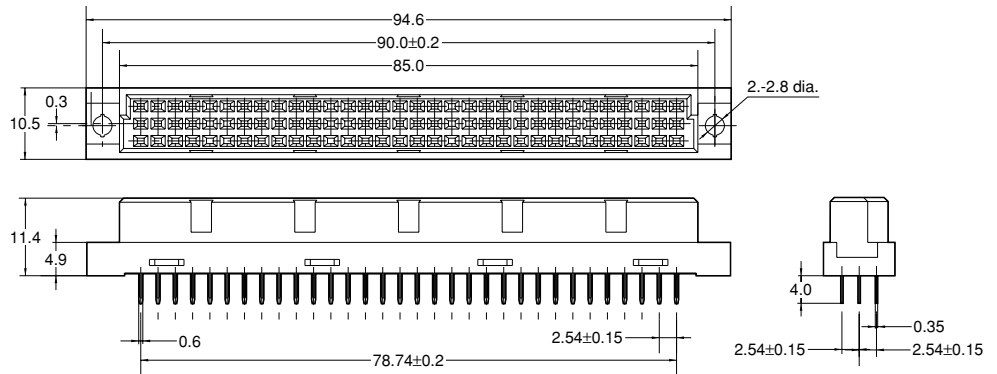
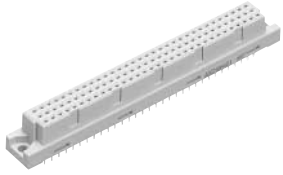

Recommended PC board pattern (Bottom view)

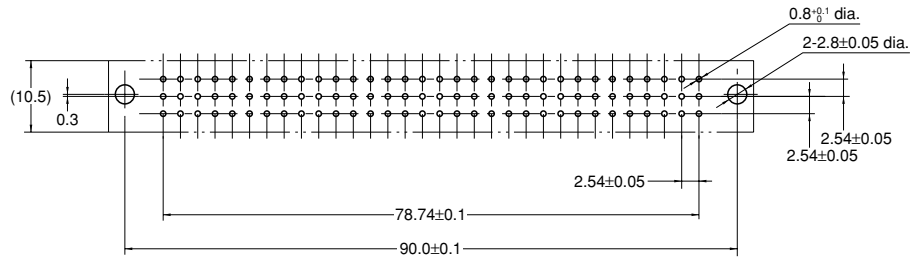

Note: For 64 contacts type,
the middle row is removed.

• C type header (64 and 96 contacts)

Solder-dip angle terminals

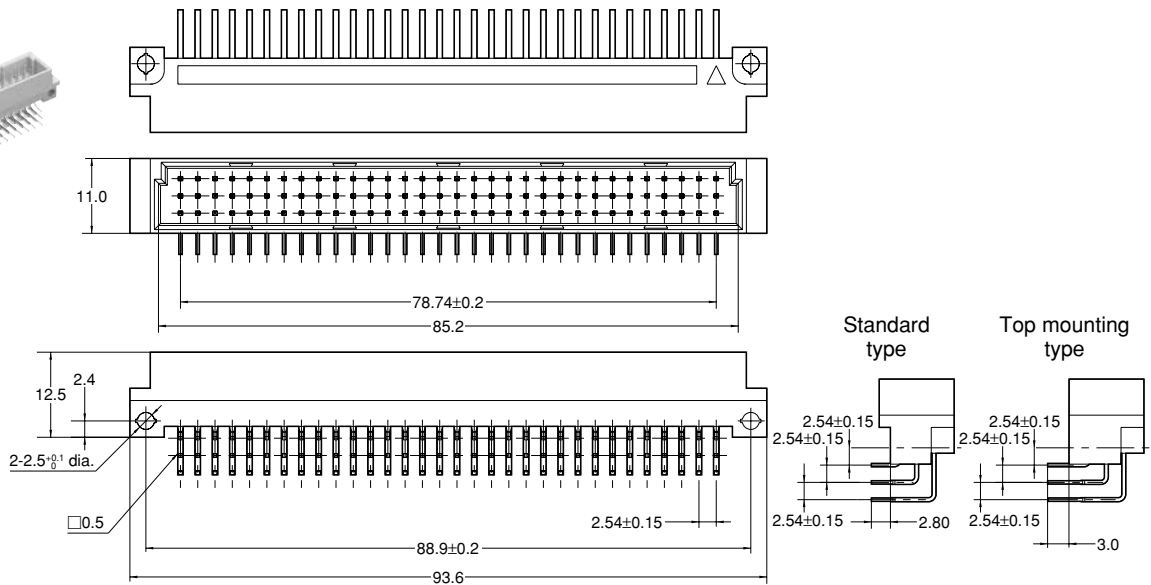
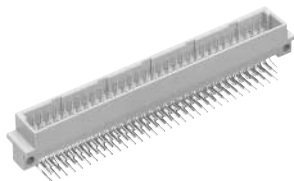

Recommended PC board pattern (Bottom view)

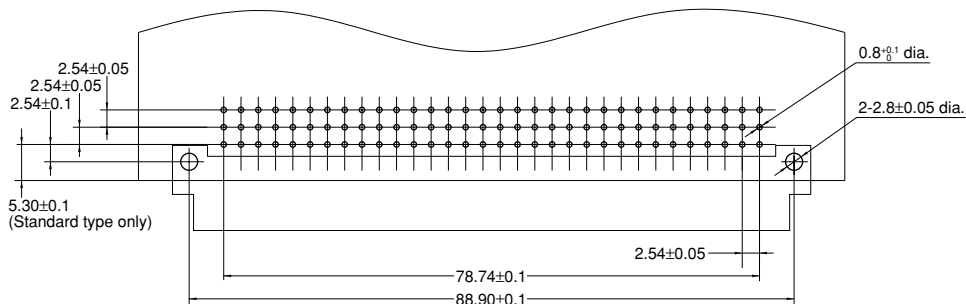

Note: For 64 contacts type,
the middle row is removed.

DIN CONNECTORS (AXD)

• R type socket (64 and 96 contacts)

General tolerance: ± 0.3

Solder-dip angle terminals

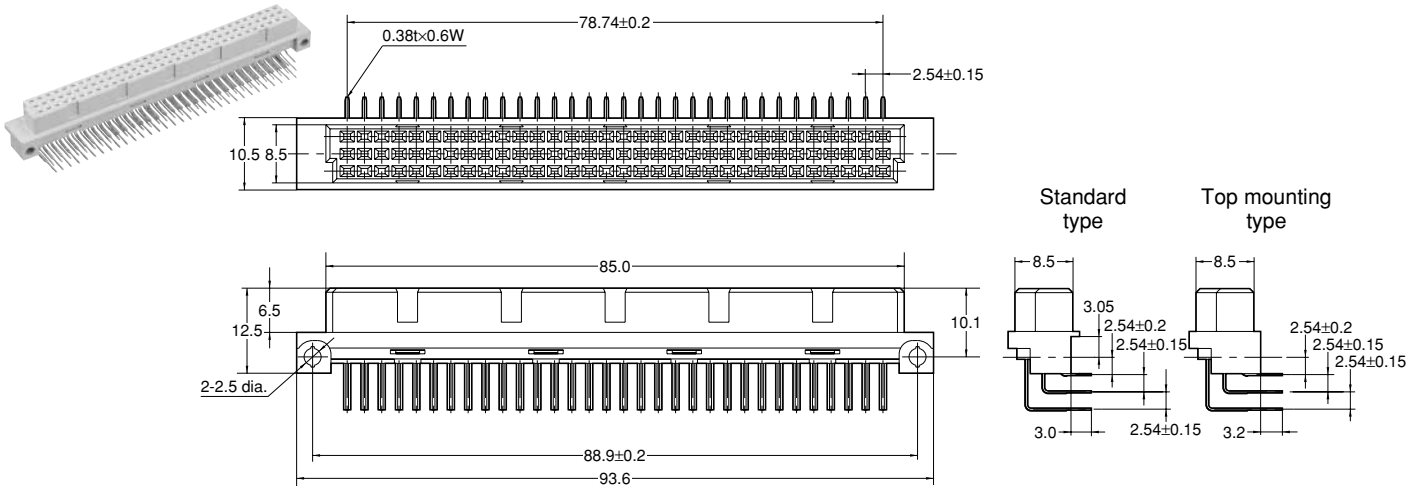

Recommended PC board pattern (Bottom view)

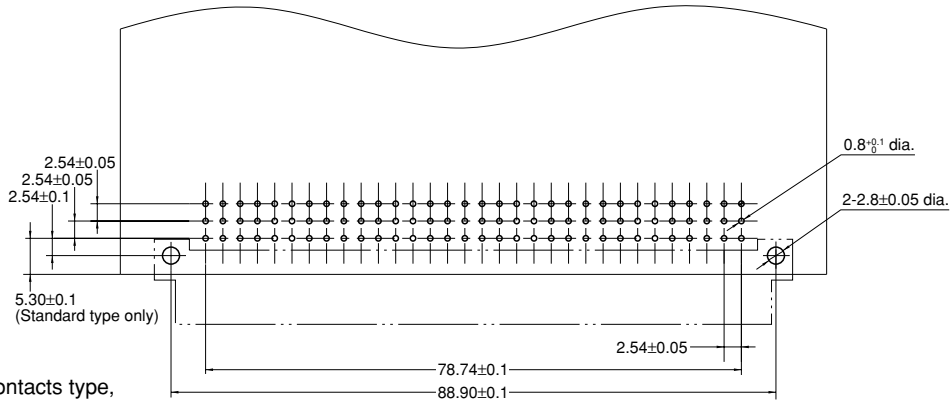

Note: For 64 contacts type, the middle row is removed.

• R type header (64 and 96 contacts)

Solder-dip straight terminals

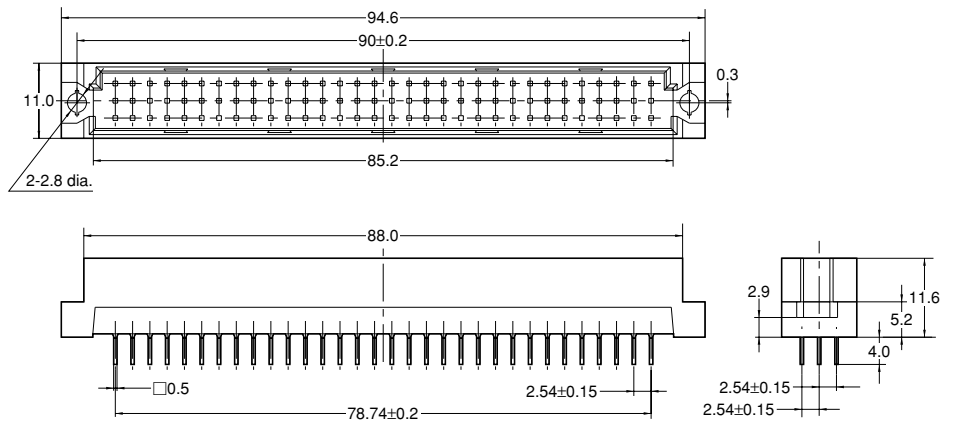
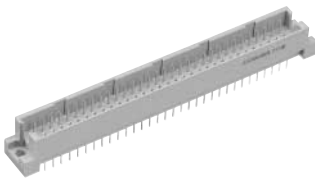

Recommended PC board pattern (Bottom view)

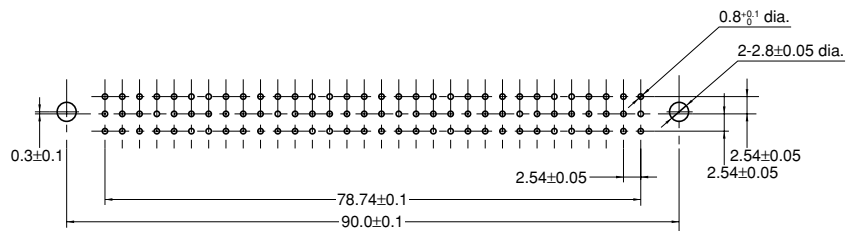

Note: For 64 contacts type, the middle row is removed.

Self-clinching bracket type (mm)

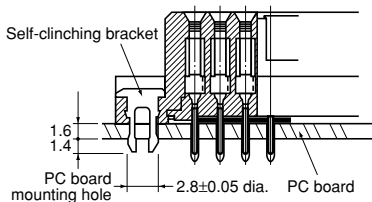

DIN CONNECTORS (AXD)

COMBINATION FORM (mm)

Types	Header	Vertical fixing		Stacking fixing	Horizontal fixing
		Standard	Reverse		
2 rows type	PC board edge mounting type (DIN standards)				
	PC board top mounting type				
3 rows type	PC board edge mounting type (DIN standards)				
	PC board top mounting type				

NOTES

1. Regarding printed circuit board design

As the terminal numbers are marked on the connector, the printed circuit board design can be carried out based on the terminal numbers.

2. Regarding soldering for header and socket

Soldering should be carried out under the following conditions.

260°C: within 10 seconds

300°C: within 5 seconds

350°C: within 3 seconds

The automatic soldering operation should be carried out for the header after masking tape is applied as shown below.

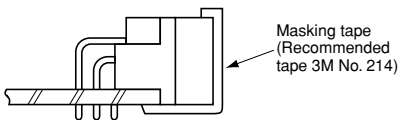

3. Regarding handling of header and socket terminals

Repeated bending of the terminals can cause breakage. Care should be taken.

4. Insertion and removal of socket and header should be carried out with the following procedure.

a) Insertion

• After checking to be sure the polarity of socket and header are correct, the header side is inserted following the guide, gently combining with the top of the socket.

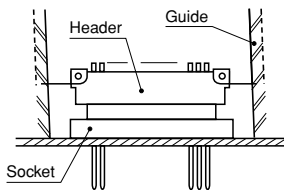

• Uniformly push the upper edge of the printed circuit board of the header side so that the header enters the socket until it butts against the socket flange.

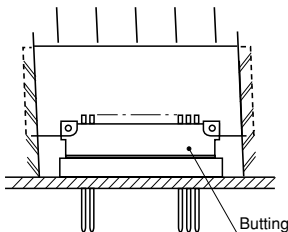

b) Removal

• Apply uniform force with the lever and carry out the separation.

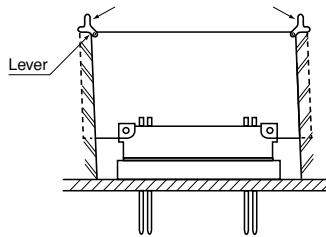

5. Determination of the position of the header and socket should be done as shown in the following drawings.

a) Tilt

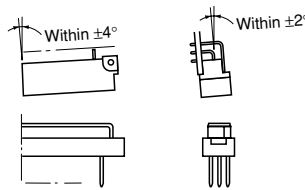

b) Offset

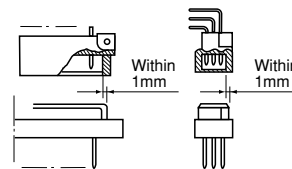

6. For multiple use of connectors on identical boards, sufficient care must be taken with the mounting dimensions and the strength of the socket side (board and holder).

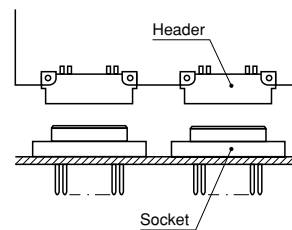

7. By using max. 34.3N {3.5kgf} torque, tighten the screws with flat washer.

8. Method for preventing incorrect insertion

1) After the incorrect insertion prevention key is inserted in the designated groove position, the handle portion should be broken away.

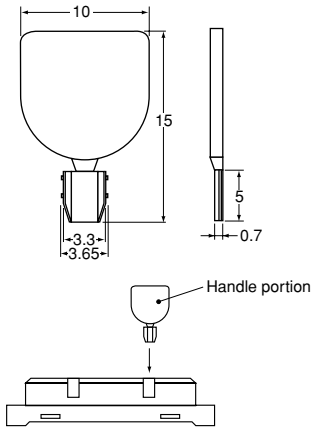

2) When DIN connectors with the identical number of contacts are used, for preventing incorrect insertion between boards, use the following example as a reference for the incorrect insertion prevention keys.

Example:

Incorrect insertion is to be prevented for the 3 connectors A, B, and C.

1 to 5: Key way position

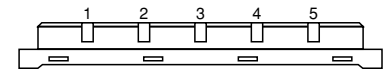

Header			Key way positions	Socket		
C	B	A		A	B	C
*		*	1		*	
	*		2	*		*
		*	3			*
*			4	*		
			5			

*: Locations for inserting the incorrect insertion preventing key

9. In case where external shock or vibration can be applied to PC boards, there is the possibility that the header and socket of the connector can be separated. Therefore it is recommended that the shock or vibration prevention method such as guide rail should be provided.

Regarding general notes, please refer to page 12.

For other details, please verify with the product specification sheets.