



The Future of Analog IC Technology®

# MP26053

## 28V, 1A Li-Ion/Li-Polymer Battery Charger With 10% Battery-Full Threshold, Trickle Charge and Timer

### DESCRIPTION

The MP26053 is a linear, high-performance single cell Li-Ion/Li-Polymer battery charger. By integrating high voltage input protection into the charger IC, the MP26053 can tolerate an input surge up to +28V. In addition, the MP26053 features an internally programmed precision battery full-threshold of 10% of  $I_{CHG}$ .

The device features constant current (CC) and constant voltage (CV) charging modes with programmable charge currents (200mA to 1A), current blocking, and trickle charge. The device also provides fault and charge status indications to the system.

For guaranteed safe operation, the MP26053 reduces charge current when the device reaches high temperature (due to limited PCB space). Other safety features include battery temperature monitoring and programmable timer to complete the charging cycle.

The MP26053 is available in 10-pin 3mm x 3mm QFN packages.

### FEATURES

- Proprietary  $V_{IN}$  Surge Protection up to 28V
- 10% Battery-Full Threshold
- Programmable Charge Current : 200mA to 1.0A
- Trickle Charge
- 40 $\mu$ A Shutdown Current
- 7V Input OVP
- Auto Recharge
- Charge-Timer
- Fault and Charge Status Indicators

### APPLICATIONS

- Cell Phones
- Digital Cameras
- Smart Phones
- PDAs
- MP3 Players

"MPS" and "The Future of Analog IC Technology" are Registered Trademarks of Monolithic Power Systems, Inc.

### TYPICAL APPLICATION

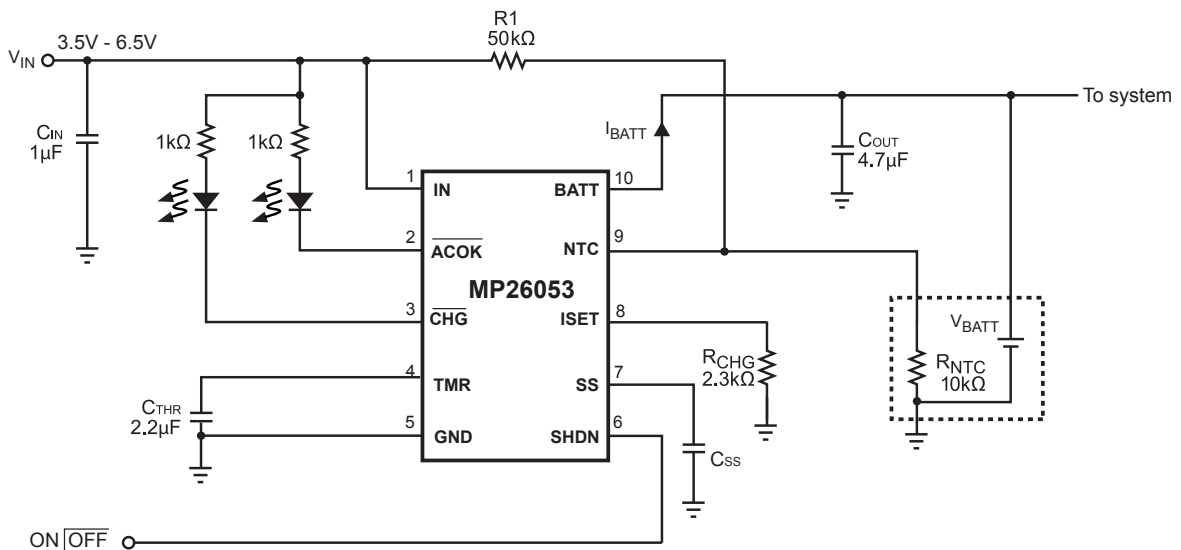

**PACKAGE REFERENCE**

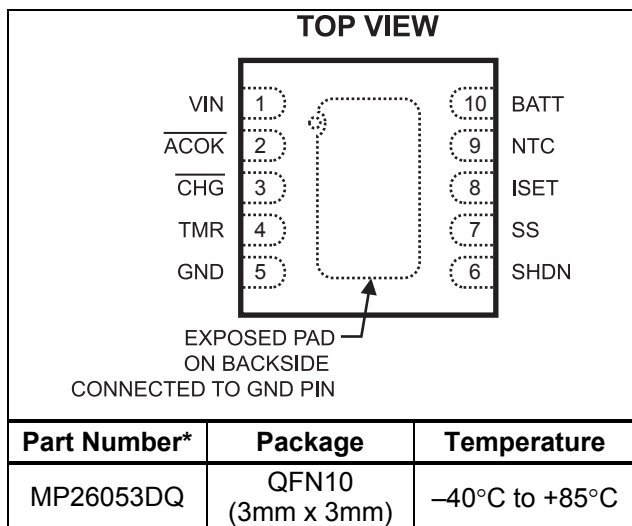

\* For Tape & Reel, add suffix -Z (e.g. MP26053DQ-Z)  
 For RoHS compliant packaging, add suffix -LF  
 (e.g. MP26053DQ-LF-Z)

**ABSOLUTE MAXIMUM RATINGS <sup>(1)</sup>**

IN to GND ..... -0.3V to +28V  
 ACOK and CHG Maximum Sink Current.....20mA  
 All Other Pins to GND.....-0.3V to +6.5V  
 Junction Temperature..... 140°C  
 Lead Temperature .....260°C  
 Storage Temperature .....-65°C to +150°C

**Recommended Operating Conditions <sup>(2)</sup>**

Nominal Supply Voltage  $V_{IN}$ ..... 3.5V to 6.5V  
 Operating Temperature .....-40°C to +85°C

**Thermal Resistance <sup>(3)</sup>**  $\theta_{JA}$   $\theta_{JC}$   
 3x3 QFN10 ..... 50..... 12... °C/W

**Notes:**

- 1) Exceeding these ratings may damage the device.
- 2) The device is not guaranteed to function outside of its operating conditions.
- 3) Measured on approximately 1" square of 1 oz copper. The exposed pad must be Soldered to a ground plane

**ELECTRICAL CHARACTERISTICS**

$V_{IN} = 5V$ ,  $V_{SHDN} = 0V$ ,  $T_A = +25^\circ C$ , unless otherwise noted.

| Parameter   | Symbol       | Condition  | Min  | Typ  | Max  | Units             |
|---|--------------|--|------|------|------|-------------------|
| Supply Current  | $I_{SUPPLY}$ | SHDN = High  |      | 40   |      | $\mu A$           |
|   |              | SHDN= Low, $I_{CHG} = 0A$ ,<br>$V_{BATT}=4.1V$   |      | 200  |      | $\mu A$           |
| Battery Voltage Regulation                                | $V_{BATT}$   | $T = -5^\circ C$ to $+75^\circ C$ , $I_{BATT} = 0$   | 4.16 | 4.20 | 4.24 | V                 |
| Constant Current Regulation                               | $I_{CHG}$    | $V_{IN} = 5V$ , $V_{BATT} = 3.8V$<br>$R_{CHG} = 3.3k\Omega$  | 448  | 515  | 582  | mA                |
| Constant Current Variation                                |              | $V_{IN} = 5V$ , $V_{BATT} = 3.8V$ ,<br>$T_J = 0^\circ C$ to $+120^\circ C$ ,<br>$R_{CHG} = 1.6k\Omega$ to $8.0k\Omega$ | 87   | 100  | 113  | $\%I_{CHG}^{(4)}$ |
| End of Charge Threshold                                   | $I_{BF}$     |  | 7.5  | 10   | 12.5 | $\%I_{CHG}^{(4)}$ |
| Trickle Current   |              | $V_{IN} = 5V$ , $V_{BATT} = 2.3V$  | 5    | 10   | 15   | $\%I_{CHG}^{(4)}$ |
| Trickle Threshold Voltage                                 |              |  | 2.45 | 2.6  | 2.75 | V                 |
| Trickle Voltage Hysteresis                                |              |  |      | 100  |      | mV                |
| Input $\overline{ACOK}$ Up Range                          |              |  | 6.7  | 7    | 7.3  | V                 |
| Input $\overline{ACOK}$ Low Range                         |              |  | 1.5  | 2    | 2.5  | V                 |
| $\overline{ACOK}$ and $\overline{CHG}$ Over-voltage Clamp | $V_Z$        |  |      | 8.2  |      | V                 |
| Input Over Voltage Protection                             | OVP          | $V_{IN}$ Rising  | 6.7  | 7    | 7.3  | V                 |
| OVP Hysteresis  |              |  |      | 400  |      | mV                |

**ELECTRICAL CHARACTERISTICS** *(continued)*

$V_{IN} = 5V$ ,  $V_{SHDN} = 0V$ ,  $T_A = +25^{\circ}C$ , unless otherwise noted.

| Parameter   | Symbol            | Condition   | Min  | Typ  | Max  | Units       |
|---|-------------------|---|------|------|------|-------------|
| SHDN Trip Threshold High                          |                   |   | 2.6  |      |      | V           |
| SHDN Trip Threshold Low                           |                   |   |      |      | 0.4  | V           |
| SHDN Pull up Current                              | $I_{SHDN}$        | $V_{SHDN}=3V$   |      | 6    |      | $\mu A$     |
| $\overline{CHG}$ , $\overline{ACOK}$ Sink Current |                   | Pin Voltage = 0.4V  | 8    |      |      | mA          |
| Battery Reverse Current to BATT Pin               |                   | SHDN = Low and Input = Floating or 0V                       |      |      | 1    | $\mu A$     |
| $V_{IN}$ Reverse Current                          |                   | Ground current at $V_{in}=-6V$                              |      | 10   |      | mA          |
| Dropout Voltage                                   | $V_{IN}-V_{BATT}$ | $V_{BATT} = 3.8V$ , $R_{CHG} = 6k\Omega$ . Current drop 10% |      | 0.25 |      | V           |
| Die Temperature Limit                             |                   |   | 105  | 120  | 135  | $^{\circ}C$ |
| Recharge Voltage Threshold                        | $V_{RECHARGE}$    |   | 3.9  | 4.0  | 4.1  | V           |
| Recharge Voltage Hysteresis                       |                   |   |      | 100  |      | mV          |
| NTC Upper Threshold                               | $V_{NTC\_UP}$     | $V_{IN}=5.00V$ , NTC pin voltage rising                     | 1.71 | 1.76 | 1.81 | V           |
| NTC Upper Trip Hysteresis                         |                   |   |      | 75   |      | mV          |
| NTC Lower Threshold                               | $V_{NTC\_LOW}$    | $V_{IN}=5.00V$ , NTC pin voltage falling                    | 0.35 | 0.38 | 0.41 | V           |
| NTC Lower Trip Hysteresis                         |                   |   |      | 20   |      | mV          |
| Oscillation Freq                                  |                   | $C_{TMR} = 2.2\mu F$  |      | 5    |      | Hz          |
| TMR Pin Source Current                            | $I_{TMR1}$        | $V_{TMR}=0.1V$  |      | 20   |      | $\mu A$     |
| TMR Pin Sink Current                              | $I_{TMR2}$        | $V_{TMR}=1.5V$  |      | 20   |      | $\mu A$     |
| Soft Start Time                                   |                   | From Trickle to 90% Full Current, $C_{SS}=0.1\mu F$         |      | 80   |      | mS          |

**Notes:**

4)  $I_{CHG}$  is the target preprogrammed charge current (Die temperature below 110 $^{\circ}C$ ).

## PIN FUNCTIONS

| Pin # | Name             | Description   |
|-------|------------------|---|
| 1     | VIN              | Input Supply Pin. VIN receives the AC adapter or USB supply voltage.  |
| 2     | ACOK             | Open-Drain Fault Status Indicator. This pin is high under any fault conditions.   |
| 3     | CHG              | Open-Drain Charge Indicator. This pin is low during charging, is high after battery full or termination, and is toggling when the battery is in fault condition.  |
| 4     | TMR              | Oscillator Period Timer. Connect a timing capacitor between this pin and GND to set the oscillator period. The total charge time: $T_{(SEC)} = 22 \times 10^3 * C_{TMR}$ , where $C_{TMR}$ is in $\mu F$ .  |
| 5     | GND, Exposed Pad | The exposed pad and GND pin must be connected to the same ground plane.   |
| 6     | SHDN             | Charger IC Enable. An input "Low" signal at this pin or pin floating will enable the IC.  |
| 7     | SS               | Soft-Start. Connect a capacitor to ground to set the soft-start time.   |
| 8     | ISET             | Constant Charge Current Program Pin. Connect this pin to an external resistor to program the charging current in CC Mode.   |
| 9     | NTC              | Negative Temperature Coefficient (NTC) Thermistor Pin. Connect a 50k $\Omega$ resistor from this pin to the VIN pin and a 10k $\Omega$ NTC resistor (within the battery pack) from this pin to ground. If NTC function is not used, replace NTC resistor with a regular 10k $\Omega$ resistor from this pin to ground. <b>Do not leave this pin floating.</b> |
| 10    | BATT             | Charger Output.   |

## BLOCK DIAGRAM

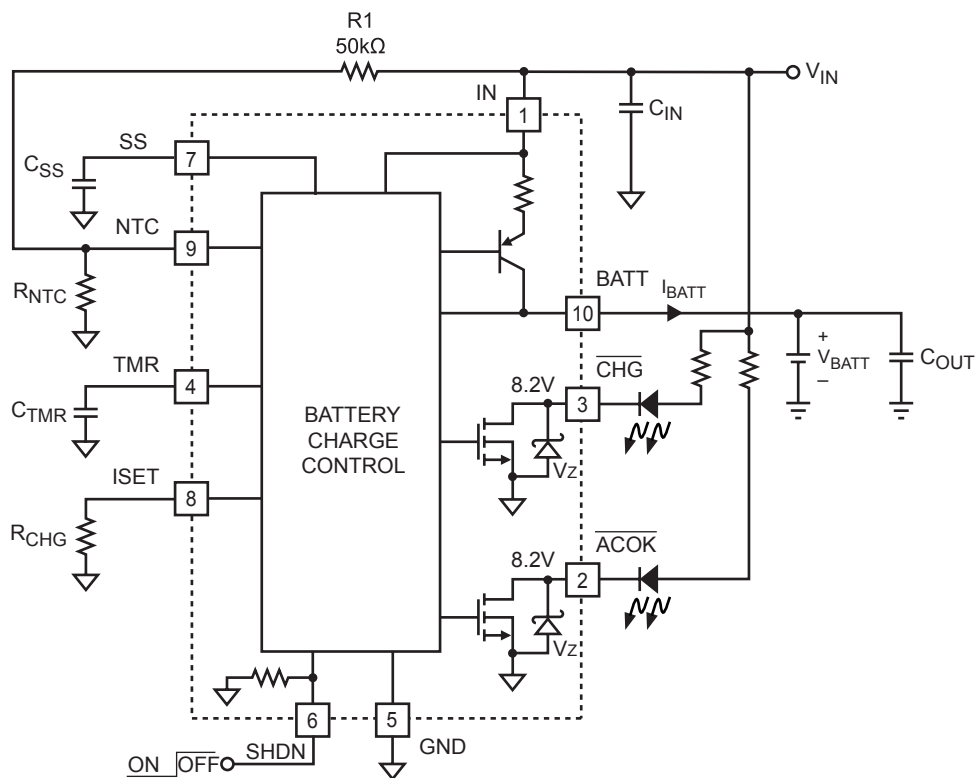
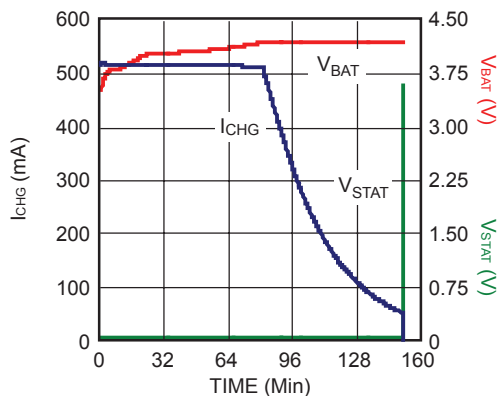

**Figure 1—Functional Block Diagram**

## TYPICAL PERFORMANCE CURVES

$C_{IN} = 4.7\mu F$ ,  $C_{OUT} = 2.2\mu F$ ,  $C_{SS} = 0.1\mu F$ ,  $V_{IN} = 5V$ ,  $T_A = +25^\circ C$ , unless otherwise noted.

**Battery Charge Curve**



**Charge Current vs Battery Voltage**

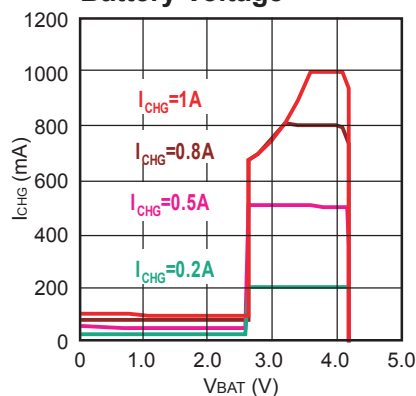

**Charge Current vs Battery Voltage**

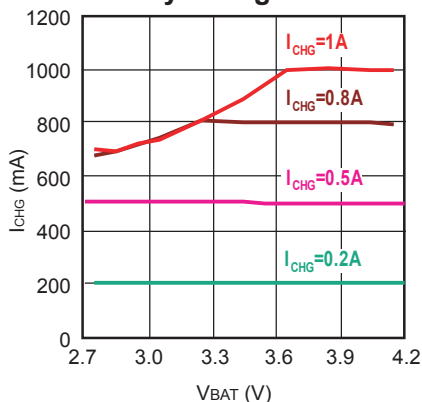

**$I_{CHG}$  Current vs Input Voltage**

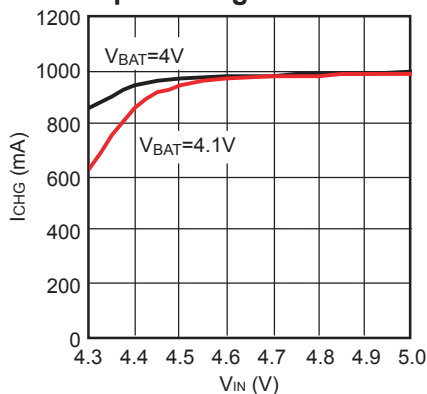

**$1/R_{SET}$  vs.  $I_{SET}$**

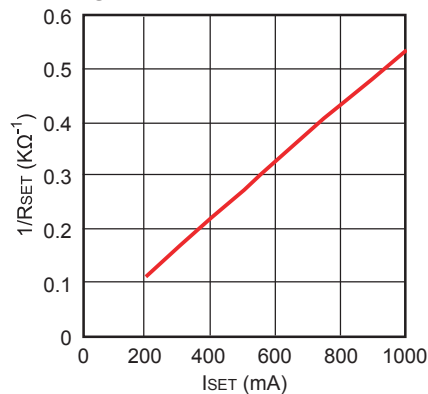

**Shut Down Low**

$V_{IN} = 5V$ ,  $I_{SET}$  Resistor = 2.26K

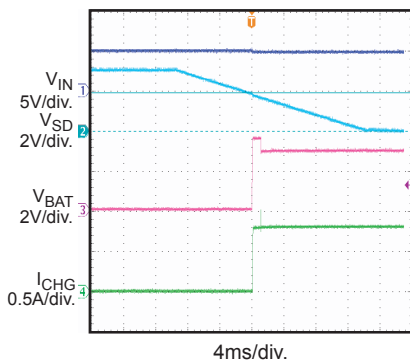

**Shut Down High**

$V_{IN} = 5V$ ,  $I_{SET}$  Resistor = 2.26K  
 $V_{BAT} = 3.8V$

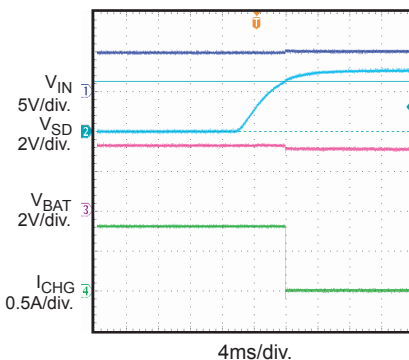

**Power Ramp Up vs. Battery Charge**

$V_{IN} = 5V$ ,  $I_{SET}$  Resistor = 2.3K

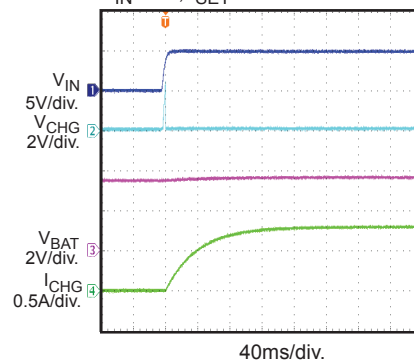

**TYPICAL PERFORMANCE CURVES (continued)**

$C_{IN} = 4.7\mu F$ ,  $C_{OUT} = 2.2\mu F$ ,  $C_{SS} = 0.1\mu F$ ,  $V_{IN} = 5V$ ,  $T_A = +25^\circ C$ , unless otherwise noted.

**Power Rump Down vs. Battery Charge**

$V_{IN} = 5V$ ,  $I_{SET}$  Resistor = 2.3K

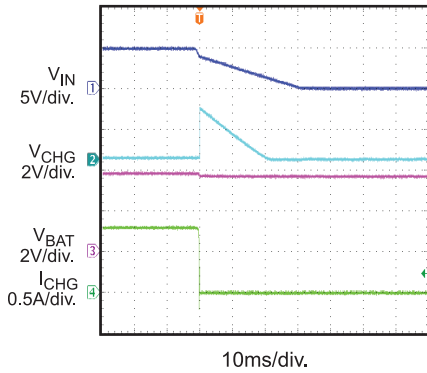

**Charge Full Terminated**

$V_{IN} = 5V$ ,  $I_{CHG} = 0.5A$

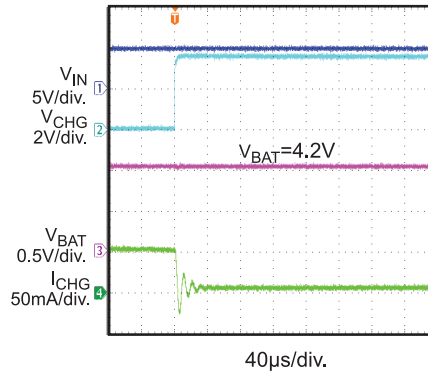

**Terminated to Re-Charge**

$V_{IN} = 5V$ ,  $I_{CHG} = 0.5A$

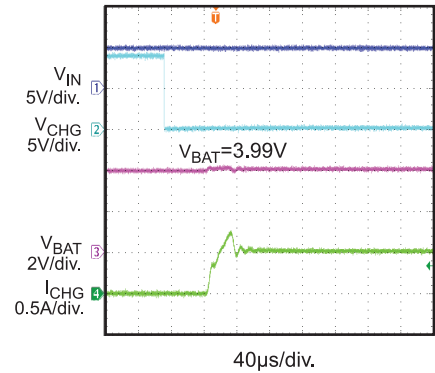

**NTC Window**

$V_{IN} = 5V$ ,  $I_{CHG} = 0.8A$

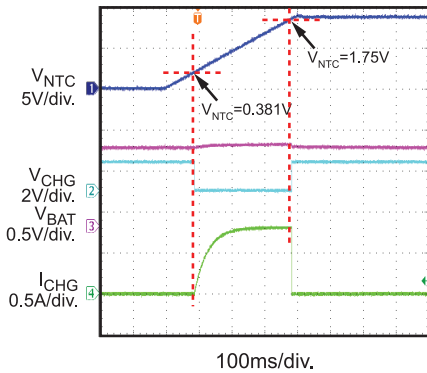

**ACOK and CHG Internal Zenor Diode Characteristics**

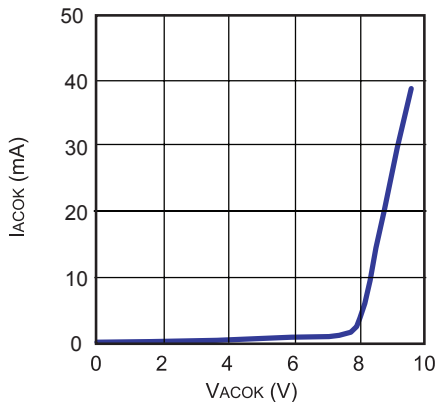

**Voltage Charge vs. Temperature**

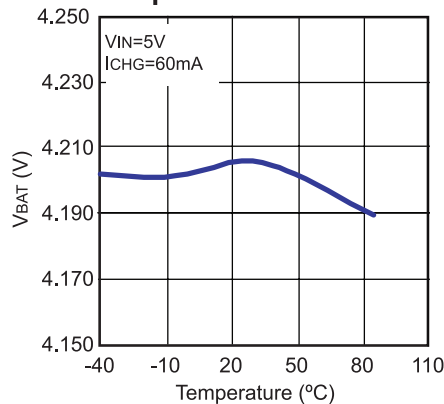

**Current Charge vs. Temperature**

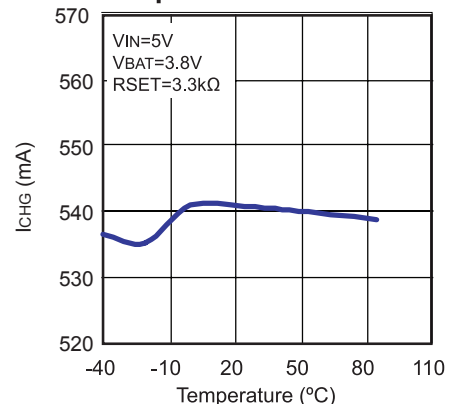

## OPERATION

### Input Voltage Range

The MP26053 has built-in input voltage surge protection as high as +28V. The charger IC will be automatically disabled when the input voltage is lower than 3.0V or higher than 7.0V. The open-drain pin  $\overline{ACOK}$  is used to indicate an input power good condition (i.e.  $3.0V < V_{IN} < 7.0V$ ). If the input voltage is lower than the battery voltage, the IC is also disabled to prevent the battery from draining.

### Charge Cycle (Mode Change: Trickle -> CC-> CV)

Figure 2 shows the typical charging profile for the MP26053. For a fully depleted battery with a terminal voltage lower than 2.6V, the MP26053 will start with the trickle charge (preconditioning) at 10% of the full charge current based on the value of  $R_{CHG}$ . If the charger stays in trickle mode longer than 32768 cycles,  $\overline{CHG}$  becomes high impedance, indicating a battery fault. After the battery voltage reaches 2.6V, the charger begins charging using the programmed charge current ( $I_{CHG}$ ). This is referred to as Constant Current (CC) mode. Once the battery voltage reaches 4.2V, the charger will operate in the constant voltage (CV) mode until the battery is fully charged. The charge current drops during CV mode, and the battery full indication is set when the charge current is reduced to 10% of the programmed constant current value ( $I_{CHG}$ ). The charge process is then terminated. Recharge will start after the battery voltage is reduced to 4.0V. After 262144 cycles of continuous charging, if the battery still has not reached 10% of the  $I_{CHG}$  condition, the on-chip timer will terminate the charger to prevent charging the dead battery excessively and the fault condition will be flagged by flashing the  $\overline{CHG}$  LED.

### Charge Termination

The charge current will gradually decrease in CV mode as the battery approaches full. The

battery full threshold is internally programmed to be 10% of the  $I_{CHG}$ . When the charge current reaches this threshold, the charger IC will be automatically turned off.

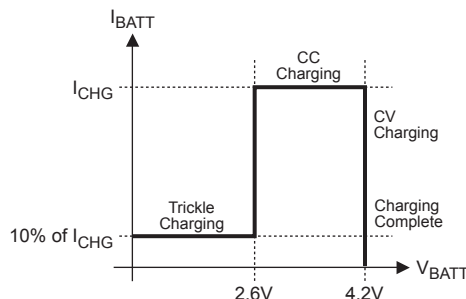

**Figure 2—MP26053 Typical Charging Profile**

### Automatic Recharge

When  $V_{BATT}$  drops to 4.0V, the charger will automatically restart the charge cycle until the 10%  $I_{CHG}$  condition is met again. When the input adapter is unplugged, or the charger is disabled and/or terminated, the leakage current from the battery to the MP26053 is less than 1uA.

### Programming of Charge Current and Battery Full Current

The charge current ( $I_{CHG}$ ) is set by a resistor ( $R_{CHG}$ ) connected from the ISET pin to GND. The relationship between the charge current and the programming resistance is established by the following table and graph.

**Table 1— $R_{CHG}$  and  $I_{CHG}$  Relationship**

| $R_{CHG}$ (k $\Omega$ ) | $I_{CHG}$ (mA) |
|-------------------------|----------------|
| 1.65                    | 1000           |
| 1.82                    | 900            |
| 2.05                    | 800            |
| 2.32                    | 700            |
| 2.74                    | 600            |
| 3.3                     | 500            |
| 4.12                    | 400            |
| 5.6                     | 300            |
| 8.45                    | 200            |
| 15                      | 100            |

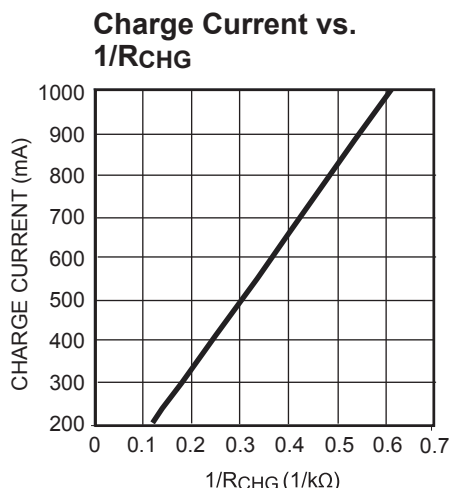

**Figure 3—Charge Current vs. 1/R<sub>CHG</sub> Resistance**

The recommended resistance for programming the charge current is  $2.3k\Omega < R_{CHG} < 11k\Omega$ . The open-drain pin  $\overline{CHG}$  is used to indicate charging status. When the battery full condition is met or any other condition prevents the charger from charging,  $\overline{CHG}$  will become a floating pin.

**Charger Status Indication**

|                  | SHDN = High Vin Fault | Battery Full | Time out Fault | Ambient Temperature Fault | In Charging |
|------------------|-----------------------|--------------|----------------|---------------------------|-------------|
| $\overline{CHG}$ | HIGH                  | HIGH         | Toggle         | HIGH                      | LOW         |

$\overline{ACOK}$  is LOW while  $3.0V < V_{IN} < 7V$ , otherwise it is HIGH.

**Negative Thermal Coefficient (NTC) Thermistor**

The MP26053 has a built-in NTC resistance window comparator. If configured as the typical application circuit as indicated in Figure 1, the MP26053 will cease charging if  $R_{NTC} < 4.161k\Omega$  or  $R_{NTC} > 27.285k\Omega$ . This represents a valid charging temperature range of 0°C to 50°C for the EWTF03-103 J31 H NTC resistor.

**Timer Operation**

The TMR pin is used to set the internal oscillator frequency,  $F_{OSC} = 11Hz \times \frac{\mu F}{C_{TMR}}$ . The

on-chip timer will start to count down after initial power-up or every time it is enabled. This timer will limit the max trickle-charge time to 32768 internal oscillating cycles. If the charger stays in trickle mode for longer than 32768 cycles, it will be terminated and a fault will be set by floating  $\overline{CHG}$  pin. After fault reporting, the charger can be re-initiated only by recycling the power supply or SHDN signal. If the charger successfully goes through trickle charge within the allowed time limit, it will start CC charging and then CV charging. If the total charge time exceeds 262144 cycles and the battery full has not been qualified, the charger will be terminated and a fault will also be set by flashing  $\overline{CHG}$  pin at the rate of half the internal oscillation frequency. This function prevents charging a dead battery for prolonged duration. The timer function can be disabled by shorting TMR to ground.

**Thermal Protection**

The MP26053 has proprietary thermal protection to prevent the IC from overheating. When in thermal protection mode, the average charge current will be reduced to prevent the IC from overheating. Operating in thermal protection mode will slow down the charging process. Lowering the input voltage and enhancing thermal dissipation to the environment can effectively prevent the IC from going into thermal protection mode.



Under full charge conditions, certain systems may draw a very narrow current pulse that exceeds the IBF threshold. The  $\overline{\text{CHG}}$  indicator may glitch. It is desirable to blank the  $\overline{\text{CHG}}$  glitch

so that the system can properly indicate full charge conditions to the user. A simple solution is to add a RC filter on the  $\overline{\text{CHG}}$  pin to filter out the possible  $\overline{\text{CHG}}$  glitch, as shown in Figure 4.

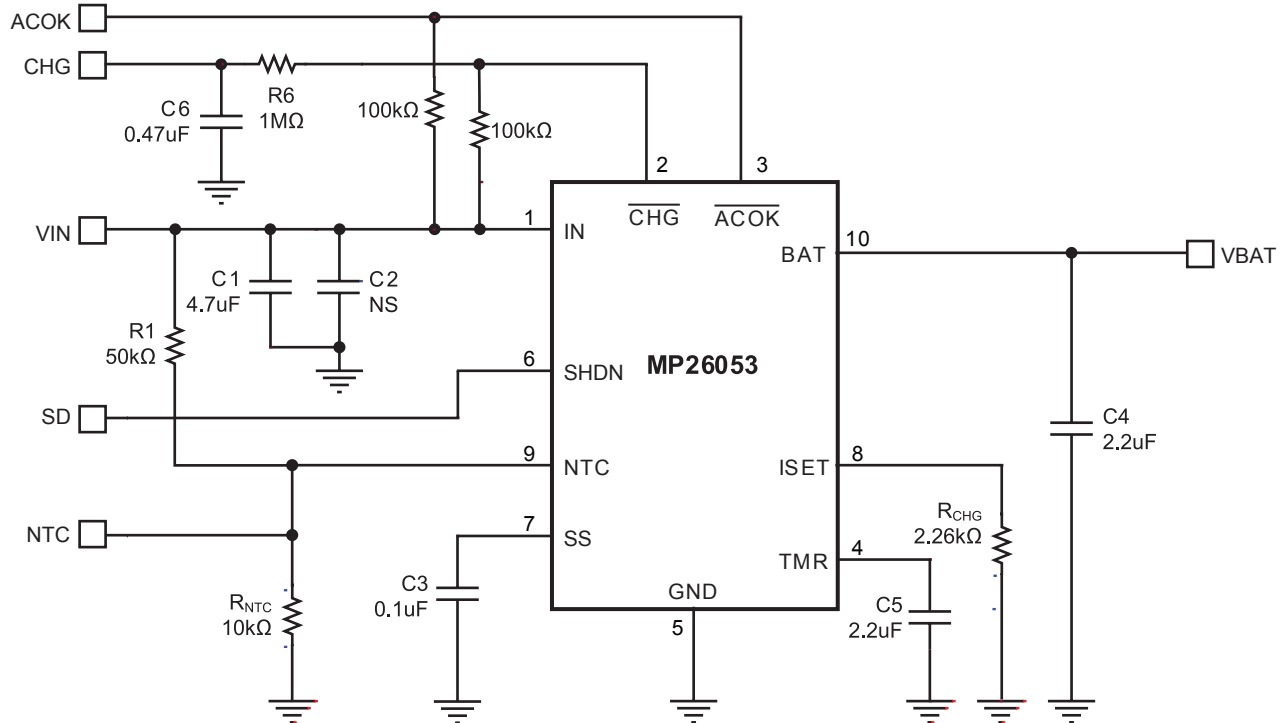

**Figure 4—Filtered Charge Status with GPIO Connection**

Power-On Reset (POR) feature can be applied to the MP26053 to ensure that the device starts operating in a known state. The flow chart in Figure 5 describes the conditions and operation

modes of the MP26053. CVC and CCC stand for “constant voltage charge” and “constant current charge”, respectively.

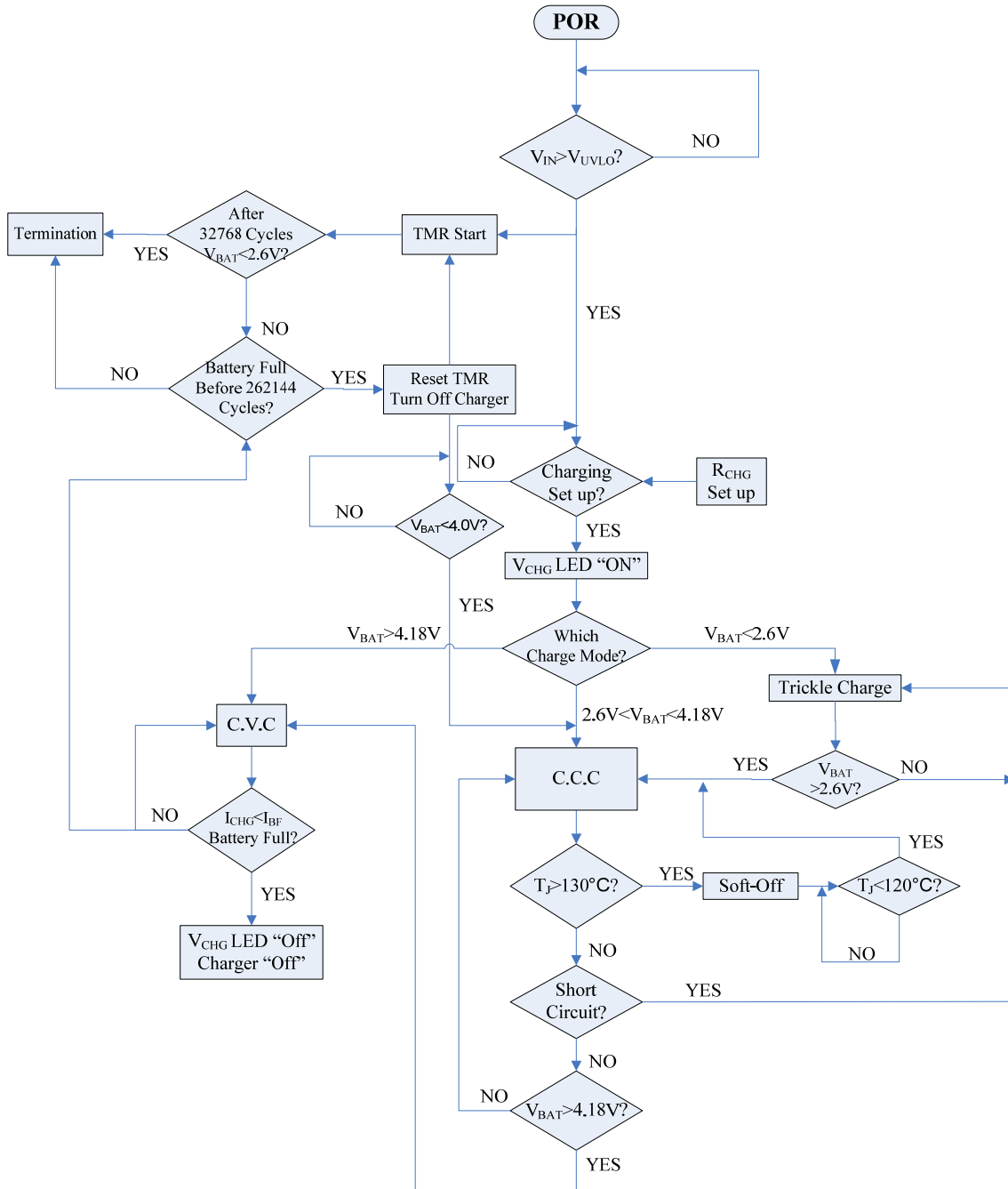

**Figure 5—Flow Chart of Operation**

