



STPS80H100CY

HIGH VOLTAGE POWER SCHOTTKY RECTIFIER

PRELIMINARY DATASHEET

MAIN PRODUCT CHARACTERISTICS

$I_{F(AV)}$	2 x 40 A
V_{RRM}	100 V
T_j (max)	175 °C
V_F (max)	0.70 V

FEATURES AND BENEFITS

- HIGH REVERSE VOLTAGE
- NEGLIGIBLE SWITCHING LOSSES
- LOW FORWARD VOLTAGE DROP
- LOW LEAKAGE CURRENT
- HIGH TEMPERATURE
- LOW THERMAL RESISTANCE

DESCRIPTION

Dual center tap Schottky rectifier suited for Switched Mode Power Supplies and high frequency DC to DC converters.

Packaged in Max247, this device is intended for use in high frequency computer and telecom converters.

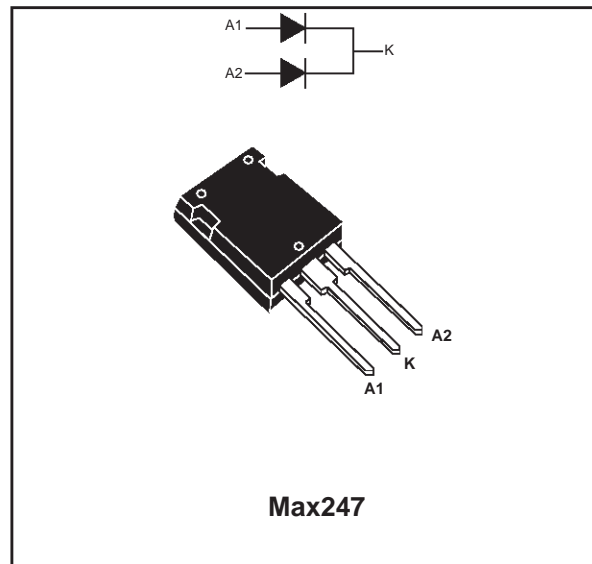

ABSOLUTE RATINGS (limiting values, per diode)

Symbol	Parameter		Value	Unit
V_{RRM}	Repetitive peak reverse voltage		100	V
$I_{F(RMS)}$	RMS forward current		50	A
$I_{F(AV)}$	Average forward current	$T_c = 155^\circ\text{C}$ $\delta = 0.5$	Per diode: 40 Per device: 80	A
I_{FSM}	Surge non repetitive forward current	$t_p = 10 \text{ ms}$ sinusoidal	400	A
I_{RRM}	Repetitive peak reverse current	$t_p = 2 \mu\text{s}$ square F = 1kHz	2	A
T_{stg}	Storage temperature range		- 65 to + 175	°C
T_j	Maximum operating junction temperature *		175	°C
dV/dt	Critical rate of rise of reverse voltage		10000	V/ μs

* : $\frac{dP_{tot}}{dT_j} < \frac{1}{R_{th(j-a)}}$ thermal runaway condition for a diode on its own heatsink

STPS80H100CY

THERMAL RESISTANCES

Symbol	Parameter	Value	Unit
R _{th(j-c)}	Junction to case	Per diode	0.7
		Total	0.5
R _{th(c)}	Coupling	0.3	°C/W

When the diodes 1 and 2 are used simultaneously :

$$\Delta T_j(\text{diode 1}) = P(\text{diode 1}) \times R_{th(j-c)}(\text{Per diode}) + P(\text{diode 2}) \times R_{th(c)}$$

STATIC ELECTRICAL CHARACTERISTICS (per diode)

Symbol	Parameter	Tests conditions	Min.	Typ.	Max.	Unit	
I _R *	Reverse leakage current	T _j = 25°C	V _R = V _{RRM}			20	μA
		T _j = 125°C			7	20	mA
V _F **	Forward voltage drop	T _j = 25°C	I _F = 40 A			0.8	V
		T _j = 125°C	I _F = 40 A		0.65	0.7	
		T _j = 25°C	I _F = 80 A			0.94	
		T _j = 125°C	I _F = 80 A		0.79	0.84	

Pulse test : * t_p = 5 ms, δ < 2 %

** t_p = 380 μs, δ < 2%

To evaluate the maximum conduction losses use the following equation :

$$P = 0.56 \times I_{F(AV)} + 0.0035 \times I_{F(RMS)}^2$$

Fig. 1: Average forward power dissipation versus average forward current (per diode).

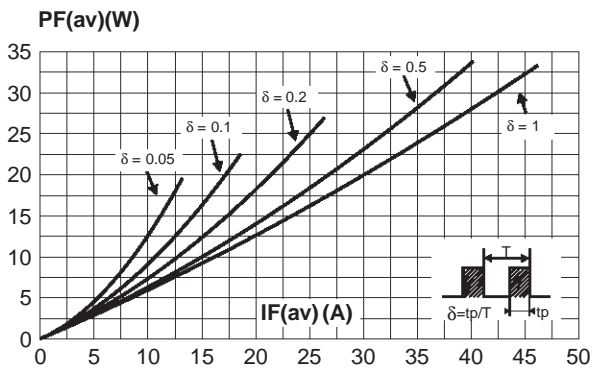

Fig. 2: Average forward current versus ambient temperature (δ=0.5, per diode).

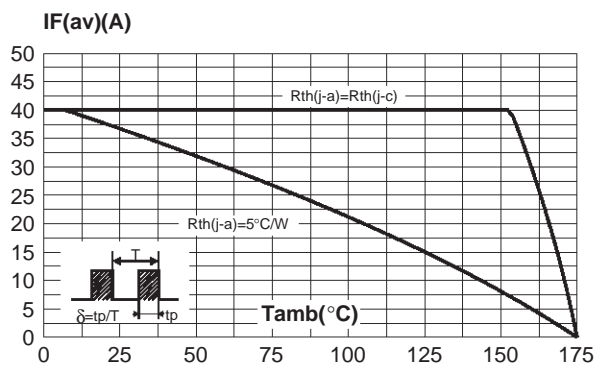

Fig. 3: Non repetitive surge peak forward current versus overload duration (maximum values, per diode).

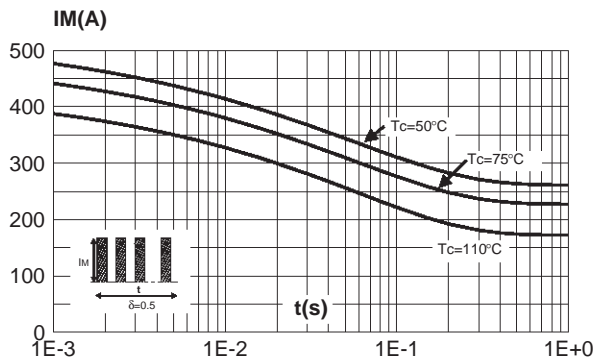

Fig. 4: Relative variation of thermal impedance junction to case versus pulse (per diode).

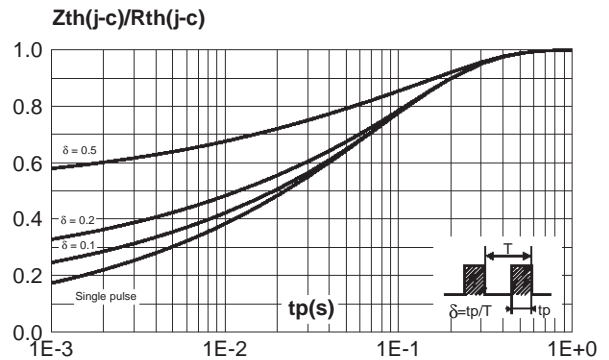

Fig. 5: Reverse leakage current versus reverse voltage applied (typical values, per diode).

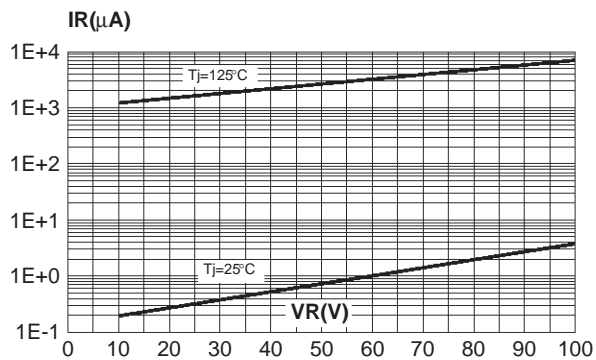

Fig. 6: Junction capacitance versus reverse voltage applied (typical values, per diode).

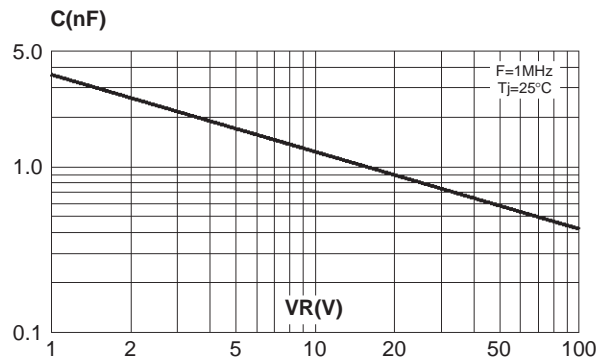
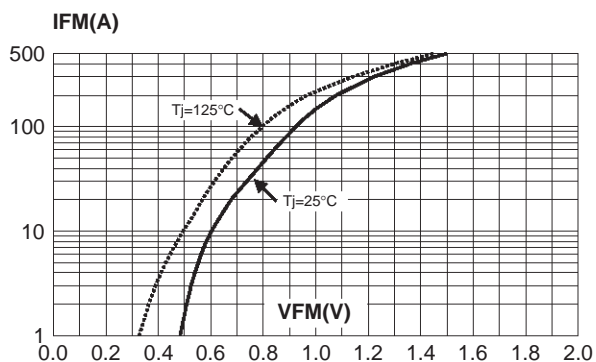

Fig. 7: Forward voltage drop versus forward current (maximum values, per diode).



STPS80H100CY

PACKAGE MECHANICAL DATA

Max247

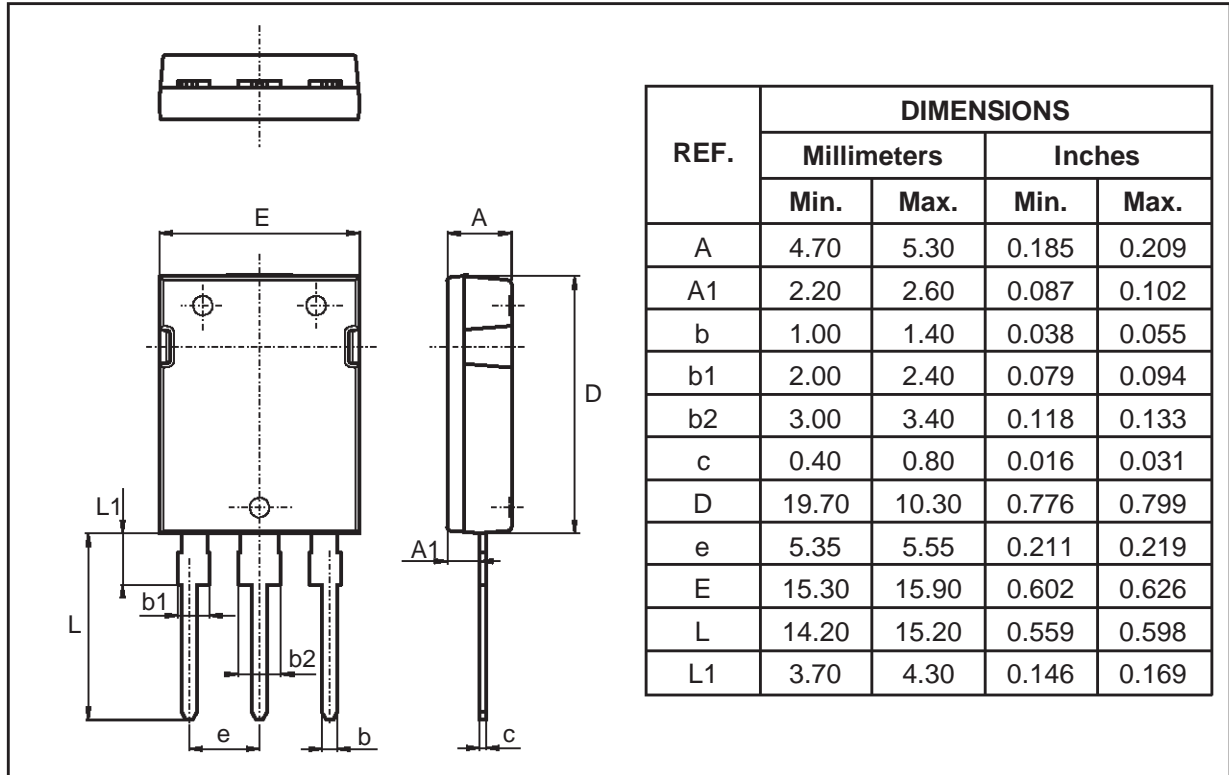

Ordering type	Marking	Package	Weight	Base qty	Delivery mode
STPS80H100CY	STPS80H100CY	Max247	4.4g	30	Tube

■ Epoxy meets UL94,V0

Information furnished is believed to be accurate and reliable. However, STMicroelectronics assumes no responsibility for the consequences of use of such information nor for any infringement of patents or other rights of third parties which may result from its use. No license is granted by implication or otherwise under any patent or patent rights of STMicroelectronics. Specifications mentioned in this publication are subject to change without notice. This publication supersedes and replaces all information previously supplied. STMicroelectronics products are not authorized for use as critical components in life support devices or systems without express written approval of STMicroelectronics.

The ST logo is a registered trademark of STMicroelectronics

© 1999 STMicroelectronics - Printed in Italy - All rights reserved.

STMicroelectronics GROUP OF COMPANIES

Australia - Brazil - China - Finland - France - Germany - Hong Kong - India - Italy - Japan - Malaysia
Malta - Morocco - Singapore - Spain - Sweden - Switzerland - United Kingdom - U.S.A.

<http://www.st.com>