

- Note: End stackable.
- Designed for JEDEC type devices.
- Open frame design in solder area improves results of IR soldering and facilitates visual inspection of solder pads.
- The brown PPS (Ryton R-4) insulator has optional polarizing pegs (PP).
- PLCC chip extraction tool available, see page 96.

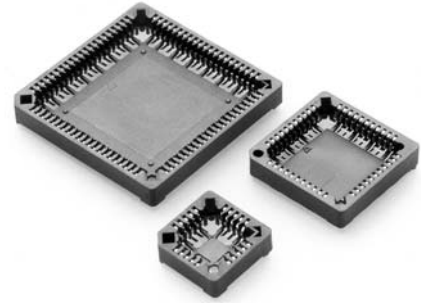

SURFACE MOUNT

PCB LAYOUT FOR SURFACE MOUNT

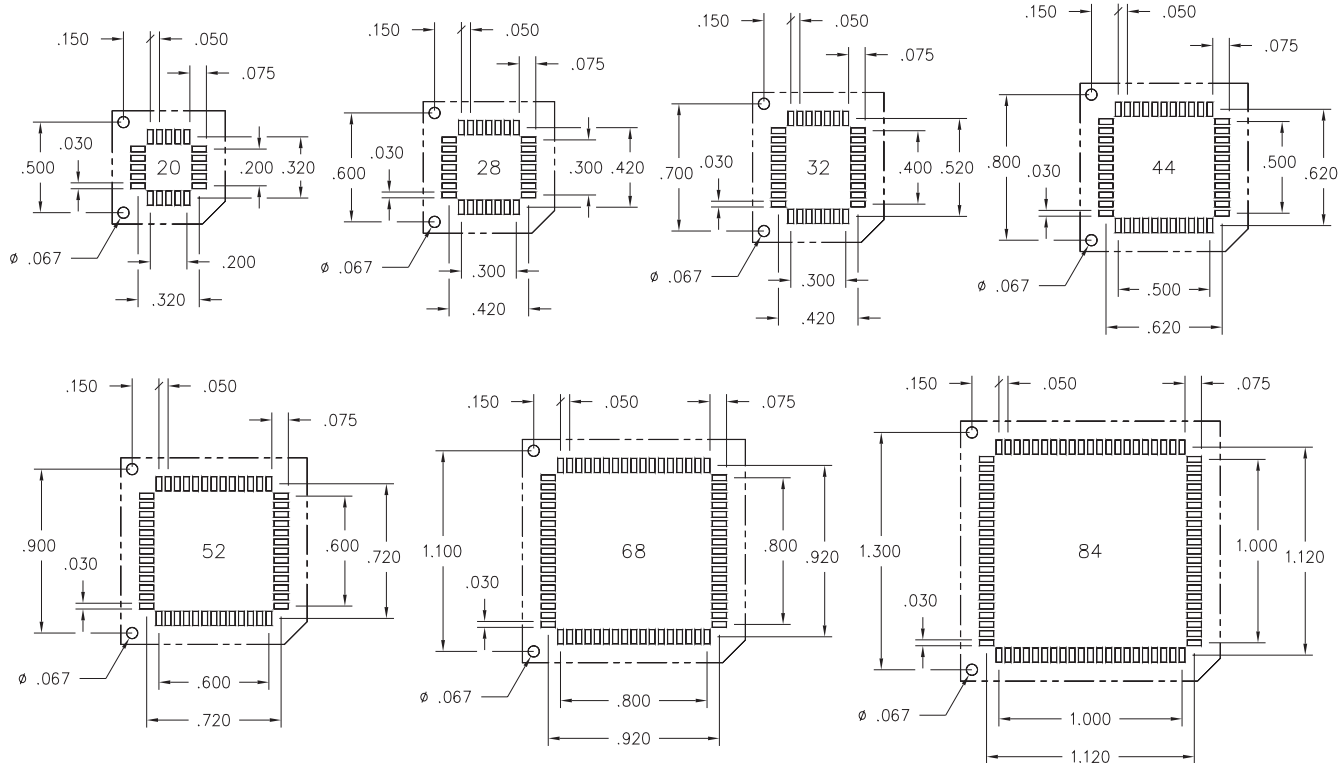

AVAILABLE PACKAGED IN TUBES OR ON TAPE AND REEL PER EIA-481

No. of Pins	ORDERING INFORMATION	A1	A2	C1	C2	E	H	Qty. per Tube	Tape Width mm	Qty. per Reel
20	540-99-020-17-400X0X	.200	.200	.585	.585	.657	.180	34	24	490
28	540-99-028-17-400X0X	.300	.300	.685	.685	.799	.180	29	32	400
32*	540-99-032-17-400X0X	.300	.400	.670	.770	.885	.148	26	32	400
44	540-99-044-17-400X0X	.500	.500	.885	.885	1.082	.180	22	44	250
52	540-99-052-17-400X0X	.600	.600	1.000	1.000	1.224	.180	20	44	250
68	540-99-068-17-400X0X	.800	.800	1.202	1.202	1.507	.180	16	44	250
84	540-99-084-17-400X0X	1.000	1.000	1.400	1.400	1.791	.180	14	56	200

\*Rectangular

X= 0 Without PP      X= 0 Tube Packaged  
X= 2 With PP          X= 4 Tape and Reel

ALL SERIES 540 CONTACTS ARE PLATED TIN/LEAD. SEE PAGE 96 FOR TECHNICAL SPECIFICATIONS.

THIS DRAWING CONTAINS INFORMATION PROPRIETARY TO MILL-MAX MFG. CORP.  
 ANY REPRODUCTION, DISCLOSURE OR USE OF THIS DOCUMENT IS PROHIBITED  
 WITHOUT THE WRITTEN CONSENT OF MILL-MAX MFG. CORP.®

REV.	DATE	REV. DESCRIPTION

**PRINTED CIRCUIT BOARD FOOTPRINT LAYOUT  
(TOP VIEW)**

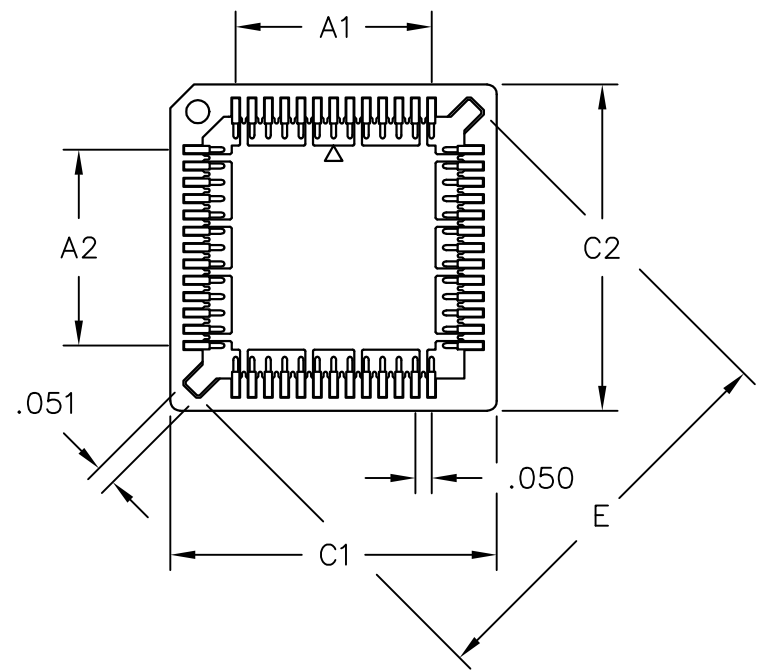
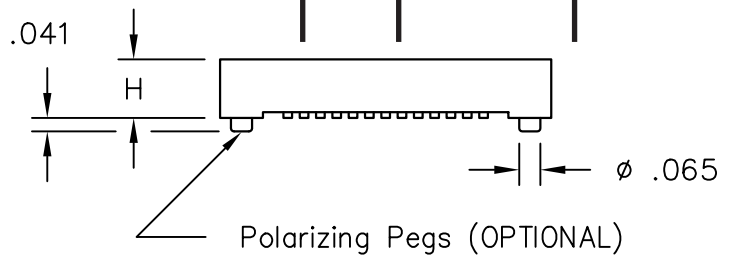
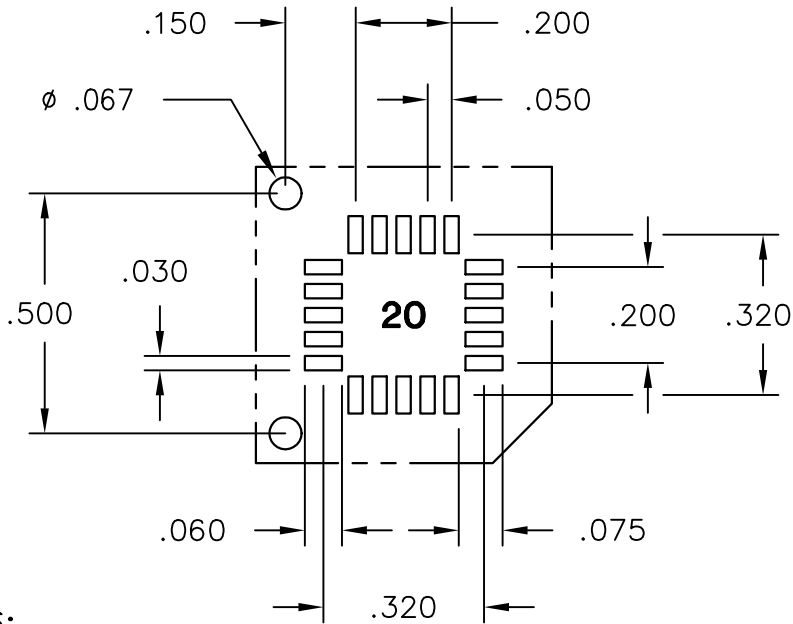

ORDER AS:

540-99-020-17-400X0X

X = 0 TUBE PACKAGED  
 X = 4 TAPE AND REEL

X = 0 WITHOUT POLORIZING PEGS  
 X = 2 WITH POLORIZING PEGS

- NOTES: End Stackable.
- Designed for JEDEC type MS-018 & MS-016 devices
- Contact Material: Copper Alloy.
- Contact Finish: Tin/Lead over Nickel.
- Insulator Material: (Brown) PPS Ryton R-4 Rated  
 UL 94 V-0.

Pins	- A1 -	- A2 -	- C1 -	- C2 -	- E -	- H -	Qty. per Tube	Qty. per Reel	Tape Width mm
20	.200	.200	.585	.585	.657	.180	34	490	24mm



**MILL-MAX® MFG. CORP.**  
 P.O. BOX 300, 190 PINE HOLLOW ROAD, OYSTER BAY, NY 11771-0300  
 TEL: (516) 922-6000 FAX: (516) 922-9253 WEB: WWW.MILL-MAX.COM

ALL DIMENSIONS IN INCHES		DATE	DRAWN	ENG. APPROVAL	SHEET NUMBER
PIN TOLERANCES BEFORE PLATING	INSULATOR TOLERANCES	10/08/02	D.M.		1 of 7
LENGTHS: ±.005	LENGTHS: ±.005	TITLE 20 PIN SMT PLCC PIN-OUT			
DIAMETERS: ±.002	THICKNESS: ±.003				
ANGLES: ±2°	HOLE TO HOLE: ±.001	CUSTOMER APPROVAL		DRAWING NUMBER	REV
	NON ACCUMULATIVE			540SERIES SMT	-

THIS DRAWING CONTAINS INFORMATION PROPRIETARY TO MILL-MAX MFG. CORP.  
 ANY REPRODUCTION, DISCLOSURE OR USE OF THIS DOCUMENT IS PROHIBITED  
 WITHOUT THE WRITTEN CONSENT OF MILL-MAX MFG. CORP.®

REV.	DATE	REV. DESCRIPTION

**PRINTED CIRCUIT BOARD FOOTPRINT LAYOUT  
(TOP VIEW)**

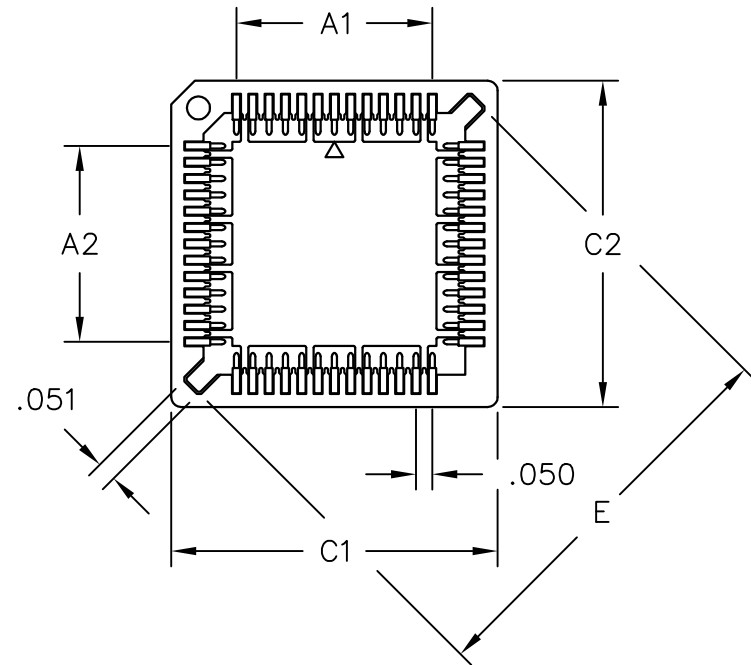
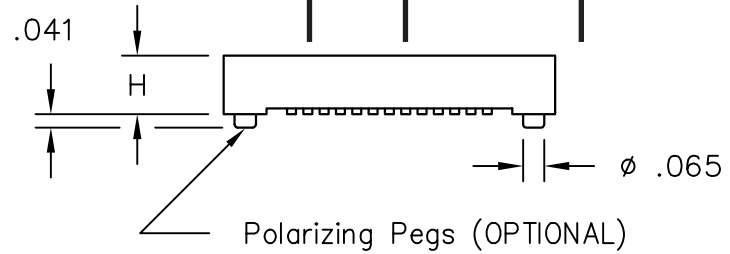
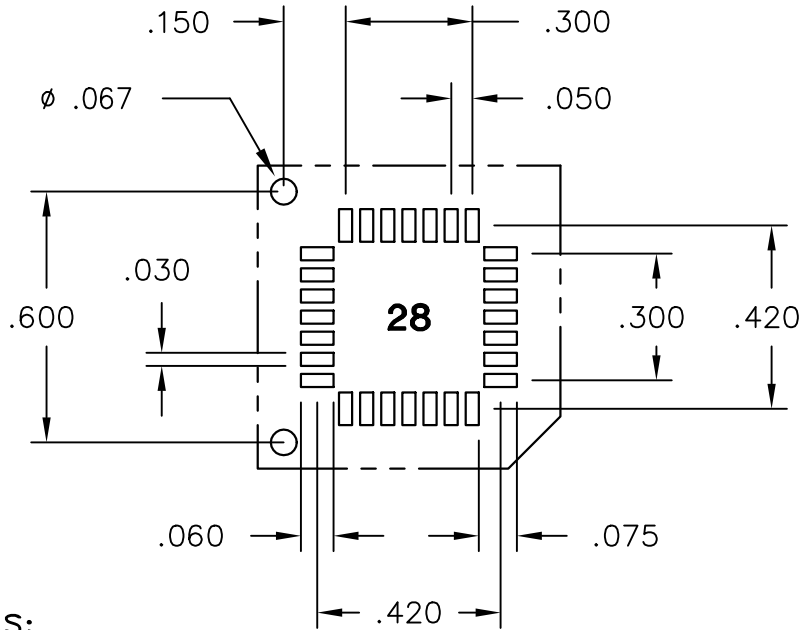

ORDER AS:

540-99-028-17-400X0X

X = 0 TUBE PACKAGED  
 X = 4 TAPE AND REEL

X = 0 WITHOUT POLORIZING PEGS  
 X = 2 WITH POLORIZING PEGS

- NOTES: End Stackable.
- Designed for JEDEC type MS-018 & MS-016 devices.
- Contact Material: Copper Alloy.
- Contact Finish: Tin/Lead over Nickel.
- Insulator Material: (Brown) PPS Ryton R-4 Rated  
 UL 94 V-0.

Pins	- A1 -	- A2 -	- C1 -	- C2 -	- E -	- H -	Qty. per Reel	Qty. per Tube	Tape Width mm
28	.300	.300	.685	.685	.799	.180	29	400	32mm



**MILL-MAX® MFG. CORP.**

P.O. BOX 300, 190 PINE HOLLOW ROAD, OYSTER BAY, NY 11771-0300  
 TEL: (516) 922-6000 FAX: (516) 922-9253 WEB: WWW.MILL-MAX.COM

**ALL DIMENSIONS IN INCHES**

PIN TOLERANCES BEFORE PLATING	INSULATOR TOLERANCES
LENGTHS: ±.005	LENGTHS: ±.005
DIAMETERS: ±.002	THICKNESS: ±.003
ANGLES: ±2°	HOLE TO HOLE: ±.001
	NON ACCUMULATIVE

DATE	DRAWN	ENG. APPROVAL	SHEET NUMBER
10/08/02	D.M.		2 of 7
TITLE 28 PIN SMT PLCC PIN-OUT			
CUSTOMER APPROVAL		DRAWING NUMBER 540SERIESSMT	REV -

THIS DRAWING CONTAINS INFORMATION PROPRIETARY TO MILL-MAX MFG. CORP.  
 ANY REPRODUCTION, DISCLOSURE OR USE OF THIS DOCUMENT IS PROHIBITED  
 WITHOUT THE WRITTEN CONSENT OF MILL-MAX MFG. CORP.®

REV.	DATE	REV. DESCRIPTION

**PRINTED CIRCUIT BOARD FOOTPRINT LAYOUT  
 (TOP VIEW)**

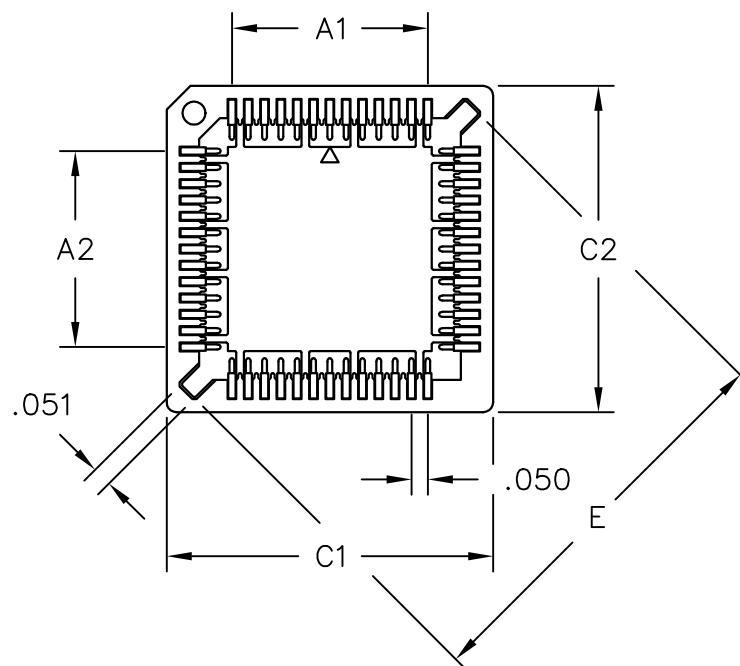
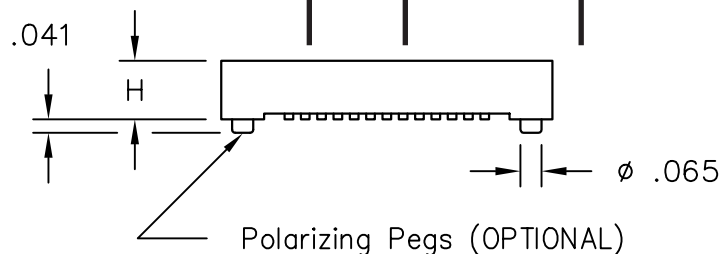
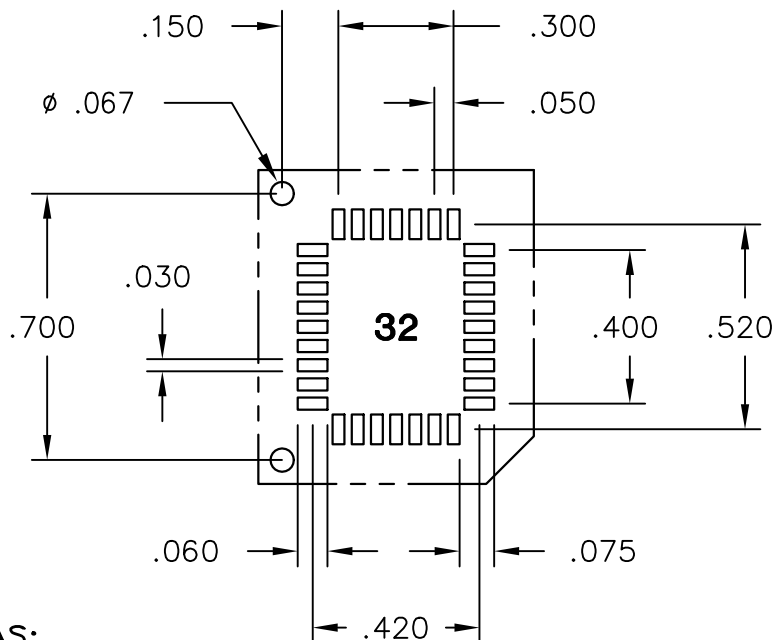

ORDER AS:

**540-99-032-17-400X0X**

X = 0 TUBE PACKAGED  
 X = 4 TAPE AND REEL

X = 0 WITHOUT POLORIZING PEGS  
 X = 2 WITH POLORIZING PEGS

- NOTES: End Stackable.
- Designed for JEDEC type MS-018 & MS-016 devices.
- Contact Material: Copper Alloy.
- Contact Finish: Tin/Lead over Nickel.
- Insulator Material: (Brown) PPS Ryton R-4 Rated  
 UL 94 V-0.

Pins	- A1 -	- A2 -	- C1 -	- C2 -	- E -	- H -	Qty. per Reel	Qty. per Tube	Tape Width mm
32	.300	.400	.670	.770	.885	.148	26	400	32mm



**MILL-MAX® MFG. CORP.**

P.O. BOX 300, 190 PINE HOLLOW ROAD, OYSTER BAY, NY 11771-0300  
 TEL: (516) 922-6000 FAX: (516) 922-9253 WEB: WWW.MILL-MAX.COM

**ALL DIMENSIONS IN INCHES**

PIN TOLERANCES BEFORE PLATING	INSULATOR TOLERANCES
LENGTHS: ±.005	LENGTHS: ±.005
DIAMETERS: ±.002	THICKNESS: ±.003
ANGLES: ±2°	HOLE TO HOLE: ±.001
	NON ACCUMULATIVE

DATE	DRAWN	ENG. APPROVAL	SHEET NUMBER
10/08/02	D.M.		3 of 7
TITLE 32 PIN SMT PLCC PIN-OUT			
CUSTOMER APPROVAL		DRAWING NUMBER 540SERIES SMT	REV -

THIS DRAWING CONTAINS INFORMATION PROPRIETARY TO MILL-MAX MFG. CORP.  
 ANY REPRODUCTION, DISCLOSURE OR USE OF THIS DOCUMENT IS PROHIBITED  
 WITHOUT THE WRITTEN CONSENT OF MILL-MAX MFG. CORP.®

REV.	DATE	REV. DESCRIPTION

**PRINTED CIRCUIT BOARD FOOTPRINT LAYOUT  
(TOP VIEW)**

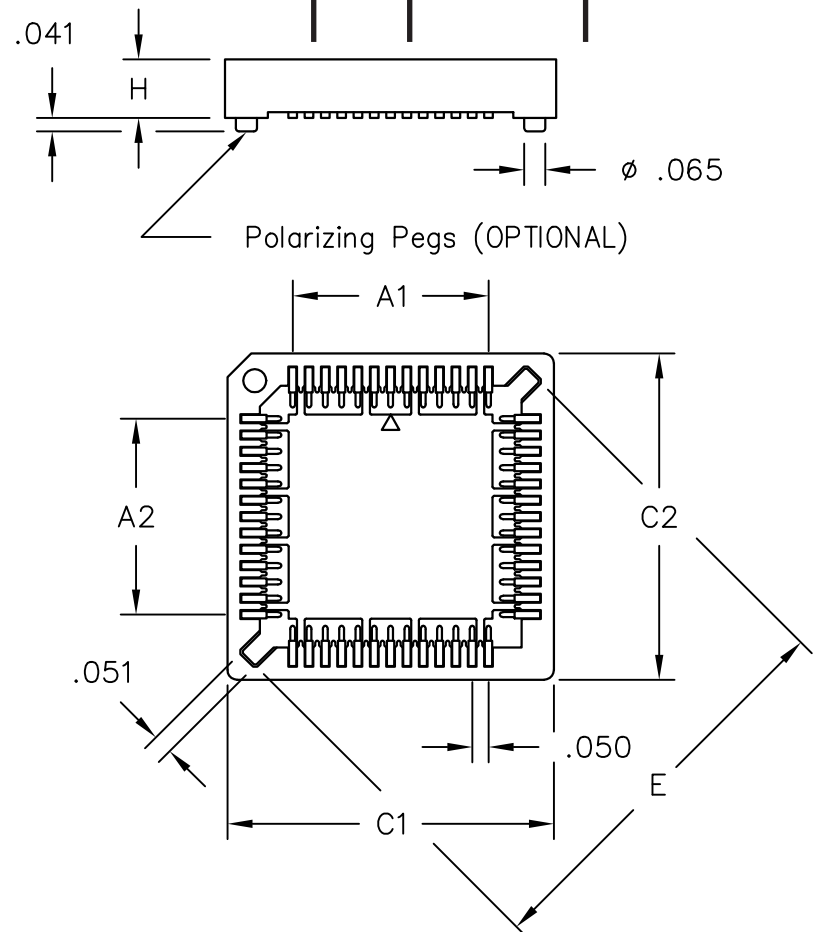
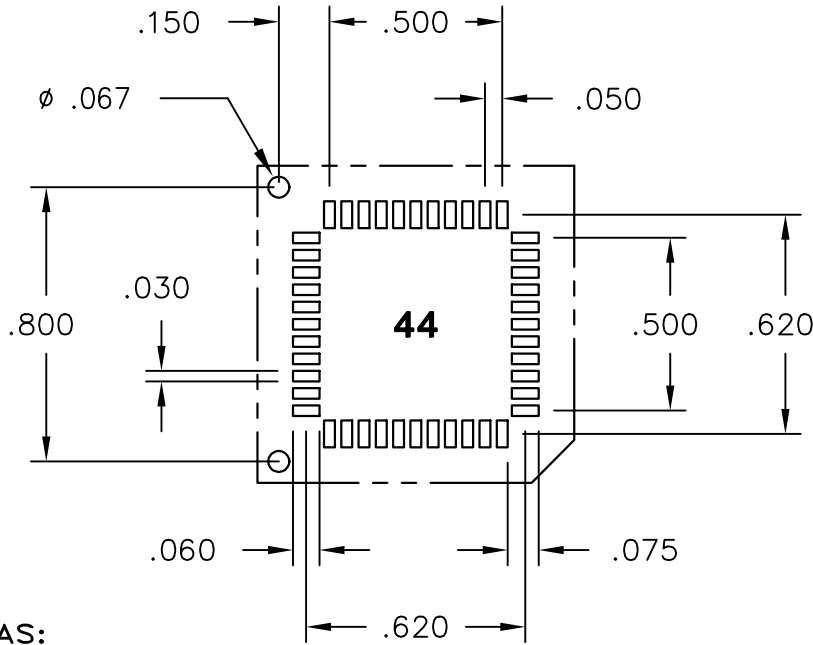

ORDER AS:

540-99-044-17-400X0X

X = 0 TUBE PACKAGED  
 X = 4 TAPE AND REEL

X = 0 WITHOUT POLORIZING PEGS  
 X = 2 WITH POLORIZING PEGS

- NOTES: End Stackable.
- Designed for JEDEC type MS-018 & MS-016 devices.
- Contact Material: Copper Alloy.
- Contact Finish: Tin/Lead over Nickel.
- Insulator Material: (Brown) PPS Ryton R-4 Rated  
 UL 94 V-0.

Pins	- A1 -	- A2 -	- C1 -	- C2 -	- E -	- H -	Qty. per Reel	Qty. per Tube	Tape Width mm
44	.500	.500	.885	.885	1.082	.180	22	250	44mm



**MILL-MAX® MFG. CORP.**  
 P.O. BOX 300, 190 PINE HOLLOW ROAD, OYSTER BAY, NY 11771-0300  
 TEL: (516) 922-6000 FAX: (516) 922-9253 WEB: WWW.MILL-MAX.COM

ALL DIMENSIONS IN INCHES		DATE	DRAWN	ENG. APPROVAL	SHEET NUMBER
PIN TOLERANCES BEFORE PLATING	INSULATOR TOLERANCES	10/08/02	D.M.		4 of 7
LENGTHS: ±.005	LENGTHS: ±.005	TITLE 44 PIN SMT PLCC PIN-OUT			
DIAMETERS: ±.002	THICKNESS: ±.003				
ANGLES: ±2°	HOLE TO HOLE: ±.001	CUSTOMER APPROVAL		DRAWING NUMBER	REV
	NON ACCUMULATIVE			540SERIESSMT	-

THIS DRAWING CONTAINS INFORMATION PROPRIETARY TO MILL-MAX MFG. CORP.  
 ANY REPRODUCTION, DISCLOSURE OR USE OF THIS DOCUMENT IS PROHIBITED  
 WITHOUT THE WRITTEN CONSENT OF MILL-MAX MFG. CORP.®

REV.	DATE	REV. DESCRIPTION

**PRINTED CIRCUIT BOARD FOOTPRINT LAYOUT  
(TOP VIEW)**

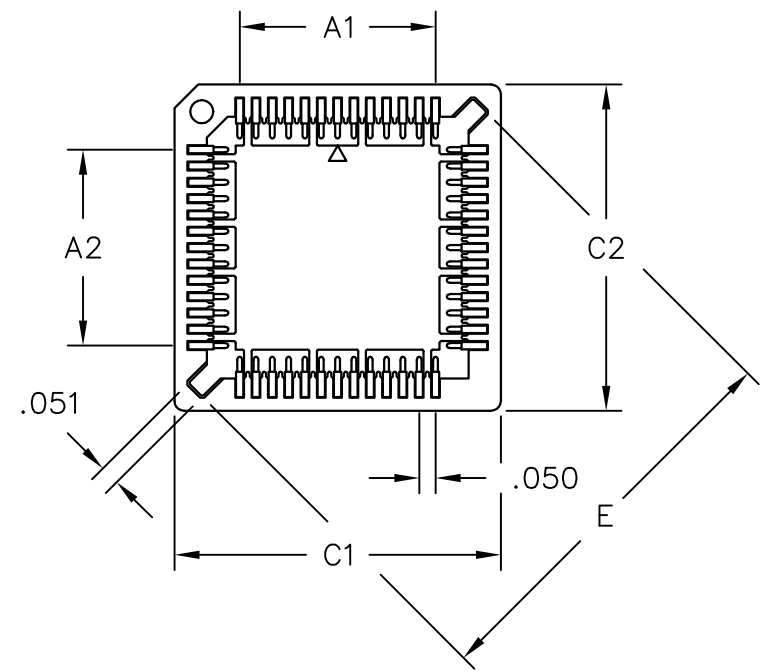
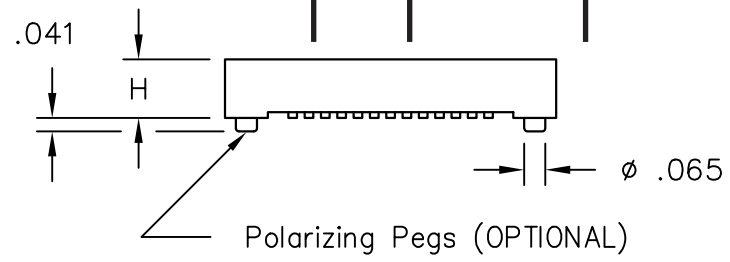
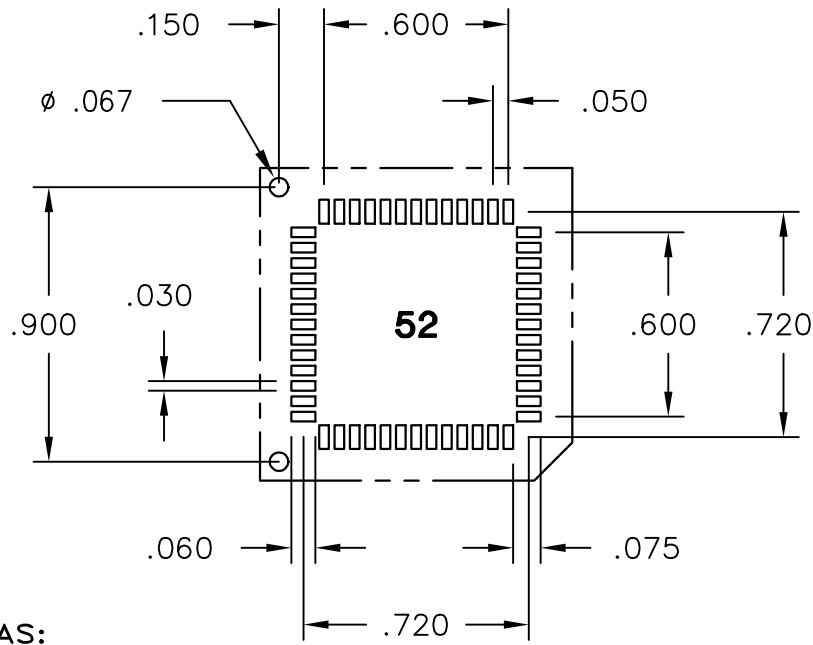

ORDER AS:

540-99-052-17-400X0X

X = 0 TUBE PACKAGED  
 X = 4 TAPE AND REEL

X = 0 WITHOUT POLORIZING PEGS  
 X = 2 WITH POLORIZING PEGS

- NOTES: End Stackable.
- Designed for JEDEC type MS-018 & MS-016 devices.
- Contact Material: Copper Alloy.
- Contact Finish: Tin/Lead over Nickel.
- Insulator Material: (Brown) PPS Ryton R-4 Rated  
 UL 94 V-0.

Pins	- A1 -	- A2 -	- C1 -	- C2 -	- E -	- H -	Qty. per Reel	Qty. per Tube	Tape Width mm
52	.600	.600	1.000	1.000	1.224	.180	20	250	44mm



**MILL-MAX® MFG. CORP.**  
 P.O. BOX 300, 190 PINE HOLLOW ROAD, OYSTER BAY, NY 11771-0300  
 TEL: (516) 922-6000 FAX: (516) 922-9253 WEB: WWW.MILL-MAX.COM

ALL DIMENSIONS IN INCHES		DATE	DRAWN	ENG. APPROVAL	SHEET NUMBER
PIN TOLERANCES BEFORE PLATING	INSULATOR TOLERANCES	10/08/02	D.M.		5 of 7
LENGTHS: ±.005	LENGTHS: ±.005	TITLE 52 PIN SMT PLCC PIN-OUT			
DIAMETERS: ±.002	THICKNESS: ±.003				
ANGLES: ±2°	HOLE TO HOLE: ±.001	CUSTOMER APPROVAL		DRAWING NUMBER	REV
	NON ACCUMULATIVE			540SERIES SMT	-

THIS DRAWING CONTAINS INFORMATION PROPRIETARY TO MILL-MAX MFG. CORP.  
 ANY REPRODUCTION, DISCLOSURE OR USE OF THIS DOCUMENT IS PROHIBITED  
 WITHOUT THE WRITTEN CONSENT OF MILL-MAX MFG. CORP.®

REV.	DATE	REV. DESCRIPTION

**PRINTED CIRCUIT BOARD FOOTPRINT LAYOUT  
(TOP VIEW)**

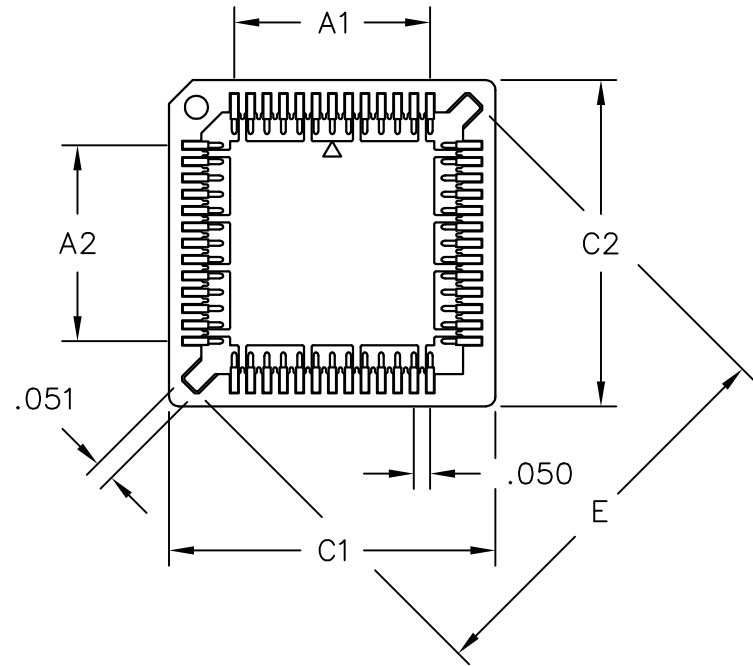
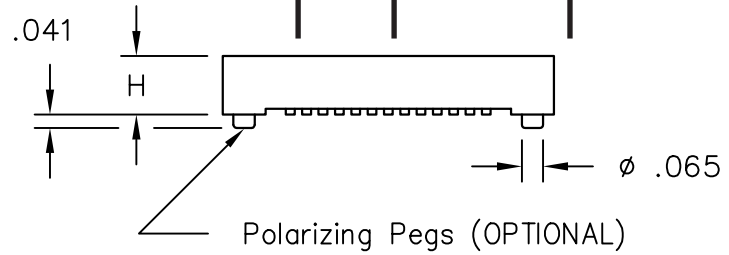
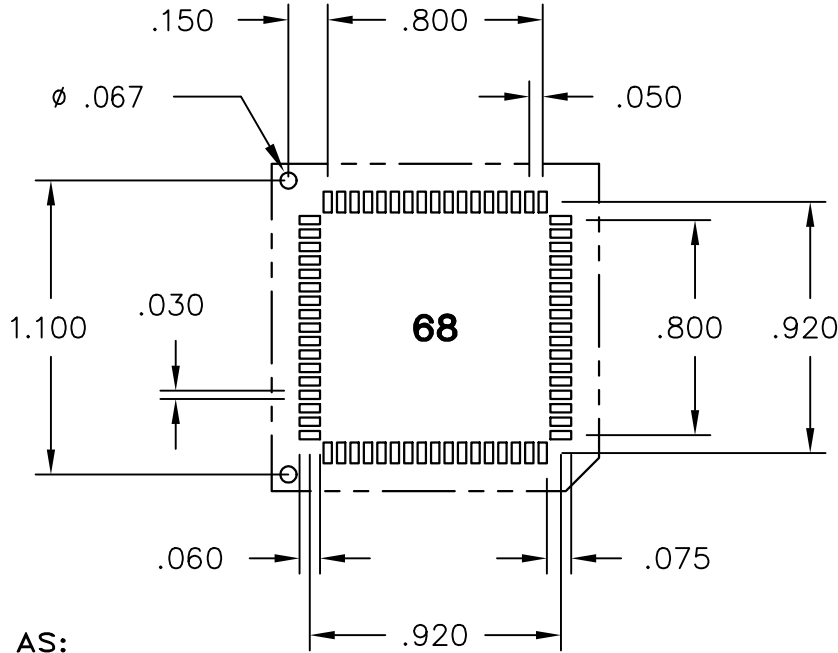

ORDER AS:

540-99-068-17-400X0X

X = 0 TUBE PACKAGED  
 X = 4 TAPE AND REEL

X = 0 WITHOUT POLORIZING PEGS  
 X = 2 WITH POLORIZING PEGS

- NOTES: End Stackable.
- Designed for JEDEC type MS-018 & MS-016 devices.
- Contact Material: Copper Alloy.
- Contact Finish: Tin/Lead over Nickel.
- Insulator Material: (Brown) PPS Ryton R-4 Rated  
 UL 94 V-0.

Pins	- A1 -	- A2 -	- C1 -	- C2 -	- E -	- H -	Qty. per Reel	Qty. per Tube	Tape Width mm
68	.800	.800	1.202	1.202	1.507	.180	16	250	44mm



**MILL-MAX® MFG. CORP.**

P.O. BOX 300, 190 PINE HOLLOW ROAD, OYSTER BAY, NY 11771-0300  
 TEL: (516) 922-6000 FAX: (516) 922-9253 WEB: WWW.MILL-MAX.COM

ALL DIMENSIONS IN INCHES		DATE	DRAWN	ENG. APPROVAL	SHEET NUMBER
PIN TOLERANCES BEFORE PLATING LENGTHS: ±.005 DIAMETERS: ±.002 ANGLES: ±2°		10/08/02	D.M.		6 of 7
INSULATOR TOLERANCES LENGTHS: ±.005 THICKNESS: ±.003 HOLE TO HOLE: ±.001 NON ACCUMULATIVE		TITLE 68 PIN SMT PLCC PIN-OUT			
CUSTOMER APPROVAL			DRAWING NUMBER		REV
			540SERIESSMT		-

THIS DRAWING CONTAINS INFORMATION PROPRIETARY TO MILL-MAX MFG. CORP.  
 ANY REPRODUCTION, DISCLOSURE OR USE OF THIS DOCUMENT IS PROHIBITED  
 WITHOUT THE WRITTEN CONSENT OF MILL-MAX MFG. CORP.®

REV.	DATE	REV. DESCRIPTION

**PRINTED CIRCUIT BOARD FOOTPRINT LAYOUT  
(TOP VIEW)**

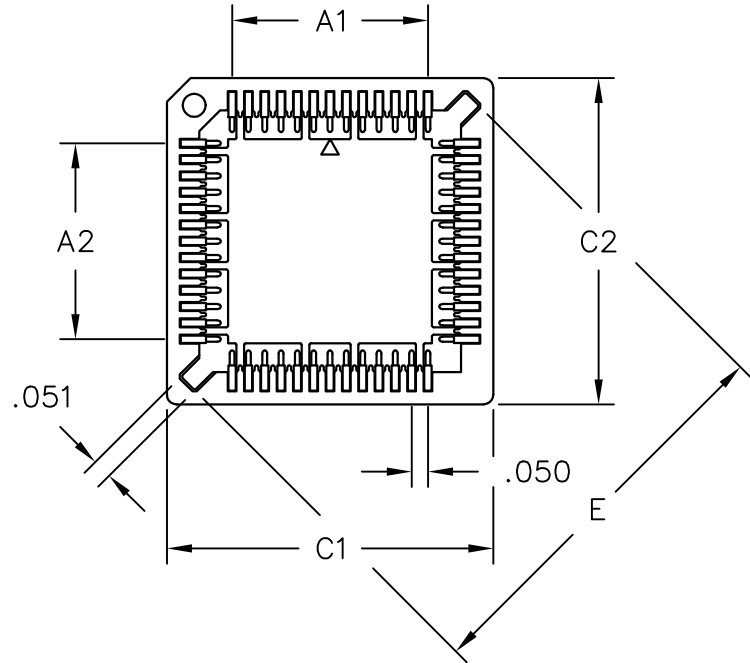
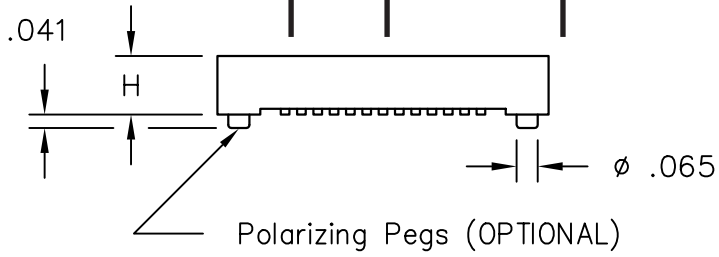
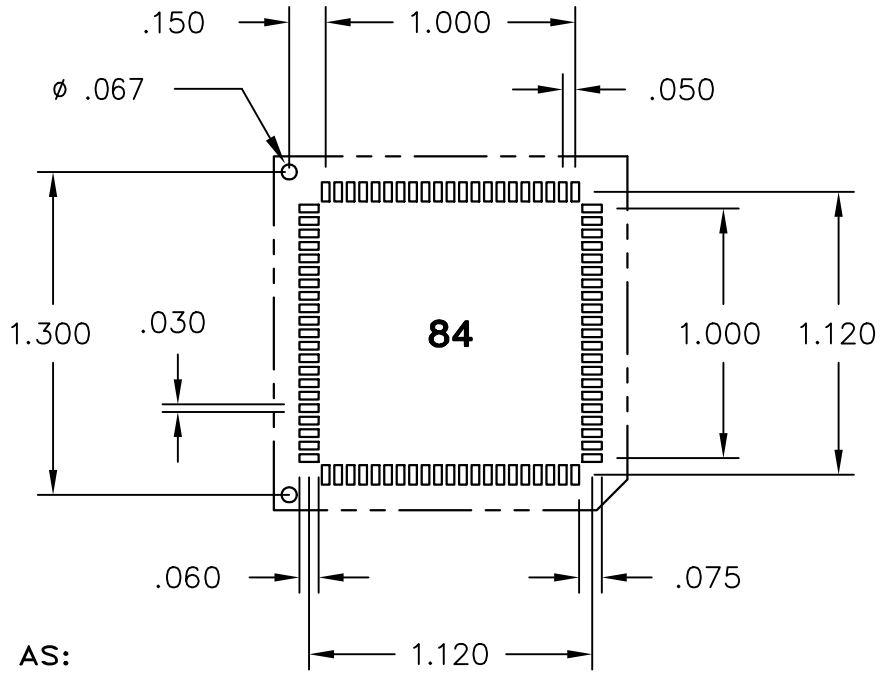

ORDER AS:

540-99-084-17-400XOX

X = 0 TUBE PACKAGED  
 X = 4 TAPE AND REEL

X = 0 WITHOUT POLORIZING PEGS  
 X = 2 WITH POLORIZING PEGS

- NOTES: End Stackable.
- Designed for JEDEC type MS-018 & MS-016 devices.
- Contact Material: Copper Alloy.
- Contact Finish: Tin/Lead over Nickel.
- Insulator Material: (Brown) PPS Ryton R-4 Rated  
 UL 94 V-0.

Pins	- A1 -	- A2 -	- C1 -	- C2 -	- E -	- H -	Qty. per Reel	Qty. per Tube	Tape Width mm
84	1.000	1.000	1.400	1.400	1.791	.180	14	200	56mm



**MILL-MAX® MFG. CORP.**  
 P.O. BOX 300, 190 PINE HOLLOW ROAD, OYSTER BAY, NY 11771-0300  
 TEL: (516) 922-6000 FAX: (516) 922-9253 WEB: WWW.MILL-MAX.COM

ALL DIMENSIONS IN INCHES		DATE	DRAWN	ENG. APPROVAL	SHEET NUMBER
PIN TOLERANCES BEFORE PLATING	INSULATOR TOLERANCES	10/08/02	D.M.		7 of 7
LENGTHS: ±.005	LENGTHS: ±.005	TITLE 84 PIN SMT PLCC PIN-OUT			
DIAMETERS: ±.002	THICKNESS: ±.003				
ANGLES: ±2°	HOLE TO HOLE: ±.001	CUSTOMER APPROVAL		DRAWING NUMBER	REV
	NON ACCUMULATIVE			540SERIES SMT	-