

Venture Lighting

Bright Ideas

Bold Innovations



NEW!
Ceramic Master-PLUS
lamp range see
Pages 20 - 21



Who is Venture? - An Innovator and Worldwide Manufacturer



Venture Lighting, the fastest growing metal halide lighting company in the world, is the only one concentrated on this technology. Since 1983, we've created a constant stream of new systems for our customers. Our range of optimized lamps and control gear, including the revolutionary Uni-Form® pulse start system, has grown to encompass lamp wattages 35 to 2,000. This unique focus offers you peak performance lighting solutions.

Our North American headquarters includes a state-of-the-art development and new products manufacturing center to support our leadership in originating new systems. The company is part of Advanced Lighting Technologies Inc. (ADLT) Our sister companies feature complementary capabilities: APL Engineered Materials (APL) is a strategic supplier of halides, amalgams and other components to the lighting industry. Deposition Sciences, Inc. (DSI) is a leader in sophisticated thin film coatings and deposition systems to the lighting industry.

Global Perspective

Venture maintains a worldwide network of low cost, lean manufacturing facilities. Quality is sustained through control systems constructed to meet ISO 9001 standards. Along with our premier lamp facility in North America. Our Indian facility, the largest metal halide plant in the Pacific Rim, produces both lamps and control gear.



Contents



Venture Lighting Europe	4
Simply a Better Metal Halide Lamp	5
The Secret is in the Shape	6
Additional Protection	7
White-Lux HPS Replacement Lamps	8
Open Rated Horizontal Tubular Lamps	9
White-Lux Plus	10
White-Lux Plus	11
Energy Saving Lamps	12
Uniform Pulse Start Energy Saving	13
Uniform Pulse Start High Performance	14
Tubular Lamps	15
Euro Metal Halide	16
Euro Metal Halide	17
Natural White Full Spectrum	18
Natural White	19
New Ceramic Master-PLUS Metal Halide	20
New Ceramic Master-PLUS Metal Halide	21
CWA	22
High Wattage Lamps	23
Double Ended and G12	24
Designer Colour	25
Aquatic and Special Purpose Lamps	26
Description Codes and Ordering Information	27
Ventronic Dimmable HID Control Gear	28
Ventronic POD	31
Ventronic Low Wattage	32
Ventronic HID Control Gear	33
Venture Parmar Ballasts	34
The P-Range HID Ballasts	36
The MCI Series Ignitor	37
Control Gear for HPS, MH & Ceramic MH Lamps 35W 50W & 70W	38
Control Gear for HPS, MH & Ceramic MH Lamps 100W 150W & 200W	40
Control Gear for HPS, MH & Ceramic MH Lamps 250W	41
Control Gear for HPS, MH & Ceramic MH Lamps 400W	42
Control Gear for MH & Ceramic MH Lamps 350W 400W & 450W	43
Control Gear for HPS, MH Lamps 600W 1000W 1500W & 2000W	44
Control Gear for Mercury Lamps / SOX Lamps 50W - 1000W Mercury Lamps 35W - 135W SOX Lamps	45
Control Gear for CWA, MH, Other Lamps, Lamp Detecting Device & Auto Transformers	46
High Power Factor Conversion Kits	47
Ignitors	48
Capacitors	49
Circuit Diagrams	51
Glossary of Terms	54
Warranty	55

Venture Lighting - Europe

Our modern European Headquarters are based in Rickmansworth, Hertfordshire just two miles away from the M25, 20 minutes from Heathrow and close to Rickmansworth station with its links to central London.

The offices house our sales and marketing operations, administration offices, as well as our customer service teams for the UK and our European Distribution network.

Our new Technical and Distribution Centre located in Castle Donington, Derbyshire offers full technical support on all our products

We believe that the best products in Metal Halide today should be complemented by the very best service and support.

That's why we strive to offer our customers, large and small, a level of service unequalled in the industry. Our dedicated UK customer service team supported by our experienced technical department is always there to provide expert product advice and to help you with all your Metal Halide requirements.

We also pride ourselves on excellent stock availability and a next day delivery service that's the envy of the industry. Our new purpose-built warehousing and distribution facilities have been designed to improve our service even more.

In fact our emphasis on quality service is just one further reason why more and more installers, specifiers and OEMs are switching to Venture Lighting for all their Metal Halide requirements.

As a Venture Lighting customer, you're assured the very best technology combined with the very highest level of service. In short, everything you'd expect from a global leader in the industry.



Simply a Better Metal Halide Lamp

Quality

- Exclusive formed body arc tube for consistency beyond ceramic metal halide
- Patented stronger weldless mount construction to minimise delivery and handling breakages
- 'Tipless' arc tube improves performance for maximum colour and light output uniformity

Performance

- Longer lamp life
- Enhanced lumen maintenance
- Excellent system colour uniformity
- Hot restart in less than half the time of standard pinch body metal halide systems
- 50% faster warm-up

Safety

- Shrouded 'open-rated' lamps to provide protection for luminaires without lenses
- UV Shield - blocks up to 80% UV, 50% more than most UV-reducing lamps
- Reduces UV damage to merchandise and signage
- Additional GlassGuard coating available for additional protection against breakage

Selection

- Venture's Uni-Form pulse start series of lamps has the greatest selection of lumen packages: 50W to 450W
- Most comprehensive range of open-rated products available in the industry

Exclusive tipless arc tube - totally uniform shape further improves performance for maximum colour and light output uniformity

Unique formed body arc tube - shaped to follow the curve of the arc stream to deliver superior lamp efficacy

Safety shroud with UV Shield® - blocks up to 80% UV, 50% more than most UV-reducing lamps to prevent Polycarbonate fixtures from yellowing

Patented stronger weldless mount construction - no welds mean less breakage during shipping and handling

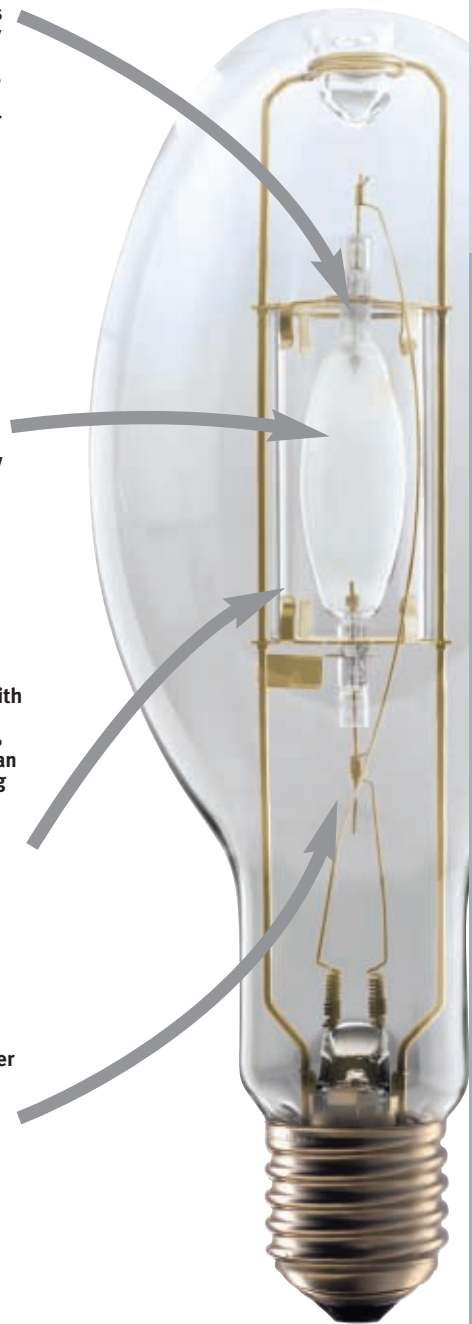

Color Uniformity - MacAdam Ellipses

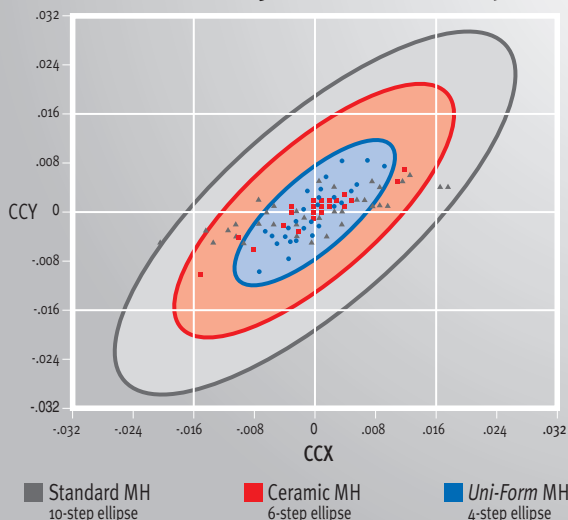

The Secret is in the Shape

Venture's Unique Formed Body Arc Tube Technology

- Superior colour uniformity, less deviation from lamp to lamp - Consistency beyond ceramic metal halide
- Highest lamp efficacy
- Patented stronger weldless arc tube mounting technology
- Higher maintained lumens, longer lamp life
- Hot restart in less than half the time of regular metal halide
- 50% faster warm-up

The Tipless Difference

- Unique formed body arc tube
 - shaped to follow the curve of the arc stream delivers superior lamp efficacy
- Exclusive tipless arc tube
 - Totally uniform shape further improves performance for maximum colour and light output uniformity

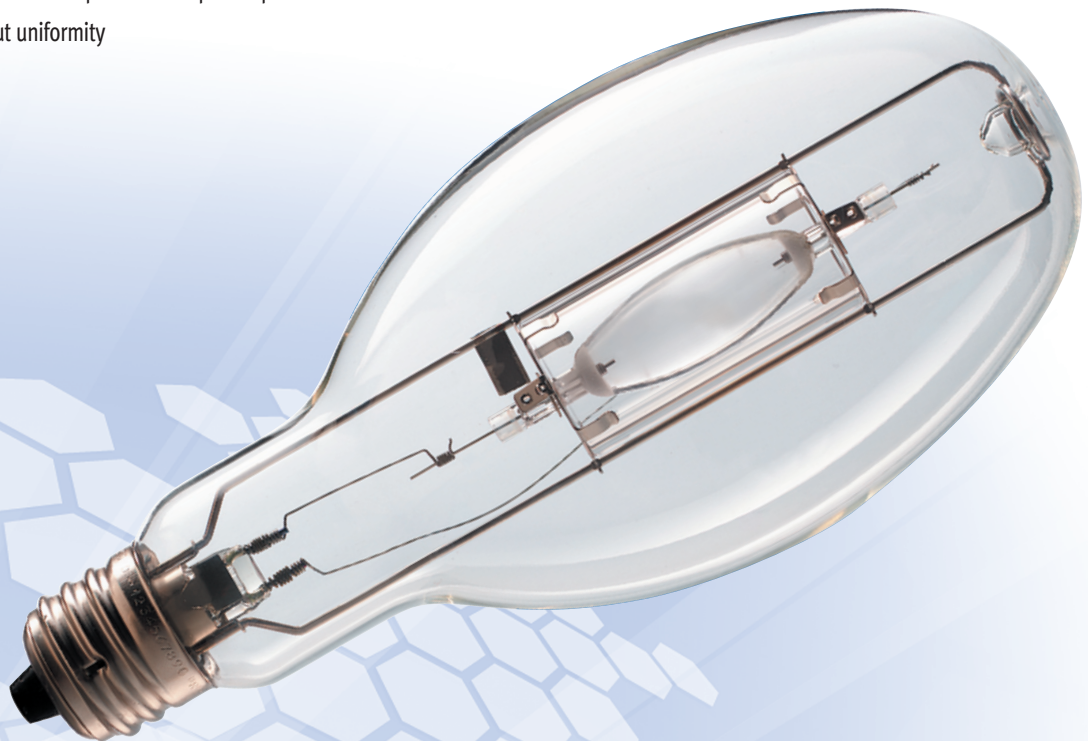
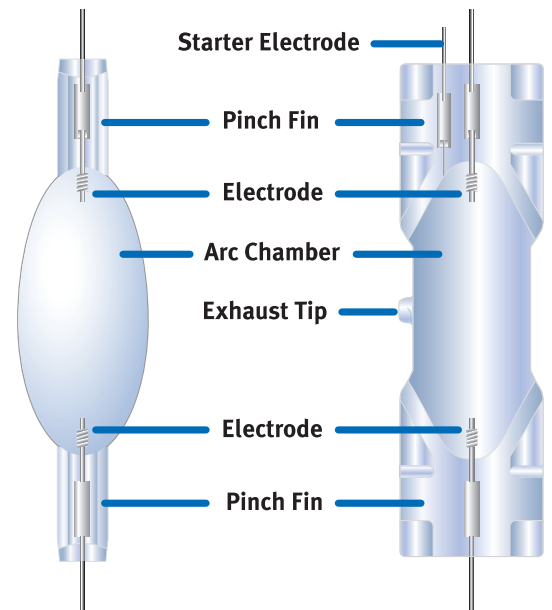

Additional Protection for your Metal Halide Lamps

Open Luminaire Rated HIPE lamps

Incorporating an internal shroud to prevent the outer envelope from shattering in the unlikely event of a lamp malfunction

- Arc tube surrounded by an internal shroud
- Continuous operation no shut off required
- Eliminates the need for a luminaire lens, to provide more light



GLASS GUARD®* fragment retention technology

Prevents a lamp from shattering if dropped or mishandled

- Broken and shattered lamps are completely retained within the lamps additional protective coating.
- Completely prevents glass contamination or injury from a broken lamp
- Protects personnel, products and profits
- Available for any elliptical lamp operating vertically



* GlassGuard is a registered trademark of Fotolec Technologies plc

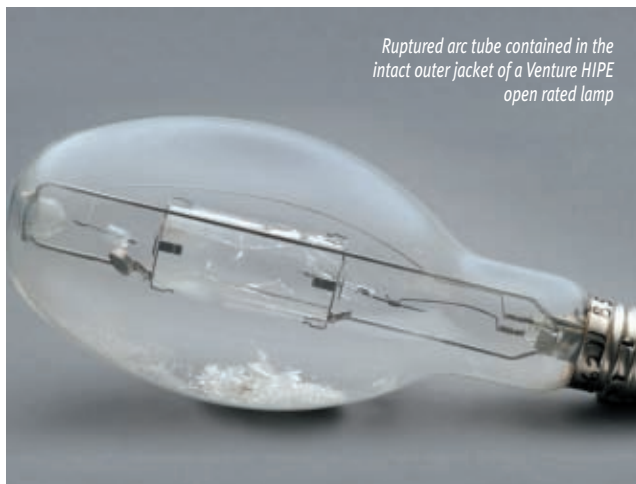

Ruptured arc tube contained in the intact outer jacket of a Venture HIPE open rated lamp

UV Shield® the solution to polycarbonate yellowing

Incorporating an impregnated quartz shroud to absorb ultraviolet light

- Prevents 'yellowing' of polycarbonate lenses
- Blocks up to 80% of damaging UV Light
- Can extend the life of the fitting lens up to 10 times



White-Lux - HPS Replacement Lamps

It's quick and simple to get rid of old, high-pressure sodium lighting – with White-Lux Plus Metal Halide lamps from Venture Lighting.

White-Lux Plus lamps can operate directly from existing HPS control gear. Even 'difficult' 70W HPS lamps with internal starters can be directly replaced, using a simple conversion kit.

So why put up with murky yellow-tinged sodium lighting when it's never been easier or more cost effective to switch – and enjoy the clean, fresh and natural white light of metal halide lamp technology!

- From the world leaders in metal halide technology
- Unique Venture Uni-Form formed body arc tube
- Faster warm-up and hot restart
- Increased efficiency
- Long life – up to 20,000 hours
- Better lamp-to-lamp consistency
- A full range of ratings from 50 to 400 watts
- A choice of tubular and elliptical designs
- Clear or coated outer jackets
- For use in open or enclosed fittings
- No thermal cut-out ballasts required
- Environmentally friendly UV shields available for fittings with poly-carbonate lenses

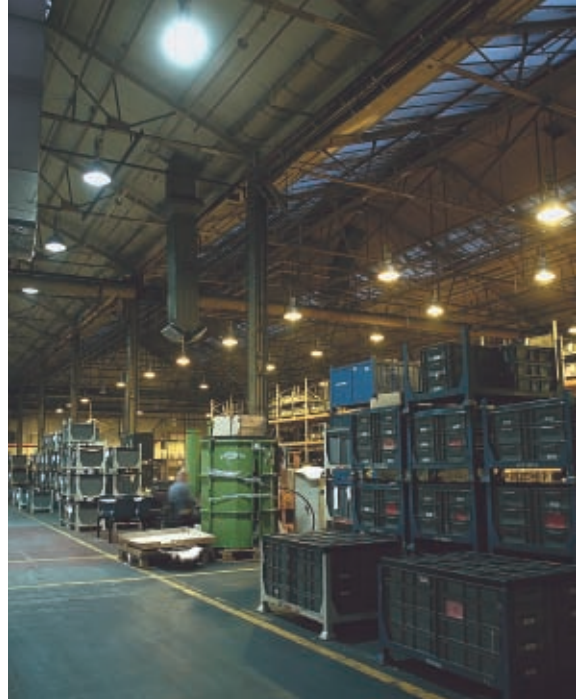

Open Rated Horizontal Tubular Lamps

Features:

Clear tubular lamps with UV Shield for Horizontal operation in open luminaires.

Applications:

For use in Low Bay luminaires for warehouses, retail sheds, showrooms and other commercial and industrial applications.

White-lux are direct replacements for HPS lamps.

Open Rated

Watts	Lamp Description	Product No.	Initial Lumens	Avg. Life Hours	UVShield	UNI-FORM [®] ARC TUBE TECHNOLOGY		Reactor Control Gear				
					CCT (K)	Warm-Up (Min)	Restrike (Min)	RA	Finish	Oper. Pos.	Fig.	Case Qty
200	HIPT 200W/H75/UVS/T52/PS/4K	00247	19000	15000	4000	2-3	3-5	68	Clear	HOR±75°	A	12
350	HIPT 350W/H75/UVS/T52/PS/4K	00248	33000	20000	4000	2-3	3-5	68	Clear	HOR±75°	B	12

Open Rated

Watts	Lamp Description	Product No.	Initial Lumens	Avg. Life Hours	UVShield	UNI-FORM [®] ARC TUBE TECHNOLOGY		Mercury Control Gear				
					CCT (K)	Warm-Up (Min)	Restrike (Min)	RA	Finish	Oper. Pos.	Fig.	Case Qty
250	HIPT 250W/H75/UVS/T52/PS/4K	00245	22000	12000	4000	2-3	3-5	68	Clear	HOR±75°	A	12
400	HIPT 400W/H75/UVS/T52/PS/4K	00246	38000	20000	4000	2-3	3-5	68	Clear	HOR±75°	B	12

Open Rated

White-Lux Tubular

Watts	Lamp Description	Product No.	Initial Lumens	Avg. Life Hours *	UVShield	UNI-FORM [®] ARC TUBE TECHNOLOGY		HPS Control Gear				
					CCT (K)	Warm-Up (Min)	Restrike (Min)	RA	Finish	Oper. Pos.	Fig.	Case Qty
250	HIPT 250W/H75/LU/UVS/T52/4K	00249	20000	12000	4000	2-3	3-5	68	Clear	HOR±75°	A	12
400	HIPT 400W/H75/LU/UVS/T52/4K	00250	36000	20000	4000	2-3	3-5	68	Clear	HOR±75°	B	12

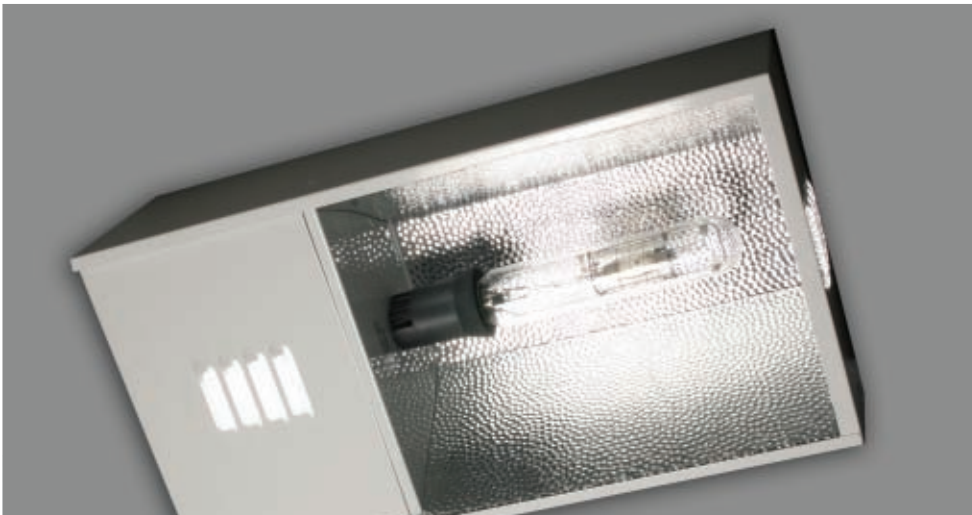

Some lamp descriptions include the 3 digit International Ra/CCT Code



T52

Dia. = 52mm
MOL = 211mm
LCL = 132mm
Base = E40



T52B

Dia. = 52mm
MOL = 285mm
LCL = 146mm
Base = E40

White-Lux® Plus

White-Lux® Plus metal halide lamps in 50,70, 100, 150, 250, 400, 600 and 1000 wattages offer increased lumen efficiency over existing White-Lux metal halide lamps. These lamps can be used to convert the harsh yellow light of sodium lamps in existing installations to clean white metal halide light.

They also provide the added benefit of a formed body arc tube for faster starting. White-Lux Plus metal halide lamps operate on standard HPS ballasts and ignitors.

Features:

- High lumen efficiency
- Long lamp life
- Enclosed and open fixture designs
- Uni-Form® formed body arc tube for faster starting
- UV Shield® option available (UVS)

Enclosed Rated

Watts	Lamp Description	Product No.	Initial Lumens	Avg. Life Hours	CCT (K)	UNI-FORM® ARC TUBE TECHNOLOGY		RA	Finish	HPS Control Gear		
						Warm-Up (Min)	Restrike (Min)			Oper. Pos.	Fig.	Case Qty
50	HIE 50W/U/LU/4K	67331	3400V	10000V	4000	1-2	1-2	68	Clear	U	A	12
70	HIE 70W/U/LU/4K	27373	5600V	15000V	4000	1-2	1-2	68	Clear	U	A	12
70	HIE 70W/C/U/LU/4K	63173	5300V	15000V	3700	1-2	1-2	70	Coated	U	A	12
70	HIE 70W/U/LU/3K	23660	5600V	15000V	3200	1-2	1-2	68	Clear	U	A	12
70	HIE 70W/C/U/LU/3K	96720	5300V	15000V	3200	1-2	1-2	70	Coated	U	A	12
100	HIE 100W/U/LU/4K	50340	9000V	15000V	4000	1-2	2-4	68	Clear	U	A	12
100	HIE 100W/C/U/LU/4K	19031	8500V	15000V	3700	1-2	2-4	70	Coated	U	A	12
100	HIE 100W/U/LU/3K	79457	9000V	15000V	3200	1-2	2-4	68	Clear	U	A	12
100	HIE 100W/C/U/LU/3K	45157	8500V	15000V	3200	1-2	2-4	70	Coated	U	A	12
150	HIE 150W/U/LU/4K	30544	14000V	15000V	4000	1-2	2-4	68	Clear	U	A	12
150	HIE 150W/C/U/LU/4K	40563	13300V	15000V	3700	1-2	2-4	70	Coated	U	A	12
150	HIE 150W/C/U/LU/3K	69876	13300V	15000V	3200	1-2	2-4	70	Coated	U	A	12

Open Rated

Watts	Lamp Description	Product No.	Initial Lumens	Avg. Life Hours	CCT (K)	UV Shield®		UNI-FORM® ARC TUBE TECHNOLOGY		HPS Control Gear		
						Warm-Up (Min)	Restrike (Min)	RA	Finish	Oper. Pos.	Fig.	Case Qty
70	HIPE 70W/C/U/LU/UVS/3K	52910	5000V	15000V	3200	1-2	2-4	70	Coated	U	B	12
70	HIPE 70W/C/V/LU/UVS/27K	48692	5000V	15000V	2700	1-2	2-4	70	Coated	V±15°	B	12
70	HIPE 70W/U/LU/UVS/4K	10002	5300V	15000V	4000	1-2	2-4	68	Clear	U	B	12
70	HIPE 70W/C/U/LU/UVS/4K	10003	5000V	15000V	3700	1-2	2-4	70	Coated	U	B	12
100	HIPE 100W/U/LU/UVS/3K	82539	8500V	15000V	3200	1-2	3-5	68	Clear	U	B	12
100	HIPE 100W/C/U/LU/UVS/3K	65850	8100V	15000V	3200	1-2	3-5	70	Coated	U	B	12
100	HIPE 100W/C/V/LU/UVS/27K	39468	8100V	15000V	2700	1-2	3-5	70	Coated	V±15°	B	12
100	HIPE 100W/U/LU/UVS/4K	10004	8500V	15000V	4000	1-2	3-5	68	Clear	U	B	12
100	HIPE 100W/C/U/LU/UVS/4K	10005	8100V	15000V	3700	1-2	3-5	70	Coated	U	B	12
100	HIPE 100W/U/LU/E90/UVS/4K	10050	8500V	15000V	4000	1-2	3-5	68	Clear	U	C	12
150	HIPE 150W/U/LU/UVS/3K	22822	13300V	15000V	3200	1-2	3-5	68	Clear	U	B	12
150	HIPE 150W/C/U/LU/UVS/3K	22833	12600V	15000V	3200	1-2	3-5	70	Coated	U	B	12
150	HIPE 150W/C/V/LU/UVS/27K	41700	12600V	15000V	2700	1-2	3-5	70	Coated	V±15°	B	12
150	HIPE 150W/U/LU/E90/UVS/4K	10051	13300V	15000V	4000	1-2	3-5	68	Clear	U	C	12
150	HIPE 150W/C/U/LU/E90/UVS/4K	10082	12600V	15000V	3700	1-2	3-5	70	Coated	U	C	12
150	HIPE 150W/U/LU/UVS/4K	10006	13300V	15000V	4000	1-2	3-5	68	Clear	U	B	12
150	HIPE 150W/C/U/LU/UVS/4K	10007	12600V	15000V	3700	1-2	3-5	70	Coated	U	B	12

Conversion Kit (Lamp and Ignitor)

Watts	Lamp Description	Product No.	Initial Lumens	Avg. Life Hours	CCT (K)	UV Shield®		UNI-FORM® ARC TUBE TECHNOLOGY		HPS Control Gear		
						Warm-Up (Min)	Restrike (Min)	RA	Finish	Oper. Pos.	Fig.	Case Qty
70	HIPE 70W/U/LU/UVS/4K	10101	5300V	15000V	4000	1-2	2-4	68	Clear	U	D	12
70	HIPE 70W/C/U/LU/UVS/4K	10102	5000V	15000V	3700	1-2	2-4	70	Coated	U	D	12

Some lamp descriptions include the 3 digit International Ra/CCT Code



A
E54

Dia. = 54mm
MOL = 141mm
LCL = 89mm
Base = E27

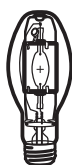

B
EX54

Dia. = 54mm
MOL = 141mm
LCL = 89mm
Base = E27

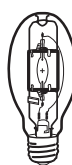

C
E90

Dia. = 90mm
MOL = 215mm
LCL = 131mm
Base = E40

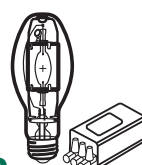

D
KIT

Dia. = 54mm
MOL = 141mm
LCL = 89mm
Base = E27

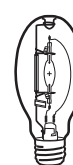

E
E90

Dia. = 90mm
MOL = 215mm
LCL = 131mm
Base = E40

10



White-Lux® Plus

Applications:

Floodlighting
Factories
Car Parks

Retail warehouses
Security lighting
Showrooms/Warehouses

For Tubular Open
Rated Lamps See
Page 13

Lamps

White-Lux®

Enclosed Rated

Watts	Lamp Description	Product No.	Initial Lumens	Avg. Life Hours	CCT (K)	Warm-Up (Min)	Restrike (Min)	RA	Finish	Oper. Pos.	Fig.	Case Qty
250	HIE 250W/V/LU/4K	31668	22000	20000	4000	2-3	3-5	68	Clear	V±15°	E	12
250	HIE 250W/C/V/LU/4K	56266	21000	20000	3700	2-3	3-5	70	Coated	V±15°	E	12
250	HIE 250W/C/H75/LU/4K	43634	20000	20000	3700	2-3	4-6	70	Coated	HOR±75°	E	12
400	HIE 400W/V/LU/4K	60112	44000	20000	4000	2-3	4-6	68	Clear	V±15°	F	6
400	HIE 400W/C/V/LU/4K	54695	42000	20000	3700	2-3	4-6	70	Coated	V±15°	F	6
400	HIE 400W/C/H75/LU/4K	68110	38000	20000	3700	2-3	5-8	70	Coated	HOR±75°	F	6
1000	HIE 1000W/V/LU/BT120/4K	00154	90000	8000	4000	2-3	10-15	68	Clear	V±15°	P	6

UNI-FORM®
ARC TUBE TECHNOLOGY

HPS Control Gear

Open Rated

Watts	Lamp Description	Product No.	Initial Lumens	Avg. Life Hours	CCT (K)	Warm-Up (Min)	Restrike (Min)	RA	Finish	Oper. Pos.	Fig.	Case Qty
250	HIPE 250W/HBU/LU/UVS/4K	10016	21000V	20000V	4000	2-3	4-6	68	Clear	V±15°	C	12
250	HIPE 250W/C/HBU/LU/UVS/4K	10076	20000V	20000V	3700	2-3	4-6	70	Coated	V±15°	C	12
250	HIPE 250W/C/H75/LU/UVS/4K	29486	20000	20000	3700	2-3	4-6	70	Coated	HOR±75°	C	12
400	HIPE 400W/V/LU/UVS/4K	10077	42000	20000	4000	2-3	5-8	68	Clear	V±15°	G	6
400	HIPE 400W/C/V/LU/UVS/4K	10043	40000	20000	3700	2-3	5-8	70	Coated	V±15°	G	6
400	HIPE 400W/C/H75/LU/UVS/4K	40511	38000	20000	3700	2-3	5-8	70	Clear	HOR±75°	G	6

UVShield

UNI-FORM®
ARC TUBE TECHNOLOGY

HPS Control Gear

Open Rated (High Output)

Watts	Lamp Description	Product No.	Initial Lumens	Avg. Life Hours	CCT (K)	Warm-Up (Min)	Restrike (Min)	RA	Finish	Oper. Pos.	Fig.	Case Qty
400	HIPE 400W/V/LU/UVS/HO/4K	54918	47000	20000	4000	2-3	5-8	68	Clear	V±15°	G	6
400	HIPE 400W/C/V/LU/UVS/HO/4K	42067	45000	20000	3700	2-3	5-8	70	Coated	V±15°	G	6

UVShield

UNI-FORM®
ARC TUBE TECHNOLOGY

HPS Control Gear

Enclosed Rated





Watts	Lamp Description	Product No.	Initial Lumens	Avg. Life Hours	CCT (K)	Warm-Up (Min)	Restrike (Min)	RA	Finish	Oper. Pos.	Fig.	Case Qty
70	HIT 70W/U/LU/4K	13742	5300V	15000V	4000	1-2	1-2	68	Clear	U	H	12
100	HIT 100W/U/LU/T38/4K	76738	9000V	15000V	4000	1-2	2-4	68	Clear	U	H	12
100	HIT 100W/U/LU/T46/4K	87368	9000V	15000V	4000	1-2	2-4	68	Clear	U	I	12
150	HIT 150W/U/LU/T38/4K	62272	14000V	15000V	4000	1-2	2-4	68	Clear	U	H	12
150	HIT 150W/U/LU/T46/4K	71144	14000V	15000V	4000	1-2	2-4	68	Clear	U	I	12
250	HIT 250W/U/LU/4K	48768	19000V	10000V	4000	3-5	5-10	68	Clear	U	J	12
250	HIT 250W/U/LU/5K	10855	16800V	10000V	5200	3-5	5-10	75	Clear	U	J	12
250	HIT 250W/H75/LU/4K	27965	20000	15000	4000	3-5	5-10	68	Clear	HOR±75°	N	12
400	HIT 400W/U/LU/4K	98748	36000V	20000V	4000	3-5	5-10	68	Clear	U	K	12
400	HIT 400W/U/LU/5K	21044	32000V	20000V	5200	3-5	5-10	75	Clear	U	K	12
400	HIT 400W/H75/LU/4K	43898	40000	15000	4000	3-5	5-10	68	Clear	HOR±75°	O	12
600	HIT 600W/U/LU/4K	54631	55000V	12000V	4000	3-5	5-10	68	Clear	BU±90°	L	6
1000	HIT 1000W/U/LU/4K	83265	90000V	8000V	4000	3-5	10-15	68	Clear	U	M	6
1000	HIT 1000W/U/LU/5K	00083	80000V	8000V	5000	3-5	10-15	68	Clear	U	M	6

White-Lux® Tubular

UNI-FORM®
ARC TUBE TECHNOLOGY

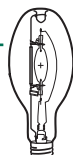
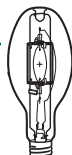
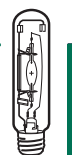
HPS Control Gear

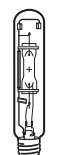
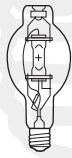
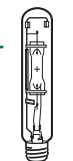
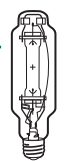
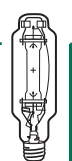
Some lamp descriptions include the 3 digit International Ra/CCT Code

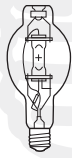
<p>E120 F</p> <p>Dia. = 120mm MOL = 296mm LCL = 182mm Base = E40</p> 	<p>E120 G</p> <p>Dia. = 120mm MOL = 296mm LCL = 182mm Base = E40</p> 	<p>T38 F</p> <p>Dia. = 38mm MOL = 156mm LCL = 182mm Base = E27</p> 	<p>T46 I</p> <p>Dia. = 46mm MOL = 211mm LCL = 132mm Base = E40</p> 	<p>T46 J</p> <p>Dia. = 46mm MOL = 225mm LCL = 146mm Base = E40</p> 	
<p>T46 K</p> <p>Dia. = 46mm MOL = 285mm LCL = 175mm Base = E40</p> 	<p>T76 F</p> <p>Dia. = 76mm MOL = 283mm LCL = 175mm Base = E40</p> 	<p>T76 M</p> <p>Dia. = 76mm MOL = 340mm LCL = 220mm Base = E40</p> 	<p>T46 N</p> <p>Dia. = 46mm MOL = 225mm LCL = 146mm Base = E40</p> 	<p>T46 O</p> <p>Dia. = 46mm MOL = 285mm LCL = 175mm Base = E40</p> 	<p>BT120 P</p> <p>Dia. = 120mm MOL = 296mm LCL = 182mm Base = E40</p> 

Energy Saving Lamps -

With Achievable Savings of Almost 50%

There is now a rapidly growing demand for ever more energy efficient lighting systems to help the environment.

Venture Lighting is leading the way worldwide in developing innovative new energy efficient lighting products to help reduce overall energy usage costs but without compromising on lighting quality.

Now, Venture's pulse start metal halide lighting systems are widely regarded as the most advanced available. They offer more light than conventional systems, excellent colour uniformity, longer life and – most important of all – significant energy savings



Energy Saving Uni-Form® Pulse Start

The 200 and 350 watt Uni-Form® Energy Saving lamps are designed to replace standard 250 and 400 watt metal halide lamps. These lamps operate on reactor/ignitor ballast systems specifically designed to realise the best performance from these light sources, including longer life and better lumen maintenance.

Features:

- Higher lumens vs. standard designs
- System savings, up to 50 watts
- Longer life (up to 20,000 hours)
- Faster warm-up and hot restrike
- Improved lumen maintenance
- Reduced colour shift
- Better cold temperature starting (-40°C)
- UV Shield® option available (UVS)

Applications:

- Petrol station canopies
- Industrial high bay and low bay fittings
- Larger retail areas

Enclosed Rated

Watts	Lamp Description	Product No.	Initial Lumens	Avg. Life Hours	CCT (K)	Warm-Up (Min)	Restrike (Min)	RA	Finish	Oper. Pos.	Fig.	Case Qty
200	HIE 200W/U/PS/740	88247	21000V	15000V	4000	1-2	2-4	68	Clear	U	A	12
200	HIE 200W/C/U/PS/737	10058	20000V	15000V	3700	1-2	2-4	70	Coated	U	A	12
350	HIE 350W/V/PS/740	20138	37000	20000+	4000	2-3	4-6	68	Clear	V±15°	C	6
350	HIE 350W/C/V/PS/737	10056	35000	20000+	3700	2-3	4-6	70	Coated	V±15°	C	6
350	HIE 350W/H75/PS/740	96307	33000	15000	4000	2-3	4-6	68	Clear	HOR±75°	C	6

UNI-FORM®
ARC TUBE TECHNOLOGY

Reactor Control Gear

Open Rated

Watts	Lamp Description	Product No.	Initial Lumens	Avg. Life Hours	CCT (K)	Warm-Up (Min)	Restrike (Min)	RA	Finish	Oper. Pos.	Fig.	Case Qty
200	HIPE 200W/V/UVS/PS/740	10067	20000	15000	4000	1-2	3-5	68	Clear	V±15°	B	12
350	HIPE 350W/V/UVS/PS/740	10068	35000	20000+	4000	2-3	5-8	68	Clear	V±15°	D	6

UVShield®

UNI-FORM®
ARC TUBE TECHNOLOGY

Reactor Control Gear

Open Rated

Watts	Lamp Description	Product No.	Initial Lumens	Avg. Life Hours	CCT (K)	Warm-Up (Min)	Restrike (Min)	RA	Finish	Oper. Pos.	Fig.	Case Qty
200	HIPE 200W/C/V/UVS/PS/737	10059	19000	15000	3700	1-2	3-5	70	Coated	V±15°	B	12
350	HIPE 350W/C/V/UVS/PS/737	10057	33000	20000+	3700	2-3	5-8	70	Coated	V±15°	D	6

UVShield®

UNI-FORM®
ARC TUBE TECHNOLOGY

Reactor Control Gear

NOTE: A life rating of 20,000+ hours means that 70% of the lamps initially installed will still be operating after 20,000 hours.

Enclosed Rated

Watts	Lamp Description	Product No.	Initial Lumens	Avg. Life Hours	CCT (K)	Warm-Up (Min)	Restrike (Min)	RA	Finish	Oper. Pos.	Fig.	Case Qty
200	HIT 200W/H75/PS/4K	00285	20000	15000	4000	2-3	5-8	68	Clear	HOR±75°	H	12
350	HIT 350W/H75/PS/4K	00283	33000	20000	4000	2-3	5-8	68	Clear	HOR±75°	I	12

UNI-FORM®
ARC TUBE TECHNOLOGY

Reactor Control Gear

Open Rated

Watts	Lamp Description	Product No.	Initial Lumens	Avg. Life Hours	CCT (K)	Warm-Up (Min)	Restrike (Min)	RA	Finish	Oper. Pos.	Fig.	Case Qty
320	HIPE 320W/C/V/UVS/EL/PS/737	40904	30000	20000+	3700	2-3	5-8	70	Coated	V±15°	D	6
320	HIPE 320W/V/UVS/EL/PS/740	49786	32000	20000+	4000	2-3	5-8	70	Clear	V±15°	D	6

UVShield®

UNI-FORM®
ARC TUBE TECHNOLOGY

Ventronic®

Some lamp descriptions include the 3 digit International Ra/CCT Code



A
E90
Dia. = 90mm
MOL = 215mm
LCL = 131mm
Base = E40

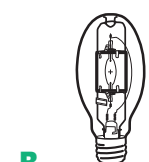

B
E90
Dia. = 90mm
MOL = 215mm
LCL = 131mm
Base = E40

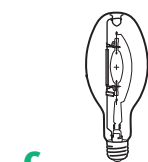

C
E120
Dia. = 120mm
MOL = 2965mm
LCL = 182mm
Base = E40

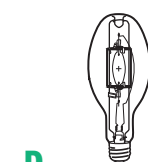

D
E120
Dia. = 120mm
MOL = 296mm
LCL = 182mm
Base = E40



F
T46
Dia. = 46mm
MOL = 225mm
LCL = 146mm
Base = E40



I
T46
Dia. = 46mm
MOL = 285mm
LCL = 175mm
Base = E40

Uni-Form® Pulse Start High Performance

Lamps

Uni-Form® Pulse Start

Uni-Form® 250, 400 and 450 Watt High Performance lamps are designed to out perform standard pinch body 250W and 400W metal halide lamps. These lamps operate on reactor/ignitor ballast systems specifically designed to realise the best performance from these light sources, including longer life and better lumen maintenance. 450W lamps operate on HPS Control Gear

Features:

- Higher lumens vs. standard designs
- System savings, up to 50 watts
- Longer life (20,000+hours)
- Faster warm-up and hot restrike
- Improved lumen maintenance
- Reduced colour shift
- Better cold temperature starting (-40°C)
- UV Shield® option available (UVS)
- Impact Guard™ coating available for base-up application- call for details

Enclosed Rated

Watts	Lamp Description	Product No.	Initial Lumens	Avg. Life Hours	CCT (K)	Warm-Up (Min)	Restrike (Min)	RA	Finish	Oper. Pos.	Fig.	Case Qty
250	HIE 250W/V/PS/740	18980	25000	15000	4000	2-3	3-5	68	Clear	V±15°	A	12
250	HIE 250W/C/V/PS/737	61513	23800	15000	3700	2-3	3-5	70	Coated	V±15°	A	12
250	HIE 250W/C/H75/PS/737	91947	20000	15000	3700	2-3	3-5	70	Coated	HOR±75°	A	12
400	HIE 400W/V/PS/740	92008	44000	20000+	4000	2-3	4-6	68	Clear	V±15°	C	6
400	HIE 400W/C/V/PS/737	60444	42000	20000+	3700	2-3	4-6	70	Coated	V±15°	C	6
400	HIE 400W/C/H75/PS/737	68592	40000	20000	3700	2-3	4-6	70	Coated	HOR±75°	C	6

UNI-FORM®
ARC TUBE TECHNOLOGY

Mercury Control Gear

Open Rated

Watts	Lamp Description	Product No.	Initial Lumens	Avg. Life Hours	CCT (K)	Warm-Up (Min)	Restrike (Min)	RA	Finish	Oper. Pos.	Fig.	Case Qty
250	HIPE 250W/V/UVS/PS/740	10008	23800	15000	4000	2-3	4-6	68	Clear	V±15°	B	12
400	HIPE 400W/V/UVS/PS/740	10015	41000	20000+	4000	2-3	5-8	68	Clear	V±15°	D	6

UV Shield®

UNI-FORM®
ARC TUBE TECHNOLOGY

Mercury Control Gear

Open Rated

Watts	Lamp Description	Product No.	Initial Lumens	Avg. Life Hours	CCT (K)	Warm-Up (Min)	Restrike (Min)	RA	Finish	Oper. Pos.	Fig.	Case Qty
450	HIPE 450W/V/UVS/PS/740	47224	47000	20000+	4000	2-3	5-8	68	Clear	V±15°	D	6

UV Shield®

UNI-FORM®
ARC TUBE TECHNOLOGY

HPS Control Gear

Open Rated

Watts	Lamp Description	Product No.	Initial Lumens	Avg. Life Hours	CCT (K)	Warm-Up (Min)	Restrike (Min)	RA	Finish	Oper. Pos.	Fig.	Case Qty
250	HIPE 250W/C/V/UVS/PS/737	10014	23000	15000	3700	2-3	4-6	70	Coated	V±15°	B	12
400	HIPE 400W/C/V/UVS/PS/737	10041	40000	20000+	3700	2-3	5-8	70	Coated	V±15°	D	6

UV Shield®

UNI-FORM®
ARC TUBE TECHNOLOGY

Mercury Control Gear

Open Rated

Watts	Lamp Description	Product No.	Initial Lumens	Avg. Life Hours	CCT (K)	Warm-Up (Min)	Restrike (Min)	RA	Finish	Oper. Pos.	Fig.	Case Qty
450	HIPE 450W/C/V/UVS/PS/737	74517	45000	20000+	3700	2-3	5-8	70	Coated	V±15°	D	6

UV Shield®

UNI-FORM®
ARC TUBE TECHNOLOGY

HPS Control Gear

Enclosed Rated

Watts	Lamp Description	Product No.	Initial Lumens	Avg. Life Hours	CCT (K)	Warm-Up (Min)	Restrike (Min)	RA	Finish	Oper. Pos.	Fig.	Case Qty
250	HIT 250W/H75/PS/740	26240	22000	15000	4000	2-3	5-8	68	Clear	HOR±75°	E	12
400	HIT 400W/H75/PS/740	56842	42000	20000	4000	2-3	5-8	68	Clear	HOR±75°	F	12

UNI-FORM®
ARC TUBE TECHNOLOGY

Mercury Control Gear

Some lamp descriptions include the 3 digit International Ra/CCT Code

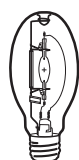

A
E90

Dia. = 90mm
MOL = 125mm
LCL = 131mm
Base = E40

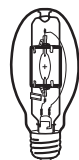

B
E90

Dia. = 90mm
MOL = 215mm
LCL = 131mm
Base = E40

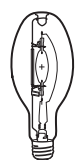

C
E120

Dia. = 120mm
MOL = 296mm
LCL = 182mm
Base = E40

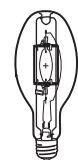

D
E120

Dia. = 120mm
MOL = 296mm
LCL = 182mm
Base = E40



E
T46

Dia. = 46mm
MOL = 225mm
LCL = 146mm
Base = E40



F
T46

Dia. = 46mm
MOL = 285mm
LCL = 175mm
Base = E40

14



Tubular Metal Halide

Features:

- Full range of wattages
- Unique tubular lamps
- Compact light source
- Choice of colour temperatures

Applications:

- Floodlighting
- Sports lighting
- General lighting
- Street lighting

For Tubular Open Rated Lamps See Page 13

Lamps

Tubular Metal Halide

Enclosed Rated

Pulse Start Tubular

UNI-FORM[®]
ARC TUBE TECHNOLOGY

Reactor Control Gear

Watts	Lamp Description	Product No.	Initial Lumens	Avg. Life Hours	CCT (K)	Warm-Up (Min)	Restrike (Min)	RA	Finish	Oper. Pos.	Fig.	Case Qty
200	HIT 200W/U/H75/PS/4K	00285	20000	15000	4000	2-3	5-8	68	Clear	HOR±75°	H	12
250	HIT 250W/U/H75/PS/740	26240	22000	15000	4000	2-3	5-8	68	Clear	HOR±75°	H	12
350	HIT 350W/U/H75/PS/4K	00283	33000	20000	4000	2-3	5-8	68	Clear	HOR±75°	I	12
400	HIT 400W/U/H75/PS/740	56842	40000	20000	4000	2-3	5-8	68	Clear	HOR±75°	I	12

Enclosed Rated

White-Lux Plus Tubular

UNI-FORM[®]
ARC TUBE TECHNOLOGY

HPS Control Gear

Watts	Lamp Description	Product No.	Initial Lumens	Avg. Life Hours	CCT (K)	Warm-Up (Min)	Restrike (Min)	RA	Finish	Oper. Pos.	Fig.	Case Qty
70	HIT 70W/U/LU/4K	13742	5300V	15000V	4000	1-2	1-2	68	Clear	U	A	12
100	HIT 100W/U/LU/T38/4K	76738	9000V	15000V	4000	1-2	2-4	68	Clear	U	A	12
100	HIT 100W/U/LU/T46/4K	87368	9000V	15000V	4000	1-2	2-4	68	Clear	U	B	12
150	HIT 150W/U/LU/T38/4K	62272	14000V	15000V	4000	1-2	2-4	68	Clear	U	A	12
150	HIT 150W/U/LU/T46/4K	71144	14000V	15000V	4000	1-2	2-4	68	Clear	U	B	12

Enclosed Rated

White-Lux Tubular

HPS Control Gear

Watts	Lamp Description	Product No.	Initial Lumens	Avg. Life Hours	CCT (K)	Warm-Up (Min)	Restrike (Min)	RA	Finish	Oper. Pos.	Fig.	Case Qty
250	HIT 250W/U/LU/4K	48768	19000V	10000V	4000	3-5	5-10	68	Clear	U	C	12
250	HIT 250W/U/LU/5K	10855	16800V	10000V	5200	3-5	5-10	75	Clear	U	C	12
250	HIT 250W/U/H75/LU/4K	27965	19000	15000	4000	3-5	5-10	68	Clear	HOR±75°	H	12
400	HIT 400W/U/LU/4K	98748	36000V	15000V	4000	3-5	5-10	68	Clear	U	D	12
400	HIT 400W/U/LU/5K	21044	32000V	15000V	5200	3-5	5-10	75	Clear	U	D	12
400	HIT 400W/U/H75/LU/4K	43898	40000	15000	4000	3-5	5-10	68	Clear	HOR±75°	I	12
600	HIT 600W/U/LU/4K	54631	55000V	12000V	4000	3-5	5-10	68	Clear	U	E	6
1000	HIT 1000W/U/LU/4K	83265	90000V	8000V	4000	3-5	10-15	68	Clear	U	F	6
1000	HIT 1000W/U/LU/5K	00083	80000V	8000V	5000	3-5	10-15	68	Clear	U	F	6

Enclosed Rated

Euro Tubular

Mercury Control Gear

Watts	Lamp Description	Product No.	Initial Lumens	Avg. Life Hours	CCT (K)	Warm-Up (Min)	Restrike (Min)	RA	Finish	Oper. Pos.	Fig.	Case Qty
250	HIT 250W/U/EURO/4K	33950	21000V	10000V	4000	3-5	5-10	68	Clear	U	C	12
250	HIT 250W/HOR/EURO/4K	57712	23000	10000	4000	3-5	5-10	68	Clear	HOR±45°	C1	12
250	HIT 250W/U/EURO/5K	00033	19000V	7500V	5000	3-5	5-10	68	Clear	U	C	12
400	HIT 400W/U/EURO/5K	00034	32000V	15000V	5000	3-5	5-10	68	Clear	U	D	12
400	HIT 400W/U/EURO/4K	25830	36000V	15000V	4000	3-5	10-15	68	Clear	U	D	12
400	HIT 400W/HOR/EURO/4K	88410	40000	15000	4000	3-5	10-15	68	Clear	HOR±45°	D1	12

Enclosed Rated

Tubular





Reactor Control Gear

Watts	Lamp Description	Lamp Current	Product No.	Initial Lumens	Avg. Life Hours	CCT (K)	Warm-Up (Min)	Restrike (Min)	RA	Finish	Oper. Pos.	Fig.	Case Qty
1000	HIT 1000W/U/EURO/4K	Note ①	00008	90000V	8000V	4000	3-5	10-15	68	Clear	U	F	6
1000	HIT 1000W/U/EURO/5K	Note ①	00282	80000V	8000V	5000	3-5	10-15	68	Clear	U	F	6
2000	HIT 2000W/U/4K	Note ①	00066	230000V	5000V	4000	3-5	10-15	68	Clear	U	G	6
2000	HIT 2000W/U/230V/45K	Note ①	00067	185000V	5000V	4500	3-5	10-15	68	Clear	U	G	6

Some lamp descriptions include the 3 digit International Ra/CCT Code

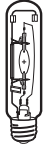
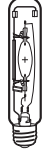
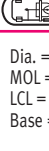
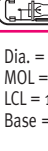
Notes

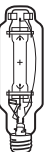
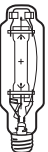
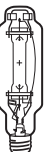
Note ① Ignitor can be supplied with lamp

<p>A T38 Dia. = 38mm MOL = 156mm LCL = 102mm Base = E27</p> 	<p>B T46 Dia. = 46mm MOL = 211mm LCL = 132mm Base = E40</p> 	<p>C T46 Dia. = 46mm MOL = 225mm LCL = 146mm Base = E40</p> 	<p>D T46 Dia. = 46mm MOL = 225mm LCL = 146mm Base = E40PO</p> 	<p>D T46 Dia. = 46mm MOL = 285mm LCL = 175mm Base = E40</p> 	<p>D1 T46 Dia. = 46mm MOL = 285mm LCL = 175mm Base = E40PO</p> 
<p>E T76 Dia. = 76mm MOL = 283mm LCL = 175mm Base = E40</p> 	<p>F T76 Dia. = 76mm MOL = 340mm LCL = 220mm Base = E40</p> 	<p>G T100 Dia. = 100mm MOL = 420mm LCL = 220mm Base = E40</p> 	<p>H T46 Dia. = 46mm MOL = 225mm LCL = 146mm Base = E40</p> 	<p>I T46 Dia. = 46mm MOL = 285mm LCL = 175mm Base = E40</p> 	

15

Euro Metal Halide

Euro Lamps make up a range of metal halide lamps suitable for mercury ballasts with either 600-900 volt 2-wire parallel ignitors, or 3000-4500 volt ignitors. The 125W Mercury Retrofit lamp operates on a mercury ballast with an 1800-2500 volt ignitor.

Features:

- Operates on mercury ballast with standard metal halide ignitor
- Vertical and horizontal lamps provide high performance and long life
- Tubular and elliptical design
- Clear and coated bulb finishes

Applications:

Petrol station canopies
Industrial high bay and low bay fittings
Larger retail areas

Enclosed Rated 125W Mercury Retrofit

UNI-FORM[®]
ARC TUBE TECHNOLOGY

Mercury Control Gear

Watts	Lamp Description	Product No.	Initial Lumens	Avg. Life Hours	CCT (K)	Warm-Up (Min)	Restrike (Min)	RA	Finish	Oper. Pos.	Fig.	Case Qty
125	HIE 125W/C/HBU/4K	97765	12000V	12000V	3700	1-2	2-4	70	Coated	BU±90°	A	12
125	HIE 125W/C/HBD/4K	59372	12000V	12000V	3700	1-2	2-4	70	Coated	BD±90°	A	12

Enclosed Rated

Mercury Control Gear

Watts	Lamp Description	Product No.	Initial Lumens	Avg. Life Hours	CCT (K)	Warm-Up (Min)	Restrike (Min)	RA	Finish	Oper. Pos.	Fig.	Case Qty
175	HIE 175W/U/E54/EURO/4K	84971	14000V	10000V	4000	3-5	5-10	68	Clear	U	B	12
175	HIE 175W/C/U/E54/EURO/4K	24729	13300V	10000V	3700	3-5	5-10	70	Coated	U	B	12
175	HIE 175W/U/EURO/4K	36279	14000V	10000V	4000	3-5	5-10	68	Clear	U	C	12
175	HIE 175W/C/U/EURO/4K	40698	13300V	10000V	3700	3-5	5-10	70	Coated	U	C	12
250	HIE 250W/BU/EURO/4K	81203	23000V	10000V	4000	2-4	5-10	68	Clear	BU±15°	C	12
250	HIE 250W/C/BU/EURO/4K	81202	22000V	10000V	3700	2-4	5-10	70	Coated	BU±15°	C	12
250	HIE 250W/U/EURO/4K	88246	21000V	10000V	4000	3-5	5-10	68	Clear	U	C	12
250	HIE 250W/C/U/EURO/4K	21303	20000V	10000V	3700	3-5	5-10	70	Coated	U	C	12

Enclosed Rated

Tubular

Mercury Control Gear

Watts	Lamp Description	Product No.	Initial Lumens	Avg. Life Hours	CCT (K)	Warm-Up (Min)	Restrike (Min)	RA	Finish	Oper. Pos.	Fig.	Case Qty
250	HIT 250W/U/EURO/4K	33950	21000V	10000V	4000	3-5	5-10	68	Clear	U	D	12
250	HIT 250W/U/EURO/5K	00033	19000V	7500V	5000	3-5	5-10	75	Clear	U	D	12
250	HIT 250W/HOR/EURO/4K	57712	23000	10000H	4000H	3-5	5-10	68	Clear	HOR±45°	D1	12

Some lamp descriptions include the 3 digit International Ra/CCT Code



A
E54

Dia. = 54mm
MOL = 141mm
LCL = 89mm
Base = E27

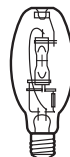

B
E54

Dia. = 54mm
MOL = 141mm
LCL = 89mm
Base = E27

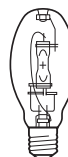

C
E90

Dia. = 90mm
MOL = 215mm
LCL = 131mm
Base = E40



D
T46

Dia. = 46mm
MOL = 225mm
LCL = 146mm
Base = E40

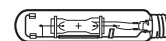

D1
T46

Dia. = 46mm
MOL = 225mm
LCL = 146mm
Base = E40PO

Euro Metal Halide

Enclosed Rated

Watts	Lamp Description	Product No.	Initial Lumens	Avg. Life Hours	CCT (K)	Warm-Up (Min)	Restrike (Min)	RA	Finish	Oper. Pos.	Fig.	Case Qty
400	HIE 400W/BU/EURO/4K	33544	40000	15000	4000	3-5	10-15	68	Clear	BU±15°	B	6
400	HIE 400W/C/BU/EURO/4K	31545	38000	15000	3700	3-5	10-15	70	Coated	BU±15°	B	6
400	HIE 400W/C/HOR/EURO/4K	63958	38000	15000	3700	3-5	10-15	70	Coated	HOR±45°	B1	6
400	HIE 400W/U/EURO/4K	20137	36000V	15000V	4000	3-5	8-12	68	Clear	U	B	6
400	HIE 400W/C/U/E90/EURO/4K*	58122	34000V	15000V	3700	3-5	8-12	70	Coated	U	A	12
400	HIE 400W/C/U/EURO/4K	88787	34000V	15000V	3700	3-5	8-12	70	Coated	U	B	6

* Reduced jacket

Mercury Control Gear

Open Rated

Watts	Lamp Description	Product No.	Initial Lumens	Avg. Life Hours	CCT (K)	Warm-Up (Min)	Restrike (Min)	RA	Finish	Oper. Pos.	Fig.	Case Qty
400	HIPE 400W/BU/EURO/4K	99441	38000	15000	4000	3-5	10-15	68	Clear	BU±15°	D	6
400	HIPE 400W/C/BU/EURO/4K	94102	36000	15000	3700	3-5	10-15	70	Coated	BU±15°	D	6

Mercury Control Gear

Enclosed Rated

Tubular

Watts	Lamp Description	Product No.	Initial Lumens	Avg. Life Hours	CCT (K)	Warm-Up (Min)	Restrike (Min)	RA	Finish	Oper. Pos.	Fig.	Case Qty
400	HIT 400W/U/EURO/4K	25830	36000V	15000V	4000	3-5	10-15	68	Clear	U	C	12
400	HIT 400W/U/EURO/5K	00034	32000V	15000V	5000	3-5	10-15	75	Clear	U	C	12
400	HIT 400W/HOR/EURO/4K	88410	40000	15000	4000	3-5	10-15	68	Clear	HOR±45°	C1	12

Mercury Control Gear

Enclosed Rated

Tubular

Watts	Lamp Description	Note	Lamp Current	Product No.	Initial Lumens	Avg. Life Hours	CCT (K)	Warm-Up (Min)	Restrike (Min)	RA	Finish	Oper. Pos.	Fig.	Case Qty
1000	HIT1000W/U/EURO/4K	Note ①	8.2	00008	90000V	8000V	4000	3-5	10-15	68	Clear	U	E	6
1000	HIT1000W/U/EURO/5K	Note ①	8.2	00282	80000V	8000V	5000	3-5	10-15	68	Clear	U	E	6
2000	HIT 2000W/U/4K	Note ①	8.8	00066	230000V	5000V	4000	3-5	10-15	68	Clear	U	F	6
2000	HIT 2000W/U/230V/45K	Note ①	16.5	00067	185000V	5000V	4500	3-5	10-15	68	Clear	U	F	6

Reactor Control Gear

Some lamp descriptions include the 3 digit International Ra/CCT Code

Notes
Note ① Ignitor can be supplied with lamp

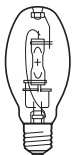

A
E90
Dia. = 90mm
MOL = 215mm
LCL = 131mm
Base = E40

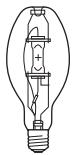

B
E120
Dia. = 120mm
MOL = 296mm
LCL = 182mm
Base = E40

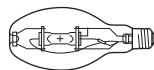

B1
E120
Dia. = 120mm
MOL = 296mm
LCL = 182mm
Base = E40PO



C
T46
Dia. = 46mm
MOL = 285mm
LCL = 175mm
Base = E40

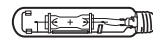

C1
T46
Dia. = 46mm
MOL = 285mm
LCL = 175mm
Base = E40PO

D
BT120
Dia. = 120mm
MOL = 296mm
LCL = 182mm
Base = E40

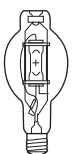

E
T76
Dia. = 76mm
MOL = 340mm
LCL = 220mm
Base = E40

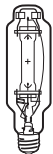

F
T100
Dia. = 100mm
MOL = 420mm
LCL = 220mm
Base = E40

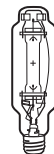

Natural White Full Spectrum

New *Natural White* lamps offer light output in all parts of the visual spectrum to provide better colour than ceramic metal halide lamps.

With *Natural White* lamps blues are true blue and reds are more vibrant; whites are whiter and skin tones look like they're under sunlight.

- More consistent lamp to lamp colour
- Light output in all parts of the visual spectrum
- Excellent colour uniformity and stability for the life of the lamp
- Provides better colour than ceramic metal halide
- Ideal for daylight harvesting applications
- Lamps feature superior Uni-Form® pulse start technology



Ceramic Metal Halide 4000K - 90 CRI



Uni-Form Natural White™ 5000K - 90+ CRI



Compact Fluorescent 3500K - 80 CRI



Natural White

Features:

Lamps with improved Colour Rendering Index (Ra) for high bay luminaires without protective cover glasses.

Applications:

- Retail stores or commercial and industrial applications requiring excellent colour rendering and colour matching.
- Museums, Art Galleries.

Open Rated

Watts	Lamp Description	Natural White™			UVShield®		UNI-FORM® ARC TUBE TECHNOLOGY		Finish	Oper. Pos.	Fig.	Case Qty
		Product No.	Initial Lumens Note ①	Avg. Life Hours	CCT (K)	Warm-Up (Min)	Restrike (Min)	RA				
35	HIT 35W/G12/UVS/950	67520	2200	10000V	5000	1-2	2-4	90+	Clear	U	C	25
150	HIT 150w/G12/UVS/950	15897	11000	10000V	5000	1-2	2-4	90+	Clear	U	B	25
150	HIPE 150w/C/U/950	39542	10400	15000V	5000	1-2	2-4	90+	Coated	U	D	12
225	HIPE 225W/BU/UVS/PS/950 Note ③	22994	21000	20000+	5000	2-3	4-6	90+	Clear	BU±15°	E	12
310	HIPE 310W/BU/UVS/PS/950 Note ④	58216	28500	20000+	5000	2-3	5-8	90+	Clear	BU±15°	A	6
365	HIPE 365W/C/V/UVS/PS/950 Note ②	53613	32100	20000+	5000	2-3	5-8	90+	Coated	V±15°	A	6

Some lamp descriptions include the 3 digit International Ra/CCT Code

Notes

- Note ① Scotopically Enhanced Task Lumens (S/P) 0.78
 Note ② Lamp operates at 365W on 400W Mercury ballast
 Note ③ Lamp operates on 250W Mercury ballast
 Note ④ Lamp operates on 350W ballast



A
E120
Dia. = 120mm
MOL = 296mm
LCL = 182mm
Base = E40

B
G12
Dia. = 23mm
MOL = 110mm
LCL = 56mm
Base = G12

C
G12
Dia. = 19mm
MOL = 90mm
LCL = 56mm
Base = G12

D
E54
Dia. = 54mm
MOL = 141mm
LCL = 89mm
Base = E27

E
E90
Dia. = 90mm
MOL = 215mm
LCL = 131mm
Base = E40

Ceramic Master-PLUS Metal Halide

Ceramic Master-PLUS Metal Halide lamps from Venture offer an unbeatable combination of performance and reliability, as you'd expect from the world's leading name in Metal Halide technology.

Features:

- Excellent light quality
- Exceptional colour rendering and consistency
- Increased lamp life
- Lower maintenance requirements
- Reduced heat output
- Significantly less power consumption than halogen equivalents
- Ideal for use with quality interior décors

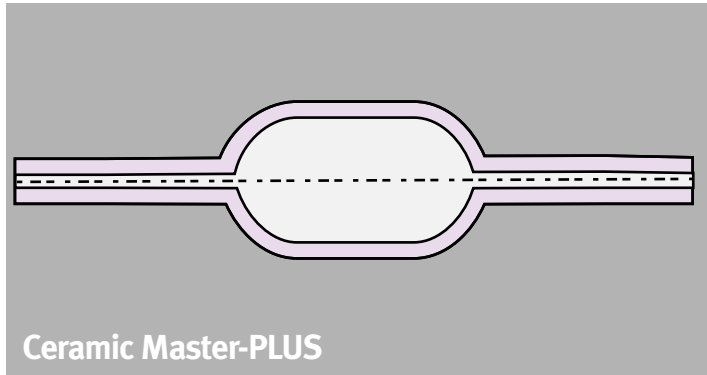

Ceramic Master-PLUS

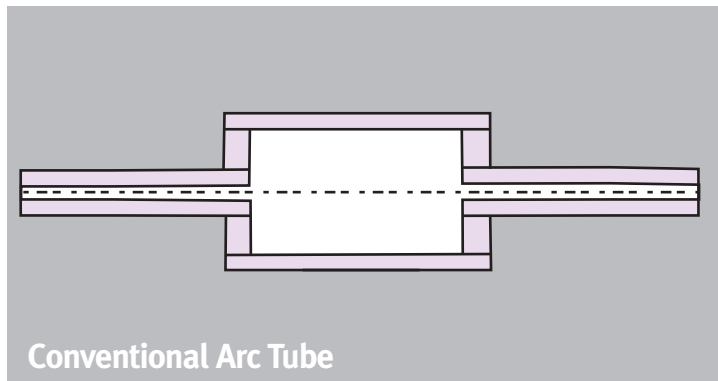

Conventional Arc Tube

Venture Ceramic Master-PLUS lamps use the latest in ceramic arc tube design. Our slip cast arc tube provides excellent reliability due to its factory formed construction. The single piece arc tube with contours similar to Venture **UNIFORM** lamps offers better colour control, higher Lumens and longer life

Energy Efficient

Venture Ceramic lamps are highly energy efficient and offer truly exceptional performance, delivering up to 100 lumens per watt. They therefore consume considerably less energy and generate less heat than a halogen equivalent. Maintenance requirements are reduced too, as the lamps are both robust and reliable and offer a life expectancy of up to 18,000 hours.

Excellent Light & Colour

The quality and consistency of light generated by Venture Metal Halide lamps has always been at the forefront of our design technology. The Venture Ceramic Master-PLUS range offers a clean white light and excellent colour rendering, making it ideal for display use and for accentuating quality interiors and décors. Colours, features and textures really stand out.

Lamp-to-lamp colour uniformity is comparable to Venture **UNIFORM** lamps, so the effect you want is never lost.

Ceramic Master-PLUS Metal Halide

Ceramic Lamp G8.5

Watts	Lamp Description	Product No.	Initial Lumens	Avg. Life Hours	CCT (K)	RA	Burn Pos.	Fig	Ctn. Qty
20W	CM-PLUS TC 20W/U/UVS/G8.5/830	00354	1800	9000	3000	80+	U	A	12
20W	CM-PLUS TC 20W/U/UVS/G8.5/942	00355	1800	9000	4200	90+	U	A	12
35W	CM-PLUS TC 35W/U/UVS/G8.5/830	00356	3400	12000	3000	80+	U	A	12
35W	CM-PLUS TC 35W/U/UVS/G8.5/942	00357	3300	12000	4200	90+	U	A	12
70W	CM-PLUS TC 70W/U/UVS/G8.5/830	00358	7000	12000	3000	80+	U	A	12
70W	CM-PLUS TC 70W/U/UVS/G8.5/942	00359	6600	12000	4200	90+	U	A	12

Ceramic Lamp G12

Watts	Lamp Description	Product No.	Initial Lumens	Avg. Life Hours	CCT (K)	RA	Burn Pos.	Fig	Ctn. Qty
20W	CM-PLUS T 20W/U/UVS/G12/830	00360	1800	10000	3000	80+	U	B	12
20W	CM-PLUS T 20W/U/UVS/G12/942	00361	1650	10000	4200	90+	U	B	12
35W	CM-PLUS T 35W/U/UVS/G12/830	00362	3400	12000	3000	80+	U	B	12
35W	CM-PLUS T 35W/U/UVS/G12/942	00363	3300	12000	4200	90+	U	B	12
70W	CM-PLUS T 70W/U/UVS/G12/830	00364	7000	12000	3000	80+	U	C	12
70W	CM-PLUS T 70W/U/UVS/G12/942	00365	6600	12000	4200	90+	U	C	12
100W	CM-PLUS T 100W/U/UVS/G12/830	00366	9500	12000	3000	80+	U	D	12
100W	CM-PLUS T 100W/U/UVS/G12/942	00367	9000	12000	4200	90+	U	D	12
150W	CM-PLUS T 150W/U/UVS/G12/830	00368	15000	12000	3000	80+	U	D	12
150W	CM-PLUS T 150W/U/UVS/G12/942	00369	13500	12000	4200	90+	U	D	12

Ceramic Lamp MH-DE

Watts	Lamp Description	Product No.	Initial Lumens	Avg. Life Hours	CCT (K)	RA	Burn Pos.	Fig	Ctn. Qty
70W	CM-PLUS TD 70W/U/UVS/RX7s/830	00370	7000	15000	3000	80+	U	E	12
70W	CM-PLUS TD 70W/U/UVS/RX7s/942	00371	6600	15000	4200	90+	U	E	12
150W	CM-PLUS TD 150W/U/UVS/RX7s/830	00372	14000	15000	3000	80+	U	F	12
150W	CM-PLUS TD 150W/U/UVS/RX7s/942	00373	12500	15000	4200	90+	U	F	12

Ceramic Lamp Tubular

Watts	Lamp Description	Product No.	Initial Lumens	Avg. Life Hours	CCT (K)	RA	Burn Pos.	Fig	Ctn. Qty
70W	CM-PLUS TT 70W/U/UVS/830	00374	7000	18000	3000	80+	U	H	12
70W	CM-PLUS TT 70W/U/UVS/942	00375	6600	18000	4200	90+	U	H	12
100W	CM-PLUS TT 100W/U/UVS/830	00376	9500	18000	3000	80+	U	G	12
100W	CM-PLUS TT 100W/U/UVS/942	00377	9000	18000	4200	90+	U	G	12
150W	CM-PLUS TT 150W/U/UVS/830	00378	14000	18000	3000	80+	U	G	12
150W	CM-PLUS TT 150W/U/UVS/942	00379	13500	18000	4200	90+	U	G	12

Ceramic Lamp Elliptical

Watts	Lamp Description	Product No.	Initial Lumens	Avg. Life Hours	CCT (K)	RA	Burn Pos.	Fig	Ctn. Qty
70W	CM-PLUS ED 70W/U/UVS/830	00380	7000	18000	3000	80+	U	I	12
70W	CM-PLUS ED 70W/U/UVS/942	00381	6600	18000	4200	90+	U	I	12
100W	CM-PLUS ED 100W/U/UVS/830	00382	9500	18000	3000	80+	U	I	12
100W	CM-PLUS ED 100W/U/UVS/942	00383	9000	18000	4200	90+	U	I	12
150W	CM-PLUS ED 150W/U/UVS/830	00384	14000	18000	3000	80+	U	I	12
150W	CM-PLUS ED 150W/U/UVS/942	00385	13500	18000	4200	90+	U	I	12

All performance data is based on operation on Ventronic electronic ballasts

Some lamp descriptions include the 3 digit International Ra/CCT Code

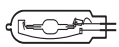

G8.5
Dia. = 14,5mm
MOL = 85mm
LCL = 52mm

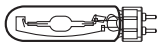

G12
Dia. = 14,5mm
MOL = 90mm
LCL = 56mm
Base = G12

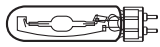

G12
Dia. = 19mm
MOL = 90mm
LCL = 56mm
Base = G12

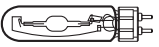

G12
Dia. = 19mm
MOL = 100mm
LCL = 56mm
Base = G12

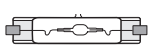

CMP70
Dia. = 23mm
MOL = 120mm
LCL = 57mm
Base = RX7S

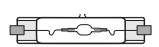

CMP150
Dia. = 23mm
MOL = 135mm
LCL = 66mm
Base = RX7S

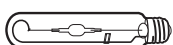

T46
Dia. = 46mm
MOL = 211mm
LCL = 132mm
Base = E40



T38
Dia. = 38mm
MOL = 156mm
LCL = 102mm
Base = E27



E54
Dia. = 54mm
MOL = 141mm
LCL = 89mm
Base = E27

CWA Metal Halide

Direct replacement for 'Multi-vapor' and 'Super Metal Arc' lamps. Operate on CWA control gear.

Features:

- Full range of wattages
- Clear and coated bulb finishes
- Reduced jacket options
- Choice of colour temperatures
- 400 watt lamps are open rated when operated base up $\pm 15^\circ$
- Asymmetric arc tube design allows horizontal $\pm 45^\circ$ operation

Applications:

- Universal – Floodlighting
Sports lighting
General lighting
- Vertical – Architectural area lighting
Commercial downlighting
Industrial highbay
- Horizontal – Advertising hoardings
Petrol station canopies
Indoor sports

Enclosed Rated

CWA Control Gear

Watts	Lamp Description	Product No.	Initial Lumens	Avg. Life Hours	CCT (K)	Warm-Up (Min)	Restrike (Min)	RA	Finish	Oper. Pos.	Fig.	Case Qty
175	HIE 175W/U/E54/EURO/4K	84971	14000V	10000V	4000	3-5	5-10	68	Clear	U	H	12
175	HIE 175W/C/U/E54/EURO/4K	24729	13300V	10000V	3700	3-5	5-10	70	Coated	U	H	12
175	HIE 175W/U/EURO/4K	36279	14000V	10000V	4000	3-5	5-10	68	Clear	U	A	12
175	HIE 175W/C/U/EURO/4K	40698	13300V	10000V	3700	3-5	5-10	70	Coated	U	A	12
250	HIE 250W/BU/EURO/4K	81203	23000	10000	4000	2-4	5-10	68	Clear	BU $\pm 15^\circ$	A	12
250	HIE 250W/C/BU/EURO/4K	81202	22000	10000	3700	2-4	5-10	70	Coated	BU $\pm 15^\circ$	A	12
250	HIE 250W/U/EURO/4K	88246	21000V	10000V	4000	3-5	5-10	68	Clear	U	A	12
250	HIE 250W/C/U/EURO/4K	21303	20000V	10000V	3700	3-5	5-10	70	Coated	U	A	12

Enclosed Rated

CWA Control Gear

Watts	Lamp Description	Product No.	Initial Lumens	Avg. Life Hours	CCT (K)	Warm-Up (Min)	Restrike (Min)	RA	Finish	Oper. Pos.	Fig.	Case Qty
400	HIE 400W/BU/EURO/4K	33544	40000	15000	4000	3-5	10-15	68	Clear	BU $\pm 15^\circ$	B	6
400	HIE 400W/C/BU/EURO/4K	31545	38000	15000	3700	3-5	10-15	70	Coated	BU $\pm 15^\circ$	B	6
400	HIE 400W/C/HOR/EURO/4K	63958	38000	15000	3700	3-5	10-15	70	Coated	HOR $\pm 45^\circ$	C	6
400	HIE 400W/U/EURO/4K	20137	36000V	15000V	4000	3-5	8-12	68	Clear	U	B	6
400	HIE 400W/C/U/E90/EURO/4K*	58122	34000V	15000V	3700	3-5	8-12	70	Coated	U	A	12
400	HIE 400W/C/U/EURO/4K	88787	34000V	15000V	3700	3-5	8-12	70	Coated	U	B	6

* Reduced jacket

Open Rated

CWA Control Gear

Watts	Lamp Description	Product No.	Initial Lumens	Avg. Life Hours	CCT (K)	Warm-Up (Min)	Restrike (Min)	RA	Finish	Oper. Pos.	Fig.	Case Qty
400	HIPE 400W/BU/EURO/4K	99441	38000	15000	4000	3-5	10-15	68	Clear	BU $\pm 15^\circ$	E	6
400	HIPE 400W/C/BU/EURO/4K	94102	36000	15000	3700	3-5	10-15	70	Coated	BU $\pm 15^\circ$	E	6

Enclosed Rated

Tubular

CWA Control Gear

Watts	Lamp Description	Product No.	Initial Lumens	Avg. Life Hours	CCT (K)	Warm-Up (Min)	Restrike (Min)	RA	Finish	Oper. Pos.	Fig.	Case Qty
250	HIT 250W/HOR/EURO/4K	57712	23000	10000	4000	3-5	5-10	68	Clear	HOR $\pm 45^\circ$	I	12
400	HIT 400W/HOR/EURO/4K	88410	40000	15000	4000	3-5	10-15	68	Clear	HOR $\pm 45^\circ$	D	12

Enclosed Rated

CWA Control Gear

Watts	Lamp Description	Product No.	Initial Lumens	Avg. Life Hours	CCT (K)	Warm-Up (Min)	Restrike (Min)	RA	Finish	Oper. Pos.	Fig.	Case Qty
1000	HIE 1000W/U/4K	46109	110000V	12000V	4000	3-5	10-15	68	Clear	U	F	6
1000	HIE 1000W/C/U/4K	12175	105000V	12000V	3700	3-5	10-15	70	Coated	U	F	6
1000	HIE 1000W/U/BT120/4K*	46423	105000V	12000V	4000	3-5	10-15	68	Clear	U	G	6

* Reduced jacket

Some lamp descriptions include the 3 digit International Ra/CCT Code

A

E90

Dia. = 90mm
MOL = 215mm
LCL = 131mm
Base = E40

B

E120

Dia. = 120mm
MOL = 296mm
LCL = 182mm
Base = E40

C

E120

Dia. = 120mm
MOL = 296mm
LCL = 182mm
Base = E40PO

D

T46

Dia. = 46mm
MOL = 285mm
LCL = 175mm
Base = E40PO

E

BT120

Dia. = 120mm
MOL = 296mm
LCL = 182mm
Base = E40

F

BT180

Dia. = 180mm
MOL = 395mm
LCL = 245mm
Base = E40

G

BT120

Dia. = 120mm
MOL = 296mm
LCL = 182mm
Base = E40

H

E54

Dia. = 54mm
MOL = 141mm
LCL = 89mm
Base = E27

High Wattage Lamps

Features include

- Compact linear lamp for excellent optical control
- Cooler base design for improved field performance
- High lumen output

Applications:

- Sports lighting
- Stadia
- Large area floodlighting

Open Rated

Pulse Start

Reactor Control Gear

Watts	Lamp Description	Lamp Current	Product No.	Initial Lumens	Avg. Life Hours	CCT (K)	Warm-Up (Min)	Restrike (Min)	RA	Finish	Oper. Pos.	Fig.	Case Qty
875	HIPE 875W/BU/PS/740	3.7	87588	95000	20000+	4000	3-5	8-12	68	Clear	BU±15°	I	6
875	HIPE 875W/C/BU/PS/4K	3.7	TBA	90000	20000+	3700	3-5	8-12	70	Coated	BU±15°	I	6

Enclosed Rated

Pulse Start

Reactor Control Gear

Watts	Lamp Description	Lamp Current	Product No.	Initial Lumens	Avg. Life Hours	CCT (K)	Warm-Up (Min)	Restrike (Min)	RA	Finish	Oper. Pos.	Fig.	Case Qty
875	HIE 875W/BU/PS/4K	3.7	85410	100000	20000+	4000	3-5	8-12	68	Clear	BU±15°	I	6

Enclosed Rated

Tubular White-Lux

HPS Control Gear

Lamp Watts	Product Description	Lamp Current	Initial No.	Avg. Life Lumens	CCT Hours	Warm-Up (K)	Restrike (Min)	(Min)	RA	Oper. Finish	Pos.	Case Fig. Qty
1000	HIT 1000W/U/LU/4K	10.3	83265	90000V	8000V	4000	3-5	10-15	68	Clear	U	G 6
1000	HIT1000W/U/LU/5K	10.3	00083	8000V	8000V	5000	3-5	10-15	68	Clear	U	G 6

Enclosed Rated

Double Ended (RSC-RX7s)

Reactor Control Gear

Watts	Lamp Description	Lamp Current	Product No.	Initial Lumens	Avg. Life Hours	CCT (K)	Warm-Up (Min)	Restrike (Min)	RA	Finish	Oper. Pos.	Fig.	Case Qty
1000	MBIL S 1000W	4.4	22417	80000H	6000H	5200	1-2	5-10	68	Frosted	HOR±15°	A	6
1500	MBIL S 1500W	6.7	22151	130000H	6000H	5200	2-4	5-10	68	Frosted	HOR±15°	B	6

Enclosed Rated

Reactor Control Gear

Watts	Lamp Description	Lamp Current	Product No.	Initial Lumens	Avg. Life Hours	CCT (K)	Warm-Up (Min)	Restrike (Min)	RA	Finish	Oper. Pos.	Fig.	Case Qty
1000	HIE 1000W/U/4K	4.1	46109	110000V	12000V	4000	3-5	10-15	68	Clear	U	E	6
1000	HIE 1000W/C/U/4K	4.1	12175	105000V	12000V	3700	3-5	10-15	70	Coated	U	E	6
1000	HIE 1000W/U/BT120/4K Note ②	4.1	46423	105000V	12000V	4000	3-5	10-15	68	Clear	U	F	6

Enclosed Rated

Tubular

Reactor Control Gear

Watts	Lamp Description	Lamp Current	Product No.	Initial Lumens	Avg. Life Hours	CCT (K)	Warm-Up (Min)	Restrike (Min)	RA	Finish	Oper. Pos.	Fig.	Case Qty
1000	HIT1000W/U/EURO/4K Note ①	8.2	00008	90000V	8000V	4000	3-5	10-15	68	Clear	U	G	6
1000	HIT1000W/U/EURO/5K Note ①	8.2	00282	80000V	8000V	5000	3-5	10-15	68	Clear	U	G	6
2000	HIT 2000W/U/4K Note ①&④	8.8	00066	230000V	5000V	4000	3-5	10-15	68	Clear	U	H	6
2000	HIT 2000W/U/230V/45K Note ①	16.5	00067	185000V	5000V	4500	3-5	10-15	68	Clear	U	H	6
2000	HIT 2000/U/EURO/45K Note ①&③	16.5	00387	185000V	5000V	4500	3-5	10-15	68	Clear	U	H	6

Enclosed Rated

Double Ended (Special Base)

Reactor Control Gear

Watts	Lamp Description	Lamp Current	Product No.	Initial Lumens	Avg. Life Hours	CCT (K)	Warm-Up (Min)	Restrike (Min)	RA	Finish	Oper. Pos.	Fig.	Case Qty
2000	MBIL S 2000W	10.3	22132	215000H	6000H	5200	10	15	68	Frosted	HOR±15°	C	2









Enclosed Rated

Double Ended (K12S-36)

Reactor Control Gear

Watts	Lamp Description	Lamp Current	Product No.	Initial Lumens	Avg. Life Hours	CCT (K)	Warm-Up (Min)	Restrike (Min)	RA	Finish	Oper. Pos.	Fig.	Case Qty
2000	MH-TS 2000W/L/K12/4K	10.3	84203	240000H	5000H	4500	3-5	10-15	68	Frosted	HOR±45°	D	2

Some lamp descriptions include the 3 digit International Ra/CCT Code

<p>A MBIL S Contacts = 256mm Effective arc length = 168mm Base = RSC (RX7s)</p> 	<p>B MBIL S Contacts = 256mm Effective arc length = 168mm Base = RSC (RX7s)</p> 	<p>C MBIL S Contacts = 311mm Effective arc length = 188mm Base = SINGLE CONTACT-SPECIAL</p> 	<p>D MH-TS D MOL = 270mm Nominal Arc Length = 142mm Base = K12S-36</p> 	<p>E BT180 Dia. = 180mm MOL = 395mm LCL = 245mm Base = E40</p> 	<p>F BT120 Dia. = 120mm MOL = 296mm LCL = 182mm Base = E40</p> 	<p>G T76 Dia. = 76mm MOL = 340mm LCL = 220mm Base = E40</p> 	<p>H T100 Dia. = 100mm MOL = 420mm LCL = 220mm Base = E40</p> 	<p>I E120 Dia. = 120mm MOL = 296mm LCL = 182mm Base = E40</p> 
---	---	---	---	--	--	---	--	---

Notes

Note ① Ignitor can be supplied with lamp

Note ② Reduced jacket

Note ③ Low voltage ignitor only

Note ④ High voltage ignitor only

Double Ended & G12

Features:

- Compact configuration
- Precise optical control
- Long life
- Excellent colour uniformity
- Uni-Form® formed body arc tube
- The lamps on this page feature UV Shield® ultraviolet protection (70, 100 and 150 Watt)

Applications:

- Accent lighting
- Downlighting
- Retail environments
- Showrooms

Enclosed Rated Single Ended (G12/BiPin)

UV Shield

UNI-FORM[®]
ARC TUBE TECHNOLOGY

HPS Reactor Gear

Watts	Lamp Description	Product No.	Initial Lumens	Avg. Life Hours	CCT (K)	Warm-Up (Min)	Restrike (Min)	RA	Finish	Oper. Pos.	Fig.	Case Qty
70	HIT 70W/G12/UVS/4K	52983	5600V	10000V	4200	1-2	2-4	70	Clear	U	A	25
70	HIT 70W/G12/UVS/3K	12108	5600V	10000V	3000	1-2	2-4	70	Clear	U	A	25
150	HIT 150W/G12/UVS/4K	25779	14000V	10000V	4200	1-2	2-4	70	Clear	U	A	25
150	HIT 150W/G12/UVS/3K	12106	14000V	10000V	3000	1-2	2-4	70	Clear	U	A	25

Enclosed Rated Double Ended (RSC-RX7s)

UV Shield

UNI-FORM[®]
ARC TUBE TECHNOLOGY

HPS Reactor Gear

Watts	Lamp Description	Product No.	Initial Lumens	Avg. Life Hours	CCT (K)	Warm-Up (Min)	Restrike (Min)	RA	Finish	Oper. Pos.	Fig.	Case Qty
70	MH-DE 70W/UVS/4K	60248	5500	10000	4200	1-2	2-4	70	Clear	HOR±45°	B	25
70	MH-DE 70W/UVS/3K	16786	5200	10000	3000	1-2	2-4	70	Clear	HOR±45°	B	25
70	MH-DE 70W/UVS/FS/6K	79470	4800	10000	6500	1-2	2-4	90	Clear	HOR±45°	B	25
150	MH-DE 150W/UVS/4K	74756	11250	10000	4200	1-2	2-4	70	Clear	HOR±45°	C	25
150	MH-DE 150W/UVS/3K	11295	11250	10000	3000	1-2	2-4	70	Clear	HOR±45°	C	25
150	MH-DE 150W/UVS/FS/6K	29963	11250	10000	6500	1-2	2-4	90	Clear	HOR±45°	C	25

Enclosed Rated Double Ended (Fc2)

HPS Reactor Gear

Watts	Lamp Description	Product No.	Initial Lumens	Avg. Life Hours	CCT (K)	Warm-Up (Min)	Restrike (Min)	RA	Finish	Oper. Pos.	Fig.	Case Qty
250	MH-DE 250W/3K/Fc2	84727	20000	10000	3000	2-4	5-10	70	Clear	HOR±45°	D	25
250	MH-DE 250W/4K/Fc2	72748	20000	10000	4200	2-4	5-10	70	Clear	HOR±45°	D	25

Some lamp descriptions include the 3 digit International Ra/CCT Code



A
G12

Dia. = 23mm
MOL = 110mm
LCL = 56mm
Base = G12

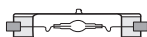

B
MH-DE

MOL = 114.2mm
Base = RSC (R7s)

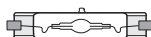

C
MH-DE

MOL = 132mm
Base = RSC (RX7s)

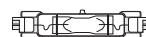

D
MH-DE

MOL = 163mm
Base = Fc2

Designer Colour

Features:

- Primary colour generation - no filtration required
- Highly efficient - fewer fixtures required
- Operate on standard ballasts
- Compact size - good optical control

Applications:

Theme parks
Architectural lighting
Building facades

Enclosed Rated Double Ended (RSC-RX7s)

UVShield™

UNI-FORM®
ARC TUBE TECHNOLOGY

Watts	Description	Lamp No.	Colour	Op. Pos.	Fig.	Case Qty
70	MH-DE 70W/UVS/BDX	00177	Blue	HOR±45°	A	25
70	MH-DE 70W/UVS/GDX	00178	Green	HOR±45°	A	25
70	MH-DE 70W/UVS/PDX	00179	Pink	HOR±45°	A	25
70	MH-DE 70W/UVS/MDX	00180	Magenta	HOR±45°	A	25
150	MH-DE 150W/UVS/BDX	33496	Blue	HOR±45°	B	25
150	MH-DE 150W/UVS/GDX	33851	Green	HOR±45°	B	25
150	MH-DE 150W/UVS/PDX	00181	Pink	HOR±45°	B	25
150	MH-DE 150W/UVS/MDX	00182	Magenta	HOR±45°	B	25

Enclosed Rated Single Ended (G12/BiPin)

UVShield™

UNI-FORM®
ARC TUBE TECHNOLOGY

Watts	Description	Lamp No.	Colour	Op. Pos.	Fig.	Case Qty
70	HIT 70W/G12/UVS/BDX	00183	Blue	U	C	25
70	HIT 70W/G12/UVS/GDX	00184	Green	U	C	25
70	HIT 70W/G12/UVS/PDX	00185	Pink	U	C	25
70	HIT 70W/G12/UVS/MDX	00186	Magenta	U	C	25
150	HIT 150W/G12/UVS/BDX	84684	Blue	U	C	25
150	HIT 150W/G12/UVS/GDX	26786	Green	U	C	25
150	HIT 150W/G12/UVS/PDX	00187	Pink	U	C	25
150	HIT 150W/G12/UVS/MDX	00188	Magenta	U	C	25

Enclosed Rated Single Ended (E27)





UNI-FORM®
ARC TUBE TECHNOLOGY

Watts	Description	Lamp No.	Colour	Op. Pos.	Fig.	Case Qty
150	HIE 150W/U/LU/BDX	33051	Blue	U	D	12
150	HIE 150W/U/LU/GDX	33520	Green	U	D	12
150	HIE 150W/U/LU/PDX	00189	Pink	U	D	12
150	HIE 150W/U/LU/MDX	00190	Magenta	U	D	12

Enclosed Rated Single Ended Tubular (E40)

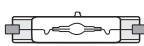
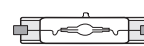
Watts	Description	Lamp No.	Colour	Op. Pos.	Fig.	Case Qty
250	HIT 250W/U/LU/BDX	00163	Blue	U	E	12
250	HIT 250W/U/LU/GDX	00164	Green	U	E	12
250	HIT 250W/U/LU/PDX	00191	Pink	U	E	12
250	HIT 250W/U/LU/MDX	00192	Magenta	U	E	12
400	HIT 400W/U/EURO/BDX	88342	Blue	U	F	12
400	HIT 400W/U/EURO/GDX	64390	Green	U	F	12
400	HIT 400W/U/EURO/PDX	97354	Pink	U	F	12
400	HIT 400W/U/EURO/MDX	00242	Magenta	U	F	12
400	HIT 400W/U/LU/BDX	00239	Blue	U	F	12
400	HIT 400W/U/LU/GDX	00240	Green	U	F	12
400	HIT 400W/U/LU/PDX	00241	Pink	U	F	12
400	HIT 400W/U/LU/MDX	00194	Magenta	U	F	12
1000	HIT 1000W/U/LU/BDX	00195	Blue	U	G	6
1000	HIT 1000W/U/LU/GDX	00196	Green	U	G	6

Some lamp descriptions include the 3 digit International Ra/CCT Code

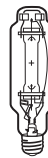
						
A	B	C	D	E	F	G
MH-E	MH-DE	G12	E54	T46	T46	T76
Contact to Contact= 114.2mm Base = RSC (RX7s)	Contact to Contact= 132mm Base = RSC (RX7s)	Dia. = 23mm MOL = 110mm LCL = 56mm Base = G12	Dia. = 54mm MOL = 141mm LCL = 89mm Base = E27	Dia. = 46mm MOL = 225mm LCL = 146mm Base = E40	Dia. = 46mm MOL = 285mm LCL = 175mm Base = E40	Dia. = 76mm MOL = 340mm LCL = 220mm Base = E40

Aquatic & Special Purpose Lamps

Enclosed Rated

Double Ended

UNI-FORM[®]
ARC TUBE TECHNOLOGY

Lamp Watts	Product Description	Product No.	Col. Temp.	Op. Pos.	Fig.	Case Qty
70	MH-DE 70W/6.5K	00255	6500	HOR±45°	A	25
70	MH-DE 70W/10K	00143	10000	HOR±45°	A	25
70	MH-DE 70W/15K	00256	15000	HOR±45°	A	25
70	MH-DE 70W/20K	00257	20000	HOR±45°	A	25
150	MH-DE 150W/6.5K	00258	6500	HOR±45°	B	25
150	MH-DE 150W/10K	00144	10000	HOR±45°	B	25
150	MH-DE 150W/15K	00259	15000	HOR±45°	B	25
150	MH-DE 150W/20K	00260	20000	HOR±45°	B	25

Enclosed Rated

Double Ended

UNI-FORM[®]
ARC TUBE TECHNOLOGY

Lamp Watts	Product Description	Product No.	Col. Temp.	Op. Pos.	Fig.	Case Qty
250	MH-DE 250W/6.5K	00261	6500	HOR±45°	C	25
250	MH-DE 250W/10K	00145	10000	HOR±45°	C	25
250	MH-DE 250W/15K	00262	15000	HOR±45°	C	25
250	MH-DE 250W/20K	00263	20000	HOR±45°	C	25

Enclosed Rated

Tubular E27

UNI-FORM[®]
ARC TUBE TECHNOLOGY

Lamp Watts	Product Description	Product No.	Col. Temp.	Op. Pos.	Fig.	Case Qty
150	HIT 150W/6.5K	00264	6500	U	D	12
150	HIT 150W/10K	00265	10000	U	D	12
150	HIT 150W/15K	00266	15000	U	D	12
150	HIT 150W/20K	00267	20000	U	D	12

Enclosed Rated

Tubular E40

Lamp Watts	Product Description	Product No.	Col. Temp.	Op. Pos.	Fig.	Case Qty
250	HIT 250W/6.5K	00268	6500	U	E	12
250	HIT 250W/10K	00146	10000	U	E	12
250	HIT 250W/15K	00269	15000	U	E	12
250	HIT 250W/20K	00270	20000	U	E	12
400	HIT 400W/6.5K	00271	6500	U	F	12
400	HIT 400W/10K	00147	10000	U	F	12
400	HIT 400W/15K	00272	15000	U	F	12
400	HIT 400W/20K	00273	20000	U	F	12
1000	HIT 1000W/10K	00274	10000	U	G	6

Open Rated

UNI-FORM[®]
ARC TUBE TECHNOLOGY

Lamp Watts	Product Description	Product No.	Col. Temp.	Op. Pos.	Fig.	Case Qty
250	HIPT 250W/10K	00275	10000	U	H	12
400	HIPT 400W/10K	00276	10000	U	I	12

Please contact the sales office for details of suitable control gear.

Some lamp descriptions include the 3 digit International Ra/CCT Code



A
MH-DE

MOL = 114.2mm
Base = RSC (R7s)

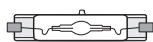

B
MH-DE

MOL = 132mm
Base = RSC (RX7s)

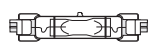

C
MH-DE

MOL = 163mm
Base = Fc2

D
T38

Dia. = 38mm
MOL = 156mm
LCL = 102mm
Base = E27



E
T46

Dia. = 46mm
MOL = 225mm
LCL = 146mm
Base = E40



F
T46

Dia. = 46mm
MOL = 285mm
LCL = 175mm
Base = E40



G
T76

Dia. = 76mm
MOL = 340mm
LCL = 220mm
Base = E40

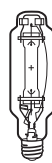

H
T52

Dia. = 52mm
MOL = 211mm
LCL = 132mm
Base = E40



I
T52

Dia. = 52mm
MOL = 225mm
LCL = 146mm
Base = E40



Description Codes & Ordering Information

Metal Halide Lamp Description Code:

Your lamp has an imprinted code that identifies the important features you need to select a replacement. A complete explanation appears below.

Lamp Description Example: HIPE 150W/C/U/LU/E90/UVS/4K

Lamp Type: 150 watt White-Lux® Plus pulse start lamp, open luminaire rated, universal burning, coated, reduced outer jacket with UV Shield® protection

HIPE	150W	C	U	LU	E90	UVS	4K
Metal halide type	Lamp wattage	Outer jacket finish	Operating position	White-Lux® Plus lamp	Bulb shape and diameter, if non-standard	UV Shield® lamp	Colour temperature family



LAMP DESCRIPTION CODES

- HIE** E27 or E40 European-based elliptical bulb, enclosed luminaire required
- HIPE** E27 or E40 European-based elliptical bulb, protected arc tube for open luminaire operation
- HIPT** E27 or E40 European-based tubular bulb, protected arc tube for open luminaire operation
- HIT** E40 European-based tubular bulb, arc tube for enclosed luminaire operation
- MBIL** High wattage, double ended lamp
- MH** E26 or E39 North American-based metal halide elliptical bulb, enclosed luminaire required
- MH-DE** Double-ended metal halide lamp
- MH-TS** Double-ended metal halide lamp with a fly-wire contact
- C** Lamps with a coated (diffuse) outer jacket
- BU** Lamps designed for base up ($\pm 15^\circ$) operating position
- V** Lamps designed for a vertical ($\pm 15^\circ$) operating position
- H75** Lamps designed for horizontal operation $\pm 75^\circ$,
- HBU** Lamps designed for horizontal to base up operating position (or base up $\pm 90^\circ$)
- HO** High Output
- HOR** Horizontal operating position
- EL** Lamp optimised for Ventronic ballasts

- U** Universal operating position
- LU** White-Lux® metal halide lamp designed for use with HPS control gear
- EURO** Lamps designed to run on mercury reactor ballast with low pulse ignitors, usually in Europe. Euro lamps can also operate on CWA gear. See page 18-19 for more information.
- WLC** White-Lux® City metal halide lamp featuring UV Shield® tubular lamps designed for horizontal operation and for use with HPS gear.
- E##** Bulb shape (elliptical) and diameter in millimeters
- K##** Spade connectors and the width of the fly-lead wire in millimeters
- T##** Bulb shape (tubular) and diameter in millimeters
- UVS** UV Shield® lamps with reduced ultraviolet output
- PS** Uni-Form® pulse start lamp featuring Venture's exclusive formed body arc tube designed to follow the curve of the arc stream
- 27K** 2700K - 2800K correlated colour temperature (nominal)
- 3K** 3000K - 3200K correlated colour temperature (nominal)
- 4K** 3700K - 4000K correlated colour temperature (nominal)
- 5K** 5000K correlated colour temperature (nominal)
- 6K** 6500K correlated colour temperature (nominal)

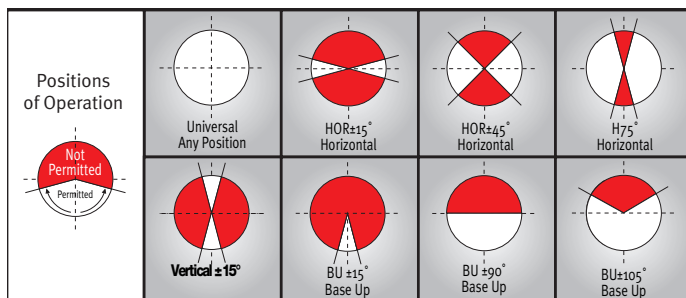

- CM-PLUS** Ceramic Metal Halide
- TC** Ceramic lamps with G8.5 base
- T** Ceramic lamps with G12 base
- TD** Double ended ceramic lamps
- TT** Tubular ceramic lamps
- ED** Elliptical Ceramic lamps

Ventronic Dimmable HID Control Gear

Ballasts

Ventronic



28



Ventronic Dimmable HID Control Gear

Introducing Ventronic from Venture Lighting, one of the world's leading names in advanced lighting design and technology.

With the Ventronic solution, you can determine the light levels you require at any given time, either manually, automatically through the use of light meters or by programmable options.

Saves money by making use of ambient light

With conventional control gear the light is either ON or OFF. You burn full power - even when you don't need it. However, using Ventronic, the lights can be dimmed when it's bright outside, and only revert to a higher power when necessary. Ventronic can also be linked to a PIR sensor to produce more light when a particular area is occupied.

'Daylight Harvesting', as this technique is referred to, is an excellent way of saving energy costs and extending the life of the lamp without compromising on light levels. As it takes into consideration and therefore makes use of natural ambient light, it can also make a very positive contribution to a company's environmental policies.



Ventronic Dimmable HID Control Gear

Only Ventronic Offers You all These Benefits

- Significantly increased lumen maintenance
- Vastly improved lamp life
- Superior light quality
- Exceptional energy savings
- Dimming
- Daylight harvesting
- Economy mode
- High efficiency
- Soft start ignition technology
- No start - up current
- Controllability
- Simple installation with reduced costs
- Reduced maintenance
- Built-in diagnostics
- High reliability
- High Power Factor
- Thermal Protection with auto reset
- ENEC and VDE approved
- No ignitor required
- No capacitor required
- Ballast operates upto approximately 30 meters from lamp - 3000pF max.

Ventronic Models Currently Available

Ventronic is available in the following wattages suitable to operate both HPS and Venture Metal Halide Pulse Start Lamps, 150W, 200W, 250W, 320W, 350W, 400W, 450W and 600W.



Ordering Information

As standard, Ventronic is supplied with internal dimming control switches. A communication or control option can be ordered separately.

- SEEP module
- RS485 interface
- Wireless communication



Ventronic POD

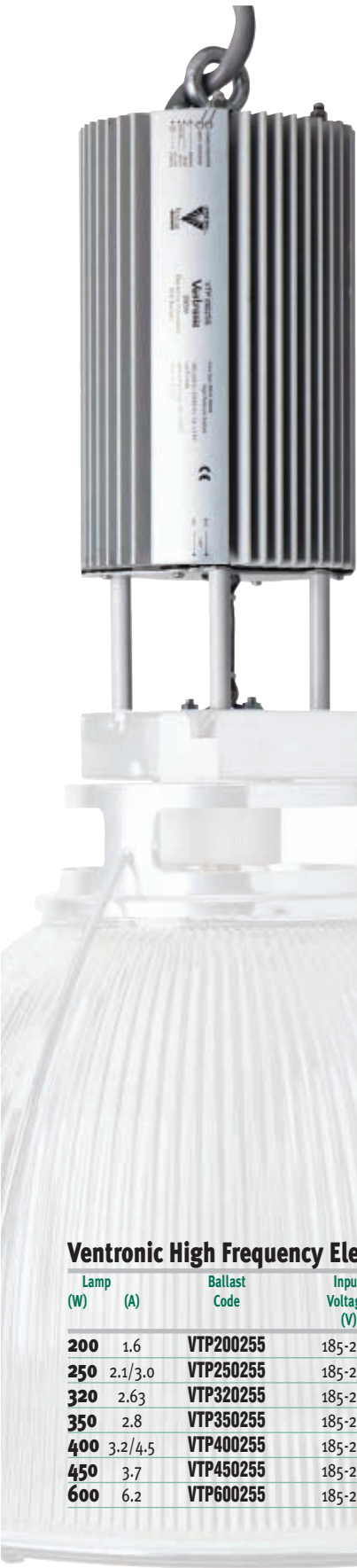

- Thermally designed convective case.
- Complies with relevant sections of EN 61347-1.
- Fully EMC compliant.
- Can be customised to suit OEM requirements.

fig 39

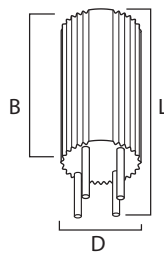

Ventronic High Frequency Electronic Dimmable Control Gear For HPS and Venture MH Pulse Start lamps

Lamp (W)	(A)	Ballast Code	Input Voltage (V)	Circuit Watts (W)	Running Current (A)	Max Case Temp (tc)	Dimensions (Dia x L B / Fix) (mm)	Weight (kg)	Fig	Circuit Diagram	Lamp Types
200	1.6	VTP200255	185-254	216	0.9	90	132x332 212 / 55 x 90 x M5	1.9	39	W1	Venture Pulse Start and HPS Lamps
250	2.1/3.0	VTP250255	185-254	270	1.13	90	132x332 212 / 55 x 90 x M5	1.9	39	W1	Venture Pulse Start and HPS Lamps
320	2.63	VTP320255	185-254	346	1.3	90	132x332 212 / 55 x 90 x M5	2.4	39	W1	Venture Pulse Start and HPS Lamps
350	2.8	VTP350255	185-254	378	1.6	90	132x332 212 / 55 x 90 x M5	2.4	39	W1	Venture Pulse Start and HPS Lamps
400	3.2/4.5	VTP400255	185-254	432	1.8	90	132x332 212 / 55 x 90 x M5	2.4	39	W1	Venture Pulse Start and HPS Lamps
450	3.7	VTP450255	185-254	482	2.0	90	132x332 212 / 55 x 90 x M5	2.4	39	W1	Venture Pulse Start and HPS Lamps
600	6.2	VTP600255	185-254	650	2.7	90	132x332 212 / 55 x 90 x M5	2.6	39	W1	Venture Pulse Start and HPS Lamps

Ventronic Low Wattage



Only Ventronic Offers You all These Benefits

- Perfect partner for track spotlights
- Metal base and enclosure
- Ignition voltage <2,5kV
- ENEC approval
- 2.5mm² terminal block
- Available in 120V (on request - different dimensions)

- Fast start
- Compact and lightweight
- Microprocessor controlled
- Remote operation up to 25m
- Easy fixing
- Accepts 0.75mm² to 2.5mm² solid and stranded cable

- Operate stand-alone or
- Compatible with WiMAC⁸⁶⁸
- 3 Output Light Levels (50%, 75%, 100%) + Off
- Conformally coated for moisture resistance

- Can be dimmable to 50% power at midnight (or other factory preset time) and if still on after 6 hours, switches back to full power
- Operates from a photocell
- Energy saving
- Operates Ceramic Metal Halide, Quartz Metal Halide, HPS

Ventronic HID Control Gear

Ventronic Electronic Control Gear

Terminal Block Versions

Lamp (W)	(A)	Ballast Code	Input Voltage (V)	Circuit Watts (W)	Running Current (A)	Max Case Temp (tc)	Dimensions (LxWxH/Fix) (mm)	Weight (kg)	Fig	Circuit Diagram	Lamp Types
20	0.225	V20MSB255	185-254	24	0.1	80	116 x 76 x 32/100 x 64	0.23	31	V2	UNI-FORM CMH, BritSpot
25	TBA	V25MSB255	185-254	29	0.12	80	116 x 76 x 32/100 x 64	0.23	31	V2	UNI-FORM
35	0.5	V35MSB255	185-254	45	0.19	80	116 x 76 x 32/100 x 64	0.23	31	V2	UNI-FORM CMH, CDM, HCI, ColorArc, BritSpot
50	0.76	V50MSB255	185-254	56	0.23	80	116 x 76 x 32/100 x 64	0.23	31	V2	UNI-FORM CMH, CDM, HCI, ColorArc
70	1.0	V70MSB255	185-254	79	0.33	80	116 x 76 x 32/100 x 64	0.23	31	V2	UNI-FORM CMH, CDM, HCI, ColorArc
100	1.1	V100SSB255	185-254	110	0.46	80	144 x 91 x 37/130 - 135 x 73 - 78	0.425	31	V2	UNI-FORM CMH, CDM, HCI, SON, ColorArc
150	1.8	V150SSB255	185-254	161	0.67	80	144 x 91 x 37/130 - 135 x 73 - 78	0.425	31	V2	UNI-FORM CMH, CDM, HCI, SON, ColorArc

Ventronic Electronic Control Gear

Cable Clamp Versions

Lamp (W)	(A)	Ballast Code	Input Voltage (V)	Circuit Watts (W)	Running Current (A)	Max Case Temp (tc)	Dimensions (LxWxH/Fix) (mm)	Weight (kg)	Fig	Circuit Diagram	Lamp Types
20	0.225	V20MSC255	185-254	24	0.1	80	116 x 76 x 32/100 x 64	0.23	33	V2	CMH
25	TBA	V25MSC255	185-254	29	0.12	80	116 x 76 x 32/100 x 64	0.23	33	V2	UNI-FORM
35	0.54	V35MSC255	185-254	45	0.19	80	116 x 76 x 32/100 x 64	0.23	33	V2	UNI-FORM CMH, CDM, HCI, ColorArc
50	0.76	V50MSC255	185-254	56	0.23	80	116 x 76 x 32/100 x 64	0.23	33	V2	UNI-FORM CMH, CDM, HCI, ColorArc
70	1.0	V70MSC255	185-254	79	0.33	80	116 x 76 x 32/100 x 64	0.23	33	V2	UNI-FORM CMH, CDM, HCI, ColorArc
100	1.1	V100SSC255	185-254	110	0.46	80	171 x 91 x 37/147	0.425	33	V2	UNI-FORM CMH, CDM, HCI, SON, ColorArc
150	1.8	V150SSC255	185-254	161	0.67	80	171 x 91 x 37/147	0.425	33	V2	UNI-FORM CMH, CDM, HCI, SON, ColorArc

Ventronic Electronic Control Gear WiMAC⁸⁶⁸ Enabled

Terminal Block Versions

Lamp (W)	(A)	Ballast Code	Input Voltage (V)	Circuit Watts (W)	Running Current (A)	Max Case Temp (tc)	Dimensions (LxWxH/Fix) (mm)	Weight (kg)	Fig	Circuit Diagram	Lamp Types
70	1.0	V70SSB255-WiMAC	185-254	79	0.33	80	144 x 91 x 37/130 - 135	0.23	32	U2	UNI-FORM CMH, CDM, HCI, SON, SDW-T, ColorArc
100	1.1	V100SSB255-WiMAC	185-254	110	0.46	80	144 x 91 x 37/130 - 135	0.425	32	U2	UNI-FORM CMH, CDM, HCI, SON, SDW-T, ColorArc
150	1.8	V150SSB255-WiMAC	185-254	161	0.67	80	144 x 91 x 37/130 - 135	0.425	32	U2	UNI-FORM CMH, CDM, HCI, SON, SDW-T, ColorArc

Ventronic Electronic Dimmable Control Gear Part Night

Terminal Block Versions

Lamp (W)	(A)	Ballast Code	Input Voltage (V)	Circuit Watts (W)	Running Current (A)	Max Case Temp (tc)	Dimensions (LxWxH/Fix) (mm)	Weight (kg)	Fig	Circuit Diagram	Lamp Types
70	1.0	V70SSB255-PN	185-254	79	0.33	80	144 x 91 x 37/130 - 135	0.23	31	V2	UNI-FORM CMH, CDM, HCI, SON, SDW-T, ColorArc
100	1.1	V100SSB255-PN	185-254	110	0.46	80	144 x 91 x 37/130 - 135	0.425	31	V2	UNI-FORM CMH, CDM, HCI, SON, SDW-T, ColorArc
150	1.8	V150SSB255-PN	185-254	161	0.67	80	144 x 91 x 37/130 - 135	0.425	31	V2	UNI-FORM CMH, CDM, HCI, SON, SDW-T, ColorArc

Ventronic Electronic Dimmable Control Gear Switch Dimming

Terminal Block Versions

Lamp (W)	(A)	Ballast Code	Input Voltage (V)	Circuit Watts (W)	Running Current (A)	Max Case Temp (tc)	Dimensions (LxWxH/Fix) (mm)	Weight (kg)	Fig	Circuit Diagram	Lamp Types
70	1.0	V70SSB255-SD	185-254	79	0.33	80	144 x 91 x 37/130 - 135	0.23	31	W2	UNI-FORM CMH, CDM, HCI, SON, SDW-T, ColorArc
100	1.1	V100SSB255-SD	185-254	110	0.46	80	144 x 91 x 37/130 - 135	0.425	31	W2	UNI-FORM CMH, CDM, HCI, SON, SDW-T, ColorArc
150	1.8	V150SSB255-SD	185-254	161	0.67	80	144 x 91 x 37/130 - 135	0.425	31	W2	UNI-FORM CMH, CDM, HCI, SON, SDW-T, ColorArc

Ventronic High Frequency Electronic Dimmable Control Gear For HPS and Venture MH UNI-FORM Pulse Start lamps

Lamp (W)	(A)	Ballast Code	Input Voltage (V)	Circuit Watts (W)	Running Current (A)	Max Case Temp (tc)	Dimensions (LxWxH/Fix) (mm)	Weight (kg)	Fig	Circuit Diagram	Lamp Types
200	1.6	VTC200255	185-254	216	0.9	90	196 x 108 x 82/210	1.7	29	W1	Venture UNI-FORM Pulse Start and HPS Lamps
250	2.1/3.0	VTC250255	185-254	270	1.13	90	196 x 108 x 82/210	1.7	29	W1	Venture UNI-FORM Pulse Start and HPS Lamps
320	2.63	VTC320255	185-254	346	1.3	90	219 x 120 x 91/233	2.2	29	W1	Venture UNI-FORM Pulse Start and HPS Lamps
350	2.8	VTC350255	185-254	378	1.6	90	219 x 120 x 91/233	2.2	29	W1	Venture UNI-FORM Pulse Start and HPS Lamps
400	3.2/4.5	VTC400255	185-254	432	1.8	90	219 x 120 x 91/233	2.2	29	W1	Venture UNI-FORM Pulse Start and HPS Lamps
450	3.7	VTC450255	185-254	482	2.0	90	219 x 120 x 91/233	2.2	29	W1	Venture UNI-FORM Pulse Start and HPS Lamps
600	6.2	VTC600255	185-254	650	2.7	90	230 x 120 x 91/244	2.4	29	W1	Venture UNI-FORM Pulse Start and HPS Lamps

fig 29

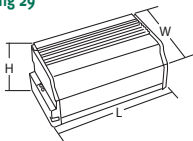

fig 31

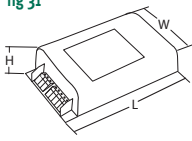

fig 32

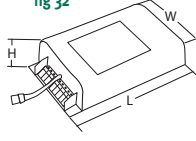
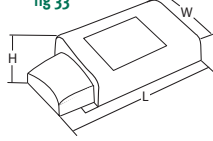

fig 33



For Ventronic POD details see page 31

Venture Parmar Ballasts



PARMAR HID control gear has been recognised for its quality and performance since the PARRY manufacturing company was formed by Mr Parry and Mr Martin (PARMAR) 60 years ago.

Synonymous with bespoke and specialist control gear the Venture Parmar range of HID Control Gear can be found in highly specialist luminaires such as those used in explosive atmospheres or in road and tunnel lighting as well as conventional commercial and industrial markets.

The acquisition of the PARMAR brand by Venture Lighting International in the late 1990's provided the foundation to build the current extensive range of both electro-magnetic and electronic HID control gear.

Accommodating our Technical and Product Managers, Venture Lighting's European Technical & Distribution Centre at Castle Donington is centrally located in the UK, housing our enviably large and unmatched UK stock of lamps, ballasts, ignitors and capacitors





With a huge product offering, boasting in excess of 500 types, Venture Lighting Europe will today supply HID ballasts of all wattages from 35W through to 3.5kW – single voltage 50Hz through to multi voltage 50 & 60Hz with Ignitors to suit all lamp & ballast types, including timed & long distance remote mounting

In support of our ballast and ignitors, we also offer a large range of PFC lighting Capacitors available in all values, both standard 250V and high voltage 440V

Venture PARMAR HID control gear, high performance and quality product range, available from UK stock to support our European Lighting Industry. First Class HID control gear, second to none service and supply



The J-Range and P-Range

HID Ballast

Metal Halide lamps from Venture Lighting Europe are widely recognised to be the best in the world, combining technical innovation with truly outstanding performance.

And to get the very best from your lamps, you need the very best control gear.

Introducing the new, high quality I-Pac Ballast and Ignitor system - combining the advanced P-range and further enhanced



The P-Range and further enhanced J-Range HID ballast group includes units rated at 35W, 50W, 70W, 100W, 150W, 250W, 400W HPS & 250W, 400W HPMV. Each features an impressive, low weight design and offers a standard "European" footprint.

Precision Wound and High Build Quality

All ballasts in the range are Precision Wound to provide the best possible thermal and electrical durability. This method offers distinct advantages over the conventional

J-range Ballast with the Mci Series Ignitor to offer optimum performance from all Venture Metal Halide lamps.

Together, they have been optimised for maximum performance and reliability, through all wattages from 35W to 600W, offering a fully universal solution

Scramble Winding

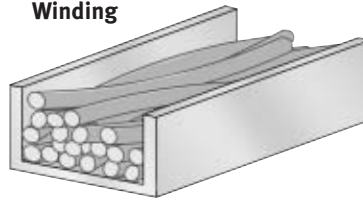

Precision Winding

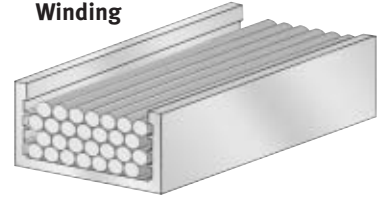

Scramble or Random Wound methods. With Precision Winding, each coil is wound onto grooved insulation material, ensuring that each turn of wire is accurately positioned in parallel with each one of its neighbouring/adjacent turns of wire. A high grade of winding wire classified above 200C is always used to further enhance performance and reliability. This, coupled with Venture's intensive Vacuum Impregnation methods, guarantees the highest possible standards, and ensures the longest possible ballast life.

High Grade Thermal Protection

P-Range and further enhanced J-Range HID ballasts are thermally protected at 160C a value specifically chosen that will protect the ballast against any abnormal conditions and will eliminate nuisance tripping in poorly ventilated / high ambient temperature areas.

Excellent Temperature Characteristics

The lower wattages in the P-Range and further enhanced J-Range are as low as Delta t 60°C. Indeed, the 400W @ 240V is only 75°C. To compliment this further, all P-Range units are rated tw.140°C



The MCI Series Ignitor

The Venture MCI Series Ignitor is a digital, intelligent timed ignitor, designed for universal operation covering 35W through to 600W.

Compact Design

The MCI ignitor is only 5cm in length, with a cross section of less than 2.5cm x 2.0cm - making it ideal for installations where space is at an absolute premium.

Zero Watts Loss - and No Internal Temperature Rise

Unlike all conventional SIP ignitors, the MCI Series ignitor does not add a single Watt of power - or a single degree of heat to your light fitting. This means a more cost and energy efficient performance, while helping to prolong the life of the unit and thus reducing maintenance requirements.

A Longer Reach

"Remote lamp" situations no longer pose any problems, as the MCI Series ignitor is designed to reliably strike a lamp up to a distance of 10 Metres.

Digital Intelligence

The unit has been specifically designed to offer minimum stress to all circuit components, minimum radio frequency interference combined with minimum Hot Re-Strike time.

The MCI Series ignitor does not continuously pulse for 20 minutes. Whilst monitoring the circuit, an initial 5 second pulse cycle will try to strike the lamp. In the event the lamp does not strike, the pulsing will pause for 1 minute, before repeating another 5 second pulse cycle. This process will continue until the lamp strikes, or until the 20 minutes have elapsed.

By holding off the high voltage pulses in 1 minute segments, all HID circuits and components are protected. Any radio frequency interference is kept to a bare minimum, and a hot lamp arc tube is allowed to cool much quicker, resulting in a faster hot re-strike.

The timing circuit is also intelligent enough to distinguish between a cycling lamp and a mains supply interruption, allowing 3 lamp cycles before shutting down.



Component Benefits at a Glance

J-range & P-Range HID ballast

- Covers 35W, 50W, 70W, 100W, 150W 250, 400W HPS and 250, 400W HPMV lamps
- Compact, lightweight design with 'European' footprint
- High temperature thermal protection to eliminate nuisance tripping
- Precision wound and using vacuum impregnation for maximum life

MCI Series Ignitor

- Digital intelligent timed ignitor for universal operation
- Offers zero watts loss and no internal temperature rise
- 10 metre range eliminates remote lamp problems
- Virtually eliminates component stress and radio frequency interference

Control Gear for HPS, MH & Ceramic MH Lamps

35W & 50W

50Hz Control Gear For HPS, MH & Ceramic MH Lamps

Lamp (W)	(A)	Ballast Code	Input Voltage (V)	Circuit Watts (W)	Running Current (A)	Δt/tw (°C)	Dimensions LxWxH/Fix (mm)	Weight (kg)	TC	Fig	Capacitor μF/V	Standard Ignitor	Circuit	Timed Ignitor	Circuit
35	0.54	HSA03723221	230/240	48	0.24	60/140	120 x 69 x 56/106-111 Note ③	TBA	Y	17	6/250	PAE400255*	Y	MCi6*	X
												PXE070255	Y	PCX070255	Y
												PXE100255*	Y	PCX400255*	Y
35	0.54	HSJ03723221	230/240	48	0.24	60/140	106 x 68 x 56/86-97 Note ②	1.0	Y	35	6/250	PAE400255*	Y	MCi6*	X
												PXE070255	Y	PCX070255	Y
												PXE100255*	Y	PCX400255*	Y
35	0.54	HSP03723221	230/240	48	0.24	60/140	106 x 65 x 52/52 x 86-98	0.8	Y	2	6/250	PAE400255*	Y	MCi6*	X
												PXE070255	Y	PCX070255	Y
												PXE100255*	Y	PCX400255*	Y
35	0.54	DGO38822221	220/230/240/250	48	0.24	60/140	153 x 53 x 46/131-146	0.9	Y	7	6/250	PAE400255*	N	PCX070255	N
												PXE070255	N	PCX400255*	N
												PXE100255*	N		
50	0.76	HSA05223221	230/240	63	0.29	70/140	120 x 69 x 56/106-111 Note ③	1.1	Y	17	8/250	PAE400255*	Y	MCi57	X
												PXE070255	Y	MCi6*	X
												PXE100255*	Y	PCX070255	Y
50	0.76	HSJ05223221	230/240	63	0.29	70/140	106 x 68 x 56/86-97 Note ②	1.2	Y	35	8/250	PAE400255*	Y	MCi57	X
												PXE070255	Y	MCi6*	X
												PXE100255*	Y	PCX070255	Y
50	0.76	HSP05223221	230/240	63	0.29	70/140	106 x 65 x 52/52 x 86-98	1	Y	2	8/250	PAE400255*	Y	MCi57	X
												PXE070255	Y	MCi6*	X
												PXE100255*	Y	PCX070255	Y
50	0.76	HSG05322221	220/230/240/250	65	0.3	70/140	173 x 53 x 46/150-165	1.1	Y	7	8/250	PAE400255*	N	PCX070255	N
												PBo70K255	A1	PCX400255*	N
												PXE070255	N	PJ070K255	A1
50	0.76	HSZ05322221	220/230/240/250	62	0.29	55/140	100 x 66 x 46/52 x 57-68	1.2	Y	1	8/250	PAE400255*	N	PCX070255	N
												PBo70K255	A1	PCX400255*	N
												PXE070255	N	PJ070K255	A1
50	0.76	HSV05222421	220/240	64	0.3	60/140	86 x 75 x 63/47 x 54 Note ①	1.2	Y	19	8/250	PAE400255*	F1	PCX070255	F1
												PBo70K255	G1	PCX400255*	F1
												PXE070255	F1	PJ070K255	G1
50/70	0.76/1.0	HSA57223221	230/240	62/85	0.29/0.39	70/140	120 x 69 x 56/106-111 Note ③	1.6	Y	17	8/250 10/250	PAE400255*	U	MCi57	P1
												PXE070255	U	PCX070255	U
												PXE100255*	U	PCX400255*	U
50/70	0.76/1.0	HSJ57223221	230/240	62/85	0.29/0.39	70/140	106 x 68 x 56/86-97 Note ②	1.3	Y	35	8/250 10/250	PAE400255*	U	MCi57	P1
												PXE070255	U	PCX070255	U
												PXE100255*	U	PCX400255*	U
50/70	0.76/1.0	HSP57223221	230/240	62/85	0.29/0.39	70/140	106 x 65 x 52/52 x 86-98	1.3	Y	2	8/250 10/250	PAE400255*	U	MCi57	P1
												PXE070255	U	PCX070255	U
												PXE100255*	U	PCX400255*	U
50/70	0.76/1.0	HSG57024521	240	65/86	0.3/0.4	70/140	173 x 53 x 46/150-165	1.5	Y	7	8/250 10/250	PAE400255*	Q1	PCX070255	Q1
												PXE070255	Q1	PCX400255*	Q1
												PXE100255*	Q1		
50/70	0.76/1.0	HSZ57223221	230/240	62/85	0.29/0.39	70/140	118 x 66 x 46/52 x 75-86	1.5	Y	1	8/250 10/250	PAE400255*	U	PCX070255	U
												PXE070255	U	PCX400255*	U
												PXE100255*	U		

60Hz Control Gear For HPS, MH & Ceramic MH Lamps

Lamp (W)	(A)	Ballast Code	Input Voltage (V)	Circuit Watts (W)	Running Current (A)	Δt/tw (°C)	Dimensions LxWxH/Fix (mm)	Weight (kg)	TC	Fig	Capacitor μF/V	Standard Ignitor	Circuit	Timed Ignitor	Circuit
35	0.54	HSA037222BD	220/230	48	0.24	70/140	120 x 69 x 56/106-111 Note ③	TBA	Y	17	5/250	PAE400255*	J1	MCi6-6*	H1
												PXE070255	J1	PCX070255	J1
												PXE100255*	J1	PCX400255*	J1
35	0.54	HSJ037222BD	220/230	48	0.24	70/140	106 x 68 x 56/86-97 Note ②	TBA	Y	35	5/250	PAE400255*	J1	MCi6-6*	H1
												PXE070255	J1	PCX070255	J1
												PXE100255*	J1	PCX400255*	J1
35	0.54	HSP037222BD	220/230	48	0.24	70/140	106 x 65 x 52/52 x 86-98	0.8	Y	2	5/250	PAE400255*	J1	MCi6-6*	H1
												PXE070255	J1	PCX070255	J1
												PXE100255*	J1	PCX400255*	J1
50	0.76	HSA052222BD	220/230	63	0.29	70/140	120 x 69 x 56/106-111 Note ③	1.1	Y	17	7/250	PAE400255*	J1	MCi6-6*	H1
												PXE070255	J1	PCX070255	J1
												PXE100255*	J1	PCX400255*	J1
50	0.76	HSJ052222BD	220/230	63	0.29	70/140	106 x 68 x 56/86-97 Note ②	1.2	Y	35	7/250	PAE400255*	J1	MCi6-6*	H1
												PXE070255	J1	PCX070255	J1
												PXE100255*	J1	PCX400255*	J1
50	0.76	HSP052222BD	220/230	63	0.29	70/140	106 x 65 x 52/52 x 86-98	1	Y	2	7/250	PAE400255*	J1	MCi6-6*	H1
												PXE070255	J1	PCX070255	J1
												PXE100255*	J1	PCX400255*	J1

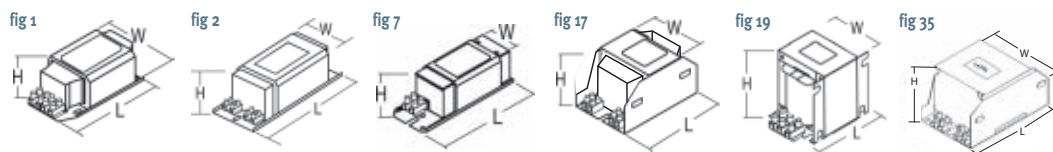

Notes

- Note ① Additional fixings 47 x 42 mm
- Note ② Additional fixings 52 x 86 - 92 mm and side fixings 84 - 96 mm
- Note ③ Additional fixings 53 x 96 - 109 mm and side fixings 95 - 109 mm

* These ignitors produce 3.0 - 4.5kV and are suitable for MH lamps and some HPS and Ceramic Lamps

Control Gear for HPS, MH & Ceramic MH Lamps

70W

Ballasts
70W

50Hz Control Gear For HPS, MH & Ceramic MH Lamps

Lamp (W)	Lamp (A)	Ballast Code	Input Voltage (V)	Circuit Watts (W)	Running Current (A)	Δt/tw (°C)	Dimensions LxWxH/Fix (mm)	Weight (kg)	TC	Fig	Capacitor μF/V	Standard Ignitor	Circuit	Timed Ignitor	Circuit
70	1.0	HSA07223221	230/240	86	0.39	70/140	107 x 69 x 56/86-97 Note ③	1.4	Y	17	10/250	PAE400255* PXE070255 PXE100255*	Y Y Y	MCI57 MCI6* PCX070255 PCX400255*	X X Y Y
70	1.0	HSJ07223221	230/240	86	0.39	70/140	106 x 68 x 56/86-97 Note ①	1.3	Y	35	10/250	PAE400255* PXE070255 PXE100255*	Y Y Y	MCI57 MCI6* PCX070255 PCX400255*	X X Y Y
70	1.0	HSP07223221	230/240	86	0.39	70/140	106 x 65 x 52/52 x 86-98	1.1	Y	2	10/250	PAE400255* PXE070255 PXE100255*	Y Y Y	MCI57 MCI6* PCX070255 PCX400255*	X X Y Y
70	1.0	HSG07322221	220/230/240/250	86	0.4	65/140	173 x 53 x 46/150-165	1.3	Y	7	10/250	PAE400255* PB070K255 PXE070255 PXE100255*	N A1 N N	PCX070255 PCX400255* PJ070K255	N N A1 A1
70	1.0	HSZ07322221	220/230/240/250	85	0.39	60/140	118 x 66 x 46/52 x 75-86	1.4	Y	1	10/250	PAE400255* PB070K255 PXE070255 PXE100255*	N A1 N N	PCX070255 PCX400255* PJ070K255	N N A1 A1
70	1.0	HSV07322221	220/230/240/250	87	0.39	70/140	94 x 75 x 63/54 x 54 Note ②	1.5	Y	19	10/250	PAE400255* PB070K255 PXE070255 PXE100255*	N A1 N N	PCX070255 PCX400255* PJ070K255	N N A1 A1
50/70	0.76/1.0	HSA57223221	230/240	62/85	0.29/0.39	70/140	120 x 69 x 56/106-111 Note ④	1.3	Y	17	8/250 10/250	PAE400255* PXE070255 PXE100255*	U U U	MCI57 PCX070255 PCX400255*	P1 U U
50/70	0.76/1.0	HSJ57223221	230/240	62/85	0.29/0.39	70/140	106 x 68 x 56/86-97 Note ①	1.3	Y	35	8/250 10/250	PAE400255* PXE070255 PXE100255*	U U U	MCI57 PCX070255 PCX400255*	P1 U U
50/70	0.76/1.0	HSP57223221	230/240	62/85	0.29/0.39	70/140	106 x 65 x 52/52 x 86-98	1.3	Y	2	8/250 10/250	PAE400255* PXE070255 PXE100255*	U U U	MCI57 PCX070255 PCX400255*	P1 U U
50/70	0.76/1.0	HSG57024521	240	65/86	0.3/0.4	70/140	173 x 53 x 46/150-165	1.5	Y	7	8/250 10/250	PAE400255* PXE070255 PXE100255*	Q1 Q1 Q1	PCX070255 PCX400255*	Q1 Q1
50/70	0.76/1.0	HSZ57223221	230/240	62/85	0.29/0.39	70/140	118 x 66 x 46/52 x 75-86	1.5	Y	1	8/250 10/250	PAE400255* PXE070255 PXE100255*	U U U	PCX070255 PCX400255*	U U

60Hz Control Gear For HPS, MH & Ceramic MH Lamps

Lamp (W)	Lamp (A)	Ballast Code	Input Voltage (V)	Circuit Watts (W)	Running Current (A)	Δt/tw (°C)	Dimensions LxWxH/Fix (mm)	Weight (kg)	TC	Fig	Capacitor μF/V	Standard Ignitor	Circuit	Timed Ignitor	Circuit
70	1.0	HSA072222BD	220/230	86	0.39	70/140	120 x 69 x 56/106-111 Note ③	1.4	Y	17	8/250	PAE400255* PXE070255 PXE100255*	J1 J1 J1	MCI6-6* PCX070255 PCX400255*	H1 J1 J1
70	1.0	HSJ072222BD	220/230	86	0.39	70/140	106 x 68 x 56/86-97 Note ①	1.3	Y	35	8/250	PAE400255* PXE070255 PXE100255*	J1 J1 J1	MCI6-6* PCX070255 PCX400255*	H1 J1 J1
70	1.0	HSP072222BD	220/230	86	0.39	70/140	106 x 65 x 52/52 x 86-98	1.1	Y	2	8/250	PAE400255* PXE070255 PXE100255*	J1 J1 J1	MCI6-6* PCX070255 PCX400255*	H1 J1 J1
70	1.0	HSZ073226X7	220/230/240/254	85	0.39	60/140	118 x 66 x 46/52 x 75-86	1.4	Y	1	8/250	PAE400255* PB070K255 PXE070255 PXE100255*	L1 M1 L1 L1	PCX070255 PCX400255* PJ070K255	L1 L1 M1
70	1.0	HSZ072218Y2	210 (230 50Hz)	85	0.39	60/140	118 x 66 x 46/52 x 75-86	1.4	Y	1	8/250	PAE400255* PXE070255 PXE100255*	K1 K1 K1	PCX070255 PCX400255*	K1 K1

Notes

- Note ① Additional fixings 52 x 86 - 92 mm and side fixings 84 - 96 mm
- Note ② Additional fixings 54 x 42 mm
- Note ③ Additional fixings 53 x 96 - 109 mm and side fixings 95 - 109 mm
- Note ④ Additional fixings 53 x 96 - 109 mm

* These ignitors produce 3.0 - 4.5kV and are suitable for MH lamps and some HPS and Ceramic Lamps

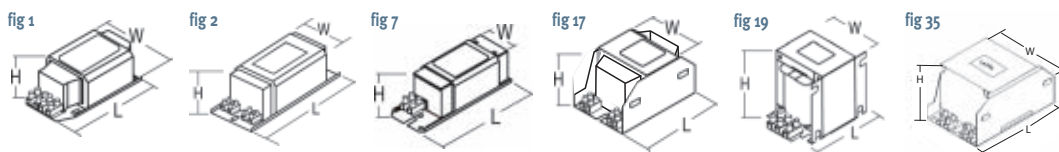

Control Gear for HPS, MH & Ceramic MH Lamps 100W 150W & 200W

Ballasts

100 - 200W

50Hz Control Gear For HPS, MH & Ceramic MH Lamps

Lamp (W)	(A)	Ballast Code (V)	Input Voltage (W)	Circuit Watts (A)	Running Current	Δt/tw (°C)	Dimensions LxWxH/Fix (mm)	Weight (kg)	TC	Fig	Capacitor μf/V	Standard Ignitor	Circuit	Timed Ignitor	Circuit
100	1.1	HSA10223221	230/240	118	0.53	75/140	120 x 69 x 56/106-111 Note ⑦	1.6	Y	17	12/250	PAE400255 PXE100255	Y Y	MCi6 PCX400255	X Y
100	1.1	HSJ10223221	230/240	118	0.53	75/140	106 x 68 x 56/88-97 Note ⑤	1.4	Y	35	12/250	PAE400255 PXE100255	Y Y	MCi6 PCX400255	X Y
100	1.1	HSP10223221	230/240	118	0.53	75/140	106 x 65 x 52/52 x 86-98	1.3	Y	2	12/250	PAE400255 PXE100255	Y Y	MCi6 PCX400255	X Y
100	1.1	HSG10322221	220/230/240/250	123	0.56	75/140	173 x 53 x 46/150-165	1.5	Y	7	12/250	PAE400255 PXE100255	N N	PCX400255	N
100	1.1	HSZ10322221	220/230/240/250	117	0.54	60/140	128 x 66 x 46/52 x 85-96	1.5	Y	1	12/250	PAE400255 PXE100255	N N	PCX400255	N
100	1.1	HSV10322221	220/230/240/250	120	0.56	75/140	94 x 75 x 63/54 x 54 Note ②	1.5	Y	19	12/250	PAE400255 PXE100255	N N	PCX400255	N
150	1.8	HSA15223221	230/240	176	0.8	75/140	120 x 69 x 56/133-141 Note ⑧	2.3	Y	17	20/250	PAE400255 PXE100255	Y Y	MCi6 PCX400255	X Y
150	1.8	HSJ15223221	230/240	176	0.8	75/140	120 x 68 x 56/106-111	1.8	Y	35	20/250	PAE400255 PXE100255	Y Y	MCi6 PCX400255	X Y
150	1.8	HSP15223221	230/240	176	0.8	75/140	135 x 65 x 52/52 x 118-127	1.8	Y	2	20/250	PAE400255 PXE100255	Y Y	MCi6 PCX400255	X Y
150	1.8	HSZ15322221	220/230/240/250	172	0.79	60/140	158 x 66 x 46/52 x 115-126	2.2	Y	1	20/250	PAE400255 PXE100255	N N	PCX400255	N
150	1.8	HSV16322221	220/230/240/250	175	0.8	75/140	125 x 78 x 65/110	2.4	Y	9	20/250	PAE400255 PBo19K255 PXE100255	N A1 N	PCX400255 PJo19K255	N A1
150	1.8	HSN155202	200/210/220/ 230/240/250 Note ①	167	0.74	50/130	133 x 108 x 109/76 x 113	4.4		5	20/250	PAE400255 PXE100255	V1 V1	PCX400255	V1
150	1.8	HSF165192	190/200/210/ 220/230/240 Note ③	175	0.8	70/130	172 x 92 x 80/150 - 160	3.4		21	20/250	PAE400255 PBo19K255 PXE100255	T1 U1 T1	PCX400255 PJo19K255	T1 U1
150/ 100	1.8	AV101523221 Note ④	230/240	175	0.8	60/140	150 x 98 x 81/135 x 76	TBA	Y	9	20/250	PAE400255 PXE100255	X1 X1	PCX400255	X1

60Hz Control Gear For HPS, MH & Ceramic MH Lamps

See Also HSN155202 & HSF165192 Above

Lamp (W)	(A)	Ballast Code	Input Voltage (V)	Circuit Watts (W)	Running Current (A)	Δt/tw (°C)	Dimensions LxWxH/Fix (mm)	Weight (kg)	TC	Fig	Capacitor μf/V	Standard Ignitor	Circuit	Timed Ignitor	Circuit
100	1.1	HSJ102222BD	220/230	118	.53	75/140	106 x 68 x 56/86-97 Note ⑤	1.4	Y	35	10/250	PAE400255 PXE100255	J1 J1	MCi6-6 PCX400255	H1 J1
100	1.1	HSP102222BD	220/230	118	.53	75/140	106 x 65 x 52/52 x 86-98	1.3	Y	2	10/250	PAE400255 PXE100255	J1 J1	MCi6-6 PCX400255	H1 J1
150	1.8	HSJ152222BD	220/230	176	0.8	75/140	136 x 68 x 56/113-125 Note ⑥	1.8	Y	35	16/250	PAE400255 PXE100255	J1 J1	MCi6-6 PCX400255	H1 J1
150	1.8	HSP152222BD	220/230	176	0.8	75/140	135 x 65 x 52/52 x 118-127	1.8	Y	2	16/250	PAE400255 PXE100255	J1 J1	MCi6-6 PCX400255	H1 J1
150	1.8	HSZ16322645	220/230/240	175	0.8	75/140	135 x 66 x 46/52 x 85-96	1.8		1	16/250	PAE400255 PXE100255	A A	PCX400255	A

50Hz Control Gear For MH Lamps

Lamp (W)	(A)	Ballast Code	Input Voltage (V)	Circuit Watts (W)	Running Current (A)	Δt/tw (°C)	Dimensions LxWxH/Fix (mm)	Weight (kg)	TC	Fig	Capacitor μf/V	Standard Ignitor	Circuit	Timed Ignitor	Circuit
200	1.6	HMA20223221	230/240	220	1.02	70/140	150 x 69 x 56/133-141 Note ⑧	2.3	Y	17	12/250	PAE400255 PXE100255	Y Y	MCi6 PCX400255	X Y
200	1.6	HMJ20223221	230/240	220	1.02	70/140	136 x 68 x 56/113-125 Note ⑥	TBA	Y	35	12/250	PAE400255 PXE100255	Y Y	MCi6 PCX400255	X Y
200	1.6	HMP20223221	230/240	220	1.02	70/140	135 x 65 x 52/52 x 118-127	1.9	Y	2	12/250	PAE400255 PXE100255	Y Y	MCi6 PCX400255	X Y
200	1.6	HMZ20322245	220/230/240	217	1.02	60/140	158 x 66 x 46/52 x 115-126	2.2		1	12/250	PAE400255 PXE100255	A A	PCX400255	A
200/ 250	1.6/ 2.1	JH202523221 Note ④	230/240	217/ 282	1.0/ 1.28	50/140 80/140	106 x 94 x 65/80 x 90	2.5	Y	3	12/250 20/250	PAE400255 PXE100255	Y1 Y1	PCX400255	Y1

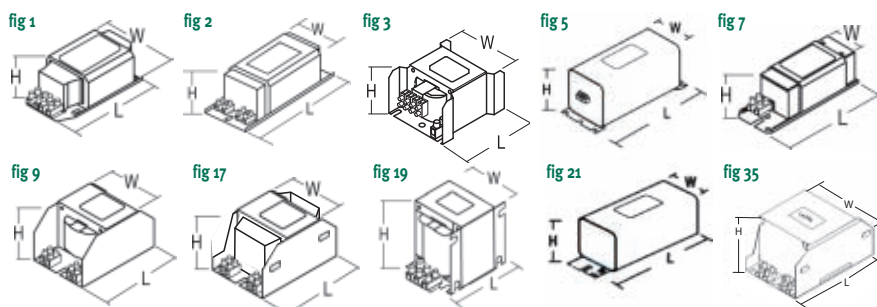

- Notes
- Note ① 220/230/240/250/260/270 for 60Hz Capacitor 16/TBA
 - Note ② Additional fixings 54 x 42 mm
 - Note ③ 210/220/230/240/250/260 for 60Hz Capacitor 16/TBA
 - Note ④ Suitable for step dimming to 100W
 - Note ⑤ Additional fixings 52 x 86 - 92 mm and side fixings 84 - 96 mm
 - Note ⑥ Additional fixings 52 x 11 - 18 mm side fixings 112 - 125 mm
 - Note ⑦ Additional fixings 53 x 96 - 109 mm side fixings 95 - 109 mm
 - Note ⑧ Additional fixings 53 x 126 - 139 mm side fixings 95 - 109 mm



40

Control Gear HPS, MH & Ceramic MH Lamps 250W

50Hz Control Gear For HPS, MH & Ceramic MH Lamps

Lamp (W)	(A)	Ballast Code	Input Voltage (V)	Circuit Watts (W)	Running Current (A)	Δt/tw (°C)	Dimensions LxWxH/Fix (mm)	Weight (kg)	TC	Fig	Capacitor μF/V	Standard Ignitor	Circuit	Timed Ignitor	Circuit
250	3.0	HSA25223221	230/240	286	1.32	75/140	167 x 87 x 72/150-160 Note ⑧	3.6	Y	17	30/250	PAE400255 PXE100255	Y Y	MCI6 PCX400255	X Y
250	3.0	HSA252232CH	230/240	286	1.32	75/140	150 x 87 x 72/133 x 143 Note ⑨	3.4	Y	17	30/250	PAE400255 PXE100255	Y Y	MCI6 PCX400255	X Y
250	3.0	HSJ25223221	230/240	286	1.32	75/140	137 x 86 x 74/116-128 Note ③	3.2	Y	35	30/250	PAE400255 PXE100255	Y Y	MCI6 PCX400255	X Y
250	3.0	HSP25223221	230/240	286	1.32	75/140	127 x 86 x 73/108-118 Note ②	2.8	Y	17	30/250	PAE400255 PXE100255	Y Y	MCI6 PCX400255	X Y
250	3.0	HSZ25322221	220/230/240/250	285	1.32	75/140	198 x 66 x 46/52 x 155-166	3.0	Y	1	30/250	PAE400255 PXE100255	N N	PCX400255	N
250	3.0	HDV26322221	220/230/240/250	285	1.32	75/140	150 x 98 x 81/135 x 76	3.6	Y	9	30/250	PAE400255 PB404K255 PXE100255	N A1 N	PCX400255 PJ404K255	N A1
250	3.0	JDV26322221	220/230/240/250	285	1.32	80/140	120 x 104 x 81/90 x 100	3.6	Y	3	30/250	PAE400255 PB404K255 PXE100255	N A1 N	PCX400255 PJ404K255	N A1
250	3.0	EAV255202	200/210/220/ 230/240/250 Note ①	275	1.26	65/140	150 x 98 x 81/135 x 76	2.3	9	30/250	PAE400255 PB404K255 PXE100255	V1 Z1 V1	PCX400255 PJ404K255	V1 Z1	
250	3.0	HDM255202	200/210/220/ 230/240/250 Note ①	275	1.26	60/130	166 x 107 x 109/146 x 76	5.0	5	30/250	PAE400255 PB404K255 PXE100255	V1 Z1 V1	PCX400255 PJ404K255	V1 Z1	
250	3.0	HDN25520221	200/210/220/ 230/240/250 Note ①	275	1.26	60/130	133 x 107 x 109/113 x 76	4.6	Y	5	30/250	PAE400255 PB404K255 PXE100255	V1 Z1 V1	PCX400255 PJ404K255	V1 Z1
250	3.0	HDN26322221	220/230/240/250	285	1.32	70/130	133 x 107 x 109/113 x 76	4.6	Y	5	30/250	PAE400255 PB404K255 PXE100255	N A1 N	PCX400255 PJ404K255	N A1
250/ 150	3.0	AV152523221 Note ③	230/240	285	1.32	60/140	150 x 98 x 81/135 x 76	4.1	Y	9	30/250	PAE400255 PXE100255	X1 X1	PCX400255	X1

60Hz Control Gear For HPS, MH & Ceramic MH Lamps

See Also EAV255202, HDM255202 & HDN25520221 Above

Lamp (W)	(A)	Ballast Code	Input Voltage (V)	Circuit Watts (W)	Running Current (A)	Δt/tw (°C)	Dimensions LxWxH/Fix (mm)	Weight (kg)	TC	Fig	Capacitor μF/V	Standard Ignitor	Circuit	Timed Ignitor	Circuit
250	3.0	HSJ252222BD	220/230	286	1.32	75/140	137 x 86 x 74/116-128 Note ③	3.2	Y	35	25/250	PAE400255 PXE100255	J1 J1	MCI6-6 PCX400255	H1 J1
250	3.0	HSP252222BD	220/230	286	1.32	75/140	127 x 86 x 73/108-118 Note ②	2.8	Y	17	25/250	PAE400255 PXE100255	J1 J1	MCI6-6 PCX400255	H1 J1

50Hz Control Gear For MH Lamps

Lamp (W)	(A)	Ballast Code	Input Voltage (V)	Circuit Watts (W)	Running Current (A)	Δt/tw (°C)	Dimensions LxWxH/Fix (mm)	Weight (kg)	TC	Fig	Capacitor μF/V	Standard Ignitor	Circuit	Timed Ignitor	Circuit
250	2.1	HMA25223221	230/240	283	1.28	70/140	127 x 87 x 72/109-119 Note ⑦	2.4	Y	17	20/250	PAE400255 PH400K255 PXE100255	Y B1 Y	MCI6 PCX400255	X Y
250	2.1	HMJ25223221	230/240	283	1.28	70/140	117 x 86 x 74/96-108 Note ④	2.3	Y	35	20/250	PAE400255 PH400K255 PXE100255	Y B1 Y	MCI6 PCX400255	X Y
250	2.1	HMP25223221	230/240	283	1.28	70/140	117 x 86 x 73/97-106 Note ②	2.0	Y	17	20/250	PAE400255 PH400K255 PXE100255	Y B1 Y	MCI6 PCX400255	X Y
250	2.1	HMZ25322245	220/230/240	282	1.28	75/140	158 x 66 x 46/52 x 115-126	2.2	1	20/250	PAE400255 PH400K255 PXE100255	A K A	PCX400255	A	
250	2.1	JHV26322221	220/230/240/250	280	1.25	75/140	106 x 94 x 65/80 x 90	2.2	Y	3	20/250	PAE400255 PB404K255 PXE100255	N A1 N	PCX400255 PJ404K255	N A1
250	2.1	MM255K202	200/210/220/ 230/240/250 Note ⑤	269	1.18	50/130	166 x 107 x 109/146 x 76	4.8	5	20/250	PAE400255 PH400K255 PXE100255	V1 A2 V1	PCX400255	V1	
250	2.1	MN255K192	190/200/210/ 220/230/240 Note ⑥	269	1.18	55/130	133 x 107 x 109/113 x 76	4.4	5	20/250	PAE400255 PH400K255 PXE100255	T1 B2 T1	PCX400255	T1	

60Hz Control Gear For HPS & MH Lamps

See Also MM255K202 & MN255K192 Above

Lamp (W)	(A)	Ballast Code	Input Voltage (V)	Circuit Watts (W)	Running Current (A)	Δt/tw (°C)	Dimensions LxWxH/Fix (mm)	Weight (kg)	TC	Fig	Capacitor μF/V	Standard Ignitor	Circuit	Timed Ignitor	Circuit
250	2.1	HMJ252222BD	220/230	283	1.28	70/140	117 x 86 x 74/96-108 Note ④	2.2	Y	35	16/250	PAE400255 PH400K255 PXE100255	J1 D2 J1	MCI6-6 PCX400255	H1 J1
250	2.1	HMP252222BD	220/230	283	1.28	70/140	117 x 86 x 73/97-106 Note ②	2.0	Y	17	16/250	PAE400255 PH400K255 PXE100255	J1 D2 J1	MCI6-6 PCX400255	H1 J1
250	2.1	HMZ25322645	220/230/240	282	1.28	75/140	158 x 66 x 46/52 x 115-126	2.2	1	16/250	PAE400255 PH400K255	A K	PCX400255	A	

Notes

Note ① 220/230/240/250/260/270 for 60Hz Capacitor 25/TBA
Note ② Additional fixings 66 x 106 - 114 mm & side fixings 96 - 114 mm
Note ③ Additional fixings 70 x 116 - 125 mm side fixings 116 - 125 mm

Note ④ Additional fixings 70 x 112 - 118 mm side fixings 113 - 125 mm
Note ⑤ 220/230/240/250/260/270 for 60Hz Capacitor 16/TBA
Note ⑥ 210/220/230/240/250/260 for 60Hz Capacitor 16/TBA

Note ⑦ Additional fixings 70 x 104 - 117 mm and side fixings 96 - 114 mm
Note ⑧ Additional fixings 70 x 147 - 160 mm and side fixings 136 - 154 mm
Note ⑨ Additional fixings 70 x 130 - 143 mm and side fixings 119 - 137 mm

See page 40 for Figs

Ballasts

250W

41

Control Gear for HPS, MH & Ceramic MH Lamps

400W

50Hz Control Gear For HPS, MH & Ceramic MH Lamps

Lamp (W)	(A)	Ballast Code	Input Voltage (V)	Circuit Watts (W)	Running Current (A)	Δt/tw (°C)	Dimensions LxWxH/Fix (mm)	Weight (kg)	TC	Fig	Capacitor μf/V	Standard Ignitor	Circuit	Timed Ignitor	Circuit
400	4.5	HAA40223221	230/240	445	2.13	75/140	150 x 108 x 91/135 x 76 Note ⑤	4.8	Y	35	40/250	PAE400255 PXE100255	Y Y	MCi6 PCX400255	X Y
400	4.5	HSJ40223221	230/240	445	2.13	75/140	167 x 86 x 74/146-158 Note ④	4.8	Y	35	40/250	PAE400255 PXE100255	Y Y	MCi6 PCX400255	X Y
400	4.5	HSP40223221	230/240	445	2.13	75/140	167 x 86 x 73/148-158 Note ②	4	Y	17	40/250	PAE400255 PXE100255	Y Y	MCi6 PCX400255	X Y
400	4.5	HSV41322221	220/230/240/250	445	2.13	75/140	150 x 98 x 81/135 x 76	4.2	Y	9	40/250	PAE400255 PB404K255 PXE100255	N A1 N	PCX400255 PJ404K255	N A1
400	4.5	JAV41322221	220/230/240/250	445	2.13	80/140	120 x 104 x 81/90 x 100	4.2	Y	3	40/250	PAE400255 PB404K255 PXE100255	N A1 N	PCX400255 PJ404K255	N A1
400	4.5	EAV405202	200/210/220/230/240/250 Note ①	445	2.13	70/140	150 x 98 x 81/135 x 76	4.3		9	40/250	PAE400255 PB404K255 PXE100255	V1 Z1 V1	PCX400255 PJ404K255	V1 Z1
400	4.5	ASM40520221	200/210/220/230/240/250 Note ①	445	2.13	55/130	166 x 107 x 109/146 x 76	5.9	Y	5	40/250	PAE400255 PB404K255 PXE100255	V1 Z1 V1	PCX400255 PJ404K255	V1 Z1
400	4.5	HSM405202	200/210/220/230/240/250 Note ①	445	2.13	50/130	166 x 107 x 109/146 x 76	5.9		5	40/250	PAE400255 PB404K255 PXE100255	V1 Z1 V1	PCX400255 PJ404K255	V1 Z1
400	4.5	HSN415202	200/210/220/230/240/250 Note ①	445	2.13	65/130	133 x 107 x 109/113 x 76	5.9		5	40/250	PAE400255 PB404K255 PXE100255	V1 Z1 V1	PCX400255 PJ404K255	V1 Z1
400	4.5	HSN41322221	220/230/240/250	445	2.13	70/130	133 x 107 x 109/113 x 76	5.0	Y	5	40/250	PAE400255 PB404K255 PXE100255	N A1 N	PCX400255 PJ404K255	N A1
400	4.5	HSN415192	190/200/210/220/230/240	445	2.13	70/130	133 x 107 x 109/113 x 76	5.0		5	40/250	PAE400255 PB404K255 PXE100255	T1 U1 T1	PCX400255 PJ404K255	T1 UI
400/250	4.5	AV254023221 Note ③	230/240	445	2.13	70/140	150 x 108 x 91/135 x 76	6.0	Y	8	40/250	PAE400255 PXE100255	X1 X1	PCX400255	X1

60Hz Control Gear For HPS, MH & Ceramic MH Lamps

See Also EAV405202, ASM40520221 & HSM405202 Above

Lamp (W)	(A)	Ballast Code	Input Voltage (V)	Circuit Watts (W)	Running Current (A)	Δt/tw (°C)	Dimensions LxWxH/Fix (mm)	Weight (kg)	TC	Fig	Capacitor μf/V	Standard Ignitor	Circuit	Timed Ignitor	Circuit
400	4.5	HAA40222BD	220/230	445	2.13	75/140	150 x 108 x 91/135 x 76 Note ⑤	4.6	Y	35	35/250	PAE400255 PXE100255	J1 J1	MCi6-6 PCX400255	H1 J1
400	4.5	HSJ40222BD	220/230	445	2.13	75/140	167 x 86 x 74/146-158 Note ④	4.8	Y	35	35/250	PAE400255 PXE100255	J1 J1	MCi6-6 PCX400255	H1 J1
400	4.5	HSP40222BD	220/230	445	2.13	75/140	167 x 86 x 73/148-158 Note ②	4	Y	17	35/250	PAE400255 PXE100255	J1 J1	MCi6-6 PCX400255	H1 J1

NOTES

- Note ① 220/230/240/250/260/270 for 60Hz Capacitor 35/TBA
- Note ② Additional fixings 66 x 148 - 154 & side 139 - 151 mm
- Note ③ Suitable for step dimming to 250W
- Note ④ Additional fixings 70 x 146 - 155 mm side fixing 146 - 155 mm
- Note ⑤ Additional side fixings 131 - 139 mm

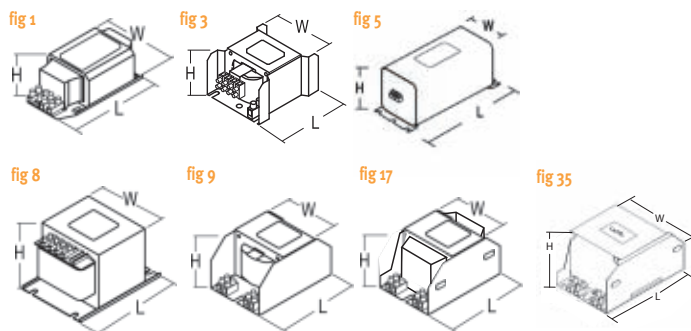

Control Gear for MH & Ceramic MH Lamps

350W 400W & 450W

Ballasts

350 - 450W

50Hz Control Gear For MH Lamps

Lamp (W)	(A)	Ballast Code	Input Voltage (V)	Circuit Watts (W)	Running Current (A)	Δt/tw (°C)	Dimensions LxWxH/Fix (mm)	Weight (kg)	TC	Fig	Capacitor μF/V	Standard Ignitor	Circuit	Timed Ignitor	Circuit
350	2.8	HMA35223221	230/240	377	1.82	70/140	167 x 87 x 72/150-160 Note ⑦	3.2	Y	35	20/250	PAE400255 PXE100255	Y Y	MCi6 PCX400255	X Y
350	2.8	HMJ35223221	230/240	377	1.82	70/140	137 x 86 x 74/116-128 Note ①	3	Y	35	20/250	PAE400255 PXE100255	Y Y	MCi6 PCX400255	X Y
350	2.8	HMP35223221	230/240	377	1.82	70/140	137 x 86 x 73/118-128 Note ⑤	2.7	Y	17	20/250	PAE400255 PXE100255	Y Y	MCi6 PCX400255	X Y
350	2.8	JHV35322245	220/230/240	374	1.82	65/140	120 x 104 x 81/90 x 100	3.5		3	20/250	PAE400255 PXE100255	N N	PCX400255	N
350/400	2.8/ 3.25	JH3540235 Note ③	230	374/ 430	1.8/ 2.0	60/140 70/140	120 x 104 x 81/90 x 100	TBA		3	20/250 25/250	PAE400255 PXE100255	E2 E2	PCX400255	E2
400	3.25	HMA40223221	230/240	430	2.01	75/140	167 x 87 x 72/150-160 Note ⑦	3.4	Y	35	25/250	PAE400255 PH400K255 PXE100255	Y B1 Y	MCi6 PCX40025	X Y
400	3.25	HMA402232CH	230/240	430	2.01	75/140	150 x 86 x 72/132-142 Note ⑧	3.5	Y	35	25/250	PAE400255 PH400K255 PXE100255	Y B1 Y	MCi6 PCX40025	X Y
400	3.25	HMJ40223221	230/240	430	2.01	75/140	137 x 86 x 74/116-128 Note ①	3.1	Y	35	25/250	PAE400255 PH400K255 PXE100255	Y B1 Y	MCi6 PCX40025	X Y
400	3.25	HMP40223221	230/240	430	2.01	75/140	137 x 86 x 73/118-128 Note ⑤	2.8	Y	17	25/250	PAE400255 PH400K255 PXE100255	Y B1 Y	MCi6 PCX40025	X Y
400	3.25	HMZ40322245	220/230/240	430	2.01	70/140	198 x 66 x 46/52 x 155-166	3.1		1	25/250	PAE400255 PH400K255 PXE100255	A K A	PCX400255	A
400	3.25	JHV413222B3	220/230/240	430	2.03	80/140	120 x 104 x 81/90 x 100	3.8	Y	3	25/250	PAE400255 PH400K255 PXE100255	A K A	PCX400255	A
400	3.25	EMV405202	200/210/220/ 230/240/250 Note ⑥	425	1.93	75/140	150 x 98 x 81/135 x 76	3.8		9	25/250	PAE400255 PB404K255 PH400K255 PXE100255	V1 Z1 A2 V1	PCX400255 PJ404K255	V1 Z1
400	3.25	MM405K202	200/210/220/ 230/240/250 Note ⑥	425	1.93	60/130	166 x 107 x 109/146 x 76	5.2		5	25/250	PAE400255 PH400K255 PXE100255	V1 A2 V1	PCX400255	V1

60Hz Control Gear For MH Lamps

See Also EMV405202 & MM405K202 Above

Lamp (W)	(A)	Ballast Code	Input Voltage (V)	Circuit Watts (W)	Running Current (A)	Δt/tw (°C)	Dimensions LxWxH/Fix (mm)	Weight (kg)	TC	Fig	Capacitor μF/V	Standard Ignitor	Circuit	Timed Ignitor	Circuit
400	3.25	HMA402222BD	220/230	430	2.01	75/140	167 x 87 x 72/150-160 Note ⑦	3	Y	35	20/250	PAE400255 PH400K255 PXE100255	J1 D2 J1	MCi6-6 PCX400255	H1 J1
400	3.25	HMJ402222BD	220/230	430	2.01	75/140	137 x 86 x 74/116-128 Note ①	3.1	Y	35	20/250	PAE400255 PH400K255 PXE100255	J1 D2 J1	MCi6-6 PCX400255	H1 J1
400	3.25	HMP402222BD	220/230	430	2.01	75/140	137 x 86 x 73/118-128 Note ⑤	2.8	Y	17	20/250	PAE400255 PH400K255 PXE100255	J1 D2 J1	MCi6-6 PCX400255	H1 J1

50Hz Control Gear For MH Lamps

Lamp (W)	(A)	Ballast Code	Input Voltage (V)	Circuit Watts (W)	Running Current (A)	Δt/tw (°C)	Dimensions LxWxH/Fix (mm)	Weight (kg)	TC	Fig	Capacitor μF/V	Standard Ignitor	Circuit	Timed Ignitor	Circuit
450	3.7	HAA40223221	230/240	477	2.28	75/140	150 x 108 x 91/135 x 76 Note ⑨	6.0	Y	35	25/250	PAE400255 PXE100255	Y Y	MCi6 PCX400255	X Y
450	3.7	HSJ40223221	230/240	477	2.28	75/140	167 x 86 x 74/146 - 158 Note ④	4.8	Y	35	25/250	PAE400255 PXE100255	Y Y	MCi6 PCX400255	X Y
450	3.7	HSP40223221	230/240	477	2.28	75/140	167 x 86 x 73/148-158 Note ②	4.0	Y	17	25/250	PAE400255 PXE100255	Y Y	MCi6 PCX400255	X Y

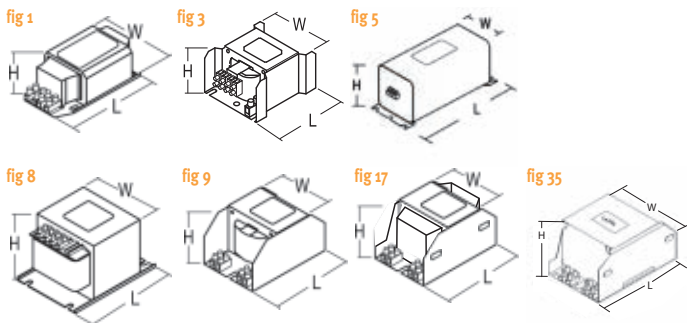

NOTES

- Note ① Additional fixings 70 x 116 - 125 mm side fixings 116 - 125 mm
- Note ② Additional fixings 66 x 148 - 154 mm & side 139 - 151 mm
- Note ③ 350W ballast with additional tapping for 400W lamps
- Note ④ Additional fixings 70 x 146 - 155 mm side fixing 146 - 155 mm
- Note ⑤ Additional fixings 66 x 116 - 124 mm & side 106 - 124 mm
- Note ⑥ 220/230/240/250/260/270 for 60Hz Capacitor 20/TBA
- Note ⑦ Additional fixings 70 x 147 - 160 mm and side fixings 136 - 154 mm
- Note ⑧ Additional fixings 70 x 126 - 140 mm and side fixings 119 - 137 mm
- Note ⑨ Additional side fixings 131 - 139 mm

Control Gear for HPS, MH Lamps

600W 875W 1000W 1500W & 2000W

50Hz Control Gear For HPS & MH Lamps

Lamp (W)	Ballast Code	Input Voltage (V)	Circuit Watts (W)	Running Current (A)	Δt/tw (°C)	Dimensions LxWxH/Fix (mm)	Weight (kg)	TC	Fig	Capacitor μF/V	Standard Ignitor	Circuit	Timed Ignitor	Circuit
600	HAA60223221	230/240	655	2.89	80/140	177 x 108 x 92/156 x 162	7.0	Y	24	60/250	PXE000255	Y	MCI-600 PCX000255	X Y
600	HAV60223221	230/240	655	2.89	80/140	150 x 108 x 91/135 x 76 Note ②	6.0	Y	24	60/250	PXE000255	Y	MCI-600 PCX000255	X Y
600	HAV603222B3	220/230/240	655	2.89	80/140	150 x 108 x 91/135 x 76	6.0	Y	8	60/250	PXE000255	A	PCX000255	A
600	HAV602232	230/240	655	2.89	80/140	150 x 108 x 91/135 x 76	6.0		24	60/250	PXE000255	Y	MCI-600 PCX000255	X Y
600	HSM605202	200/210/220/230/240/250 Note ①	655	3.1	75/130	166 x 107 x 109/146 x 76	7.6		5	60/250	PB600K255 PXE000255	F2 V1	PCX000255 PJ600K255	V1 Z1
875	SHQ877232	230/240	970	4.5	90/140	121 x 108 x 100/111 x 98	-	-	-	26/500	BVS-020	See Datasheet		
875/1000	HMP803383	380/400/415	915/1100	2.5/3.0	75/140	190 x 120 x 105/166 x 103	10		6	15/440	PXE150485	See Datasheet		
1000	HDP002232	230/240	1105	5.0	80/140	190 x 120 x 102/103 x 155 - 177 Note ⑤	9.4		6	2 x 50/250	PXE000255	Q	PCX000255 MCI-1000	Q Z
1000	HDP003212	210/220/230/240	1105	5.0	80/140	190 x 120 x 102/103 x 155 - 177 Note ⑤	9.4		6	2 x 50/250	PXE000255	Q	PCX000255	Q
1000	HDV003212	210/220/230/240	1105	5.0	80/140	177 x 150 x 126/138 x 125	10.8		6	2 x 50/250	PB000K255 PXE000255	R Q	PCX000255 PJ000K255	Q S
1000	HSV003222	220/230/240/250	1090	5.2	60/140	215 x 150 x 126/180 x 125	15.5		6	2 x 50/250	PB000K255 PXE000255	J2 N	PCX000255 PJ000K255	N A1
1000	HDF00322245	220/230/240	1105	5.0	65/130	200 x 160 x 140/180 x 125	14.0		22	2 x 50/250	PXE000255	A	PCX000255	A
1000	HSV043383	380/400/415	1090	3	60/140	215 x 150 x 126/180 x 125	16.5		6	30/440	PB500K445 PXE150485	T B	N/A	
1000	HSV043384	380/415/440	1090	3	60/140	215 x 150 x 126/180 x 125	16.5		6	30/440	PB500K445 PXE150485	L2 M2	N/A	
1000	HSV042405AD	400 Note ③	1090	3	60/140	215 x 150 x 126/180 x 125	16.5		6	30/440	PXE150485	K2	N/A	
1000	HIB00322245	220/230/240	1080	5.1	65/130	223 x 110 x 112/203 x 76	11.0		5	2 x 35/250	PH400K255 PXE000255	K A	N/A	
1000	HQV002224	220/240	1080	5.1	65/140	177 x 150 x 126/138 x 125	10.8		6	2 x 35/250	PB000K255 PH400K255 PXE000255	G2 H2 F1	PJ000K255	G1
1000	HMM043383	380/400/415	1035	2.7	70/130	166 x 107 x 109/146 x 76	7.6		5	15/440	PBA200485 PB500K445 PT150K445 PXE150485	L T B B	PCT150485	D1
1000	YHB04024521	240	1090	5.15	75/130	330 x 110 x 112/310 x 76	15.0	Y	5	15/440V Note ④	PBA200485 PT150K445	V M	PCT150485	D1
1500	HMV022383	380/400/415	1580	4.77	60/140	215 x 150 x 126/180 x 125	15.0		6	30/440	PBA200485 PT150K445	L B	PCT150485	D1
2000	HMV913222	220/230/240/250	2105	9.9	75/140	215 x 150 x 126/180 x 125	16.5		6	2 x 50/250	PH400K255 PBE900245	N2 N	N/A	
2000	HMV943383	380/400/415	2085	5.6	65/140	215 x 150 x 126/180 x 125	16.5		6	40/440	PBA200485 PB500K445 PXE150485	L T B	PCX150485	B
2000	HZP944384V2	380/400/415/430	2105	6	75/140	277 x 124 x 103/250 - 262 Note ⑤	15.8		33	45/440	PB500K445 PT150K445 PXE150485	C1 D1 D1	PCX150485 PCT150485	B D1
2000	HZV943383	380/400/415	2105	6	75/140	215 x 150 x 126/180 x 125	16.5		6	45/440	PB500K445 PT150K445 PXE150485	T B B	PCX150485 PCT150485	B D1
2000	HZV944384V2	380/400/415/430	2105	6	75/140	215 x 150 x 126/180 x 125	16.5		6	45/440	PB500K445 PT150K445 PXE150485	C1 D1 D1	PCX150485 PCT150485	B D1

60Hz Control Gear For HPS & MH Lamps

See Also HSM605202 & HSV042405AD Above

Lamp (W)	Ballast Code	Input Voltage (V)	Circuit Watts (W)	Running Current (A)	Δt/tw (°C)	Dimensions LxWxH/Fix (mm)	Weight (kg)	TC	Fig	Capacitor μF/V	Standard Ignitor	Circuit	Timed Ignitor	Circuit
600	HAV602222BD	220/230	655	2.89	80/140	150 x 108 x 91/135 x 76 Note ②	6.0	Y	24	50/250	PXE000255	J1	MCI6-6	H1
1000	HDV00322645	220/230/240	1105	5.0	80/140	177 x 150 x 126/138 x 125	10.8		6	2 x 40/250	PXE000255	A	N/A	
2000	HMV913222E6	220/230/240/250	2105	9.9	75/140	215 x 150 x 126/180 x 125	16.5		6	2 x 40/250	PH400K255 PBE900255	N2 N	N/A	
2000	HZV940446	440	2105	6	75/140	215 x 150 x 126/180 x 125	16.5		6	40/440	PT150K445 PXE150485	P2 P2	PCT150485	D1

Notes

Note ① 220/230/240/250/260/270 for 60Hz Capacitor 50/TBA Note ② Additional side fixings 131 - 139 mm Note ③ 480V 60Hz Capacitor 25/TBA Note ④ Essential Capacitor Note ⑤ Additional fixings 103 x 243 - 261 mm

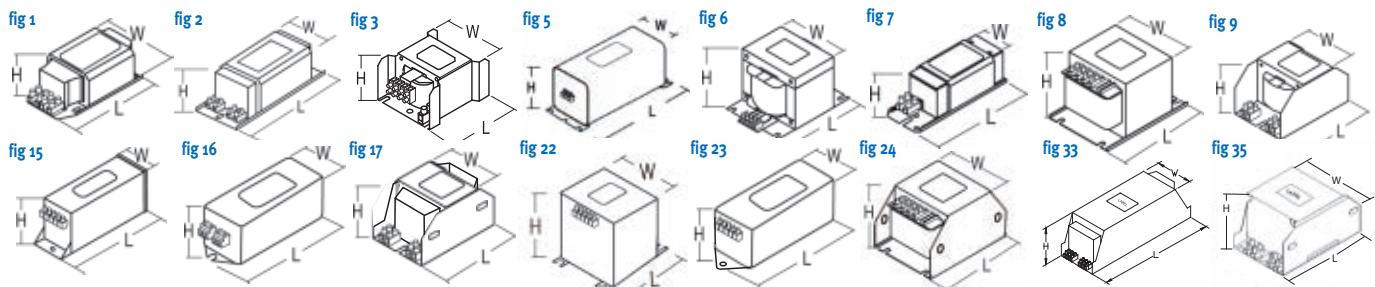

Control Gear for Mercury Lamps /SOX Lamps

50W - 1000W /35W - 135W

50Hz Control Gear For Mercury Lamps

Lamp (W)	(A)	Ballast Code	Input Voltage (V)	Circuit Watts (W)	Running Current (A)	Δt/tw (°C)	Dimensions LxWxH/Fix (mm)	Weight (kg)	TC	Fig	Capacitor μf/V	Standard Ignitor	Circuit	Timed Ignitor	Circuit
50	0.62	MP052K232	230/240	63	0.29	65/140	106 x 65 x 52/52 x 86-98	0.7		2	6/250	N/A	Z	N/A	
50	0.62	MGO53K22245	220/230/240	63	0.30	65/140	173 x 53 x 46/150-165	0.9		7	6/250	N/A	G	N/A	
50	0.62	MZ053K22245	220/230/240	63	0.29	60/140	100 x 66 x 46/52 x 57-68	0.9		1	6/250	N/A	G	N/A	
80	0.8	MP082K232	230/240	95	0.43	65/130	106 x 65 x 52/52 x 86 - 98	1.0		2	8/250	N/A	Z	N/A	
80	0.8	MGO83K22245	220/230/240	96	0.43	75/140	173 x 53 x 46/150-165	1.0		7	8/250	N/A	G	N/A	
80	0.8	MZ083K22245	220/230/240	94	0.43	55/140	100 x 66 x 46/52 x 57-68	1.0		1	8/250	N/A	G	N/A	
125	1.15	MP127K232	230/240	144	0.65	70/140	106 x 65 x 52/52 x 86-98	1.1		2	10/250	N/A	Z	N/A	
125	1.15	MG128B22245	220/230/240	145	0.66	75/140	153 x 53 x 46/131-146	1.2		7	10/250	N/A	G	N/A	
125	1.15	MZ128K22245	220/230/240	143	0.65	60/140	118 x 66 x 46/52 x 75-86	1.4		1	10/250	N/A	G	N/A	
250	2.1	HMJ25223221	230/240	283	1.28	70/140	117 x 86 x 74/96-108 Note ⑦	2.3	Y	35	20/250	N/A	Z	N/A	
250	2.1	HMP25223221	230/240	283	1.28	70/140	117 x 86 x 73/97-106 Note ②	2.0	Y	2	20/250	N/A	Z	N/A	
250	2.1	HMZ25322245	220/230/240	282	1.28	75/140	158 x 66 x 46/52 x 115-126	2.2		1	20/250	N/A	G	N/A	
250	2.1	JHV26322221	220/230/240/250	280	1.25	75/140	106 x 94 x 65/80 x 90	2.2	Y	3	20/250	N/A	W	N/A	
250	2.1	MM255K202	200/210/220/230/240/250 Note ①	269	1.18	50/130	166 x 107 x 109/146 x 76	4.8		5	20/250	N/A	Q2	N/A	
250	2.1	MN255K192	190/200/210/220/230/240 Note ③	269	1.18	55/130	133 x 107 x 109/113 x 76	4.4		5	20/250	N/A	S2	N/A	
400	3.25	HMJ40223221	230/240	430	2.01	75/140	137 x 86 x 74/116-128 Note ⑧	3.1	Y	35	25/250	N/A	Z	N/A	
400	3.25	HMP40223221	230/240	430	2.01	75/140	137 x 86 x 73/118-128 Note ④	2.8	Y	17	25/250	N/A	Z	N/A	
400	3.25	HMZ40322245	220/230/240	430	2.01	70/140	198 x 66 x 46/52 x 155-166	3.1		1	25/250	N/A	G	N/A	
400	3.25	JHV413222B3	220/230/240	430	2.03	80/140	120 x 104 x 81/90 x 100	3.8	Y	3	25/250	N/A	G	N/A	
400	3.25	EMV405202	200/210/220/230/240/250 Note ⑤	425	1.93	75/140	150 x 98 x 81/135 x 76	3.8		9	25/250	N/A	Q2	N/A	
400	3.25	MM405K202	200/210/220/230/240/250 Note ⑤	425	1.93	60/130	166 x 107 x 109/146 x 76	5.2		5	25/250	N/A	Q2	N/A	
1000	7.5	MM003K222	220/230/240/250	1040	5.0	75/130	166 x 107 x 109/146 x 76	7.6		5	50/250	N/A	U	N/A	
1000	4.1	HMM043383	380/400/415	1035	2.7	70/130	166 x 107 x 109/146 x 76	7.6		5	15/440	N/A	H	N/A	

Control Gear For Sox lamps

Lamp (W)	(A)	Ballast Code	Input Voltage (V)	Circuit Watts (W)	Running Current (A)	Δt/tw (°C)	Dimensions LxWxH/Fix (mm)	Weight (kg)	TC	Fig	Capacitor μf/V	Standard Ignitor	Circuit	Timed Ignitor	Circuit
35	0.6	RSM035245	240	50	0.23	45 ta	165 x 60 x 48/152	1.8		16	8/250	Integral	E	N/A	N/A
35/55	0.6/0.59	SZ355K245	240	48/68	0.22/0.31	70/140	118 x 66 x 46/52 x 75-86	1.0		1	8/250 6/250	PB035K245	C	PB055K245	C
35/55	0.6/0.59	SG355B245	240	50/69	0.23/0.32	60/140	153 x 53 x 46/131-146	0.8		7	8/250 6/250	PB035K245	C	PB055K245	C
35/55	0.6/0.59	RSD355245	240	50/69	0.23/0.32	50 ta	144 x 65 x 51/130	1.3		23	8/250 6/250	N/A	Integral	Integral	S1
35/55	0.6/0.59	RSF355245	240	50/69	0.23/0.32	70 tc	159 x 50 x 67/146	1.8		15	8/250 6/250	N/A	Integral	Integral	D
35/55	0.6/0.59	RSL355245	240	50/69	0.23/0.32	45 tc	165 x 76 x 54/152	2.0		16	8/250 6/250	N/A	Integral	Integral	E
90	0.94	SZ090K245	240	104	0.48	65/140	118 x 66 x 46/52 x 75-86	1.3		1	8/250	N/A	PB090K245	PB090K245	C
90	0.94	SG090B245	240	105	0.49	65/140	153 x 53 x 46/131-146	1.3		7	8/250	N/A	PB090K245	PB090K245	C
90	0.94	RSL090245	240	106	0.49	45 ta	165 x 76 x 54/152	2.2		16	8/250	N/A	Integral	Integral	E
90	0.94	SL093K222	220/230/240/250	125	0.58	65/130	178 x 99 x 74/162	4.8		16	25/250	N/A	R1	N/A	
135	0.95	RSA135245	240	175	0.88	35 ta	224 x 76 x 59/210	3.9		16	20/250	Integral	E	N/A	
135/180	0.95/0.91	SM138K222	220/230/240/250	175/225	0.84/1.04	70/130	166 x 107 x 109/146 x 76	7.4		5	15/440 Note ⑥	N/A	F	N/A	

See page 44 for Figs

Notes

- Note ① 220/230/240/250/260/270 for 60Hz Capacitor 16/TBA
- Note ② Additional fixings 66 x 106 - 114 mm & side 96 - 114 mm
- Note ③ 210/220/230/240/250/260 for 60Hz Capacitor 16/TBA
- Note ④ Additional fixings 66 x 116 - 124 & side 106 - 124 mm
- Note ⑤ 220/230/240/250/260/270 for 60Hz Capacitor 20/TBA
- Note ⑥ Essential Capacitor
- Note ⑦ Additional fixings 52 x 112 - 118 mm side fixings 113 - 125 mm
- Note ⑧ Additional fixings 70 x 116 - 125 mm side fixings 116 - 125 mm
- (ta) Maximum Ambient temperature
- (tc) Maximum Case temperature

Control Gear for CWA ,MH, Other Lamps, Lamp Detecting Device & Auto transformers

Control Gear For CWA MH Lamps

Lamp (W)	(A)	Ballast Code	Input Voltage (V)	Circuit Watts (W)	Running Current (A)	Δt/tw (°C)	Dimensions LxWxH/Fix (mm)	Weight (kg)	TC	Fig	Capacitor μF/V	Standard Ignitor	Circuit	Timed Ignitor	Circuit
175	1.5	HMZ17822245	220/230/240	197	0.91	55/140	137 x 66 x 46/52 x 118 - 126	2.2		1	20/250	PAE400255 PH400K255	A K	PCX400255	A
250	2.1	SHQ250115	110	289	2.9	80/140	150 x 94 x 130/62 x 135	3-75		4	17.5/450	N/A	See Datasheet		
400	3.25	SHQ400115	110	455	4-35	80/140	150 x 100 x 130/77 x 135	4-75		4	28/450	N/A	See Datasheet		
400	3.25	SHW40322245	220/230/240	465	2.0	85/140	159 x 118 x 93/135 x 99	7-5		4	25/440 Note ④	N/A	J	N/A	

Special Control Gear for IWASAKI Lamps & Cold Cathode Lamps

Lamp (W)	(A)	Ballast Code	Input Voltage (V)	Circuit Watts (W)	Running Current (A)	Δt/tw (°C)	Dimensions LxWxH/Fix (mm)	Weight (kg)	TC	Fig	Capacitor μF/V	Standard Ignitor	Circuit	Timed Ignitor	Circuit
100	1.5	AIZ100205 Note ①	200	116	1.02	65/140	128 x 66 x 46/52 x 85-96	1.6		1	20/250 Note ④	PIE150205	N1	N/A	
100	1.5	YAZ10024521	240	120	0.4	60/140	198 x 66 x 46/52 x 155 - 166	2.1	Y	18	20/250 Note ④	PIE150205	P	N/A	
150	1.9	AIZ150205 Note ②	200	166	1.02	75/140	137 x 66 x 46/52 x 115 - 126	1.8		1	25/250 Note ④	PIE150205	C2	N/A	
150	1.9	YAZ15024521	240	173	0.78	70/140	215 x 66 x 46/52 x 155-166	2.4	Y	18	25/250 Note ④	PIE150205	P	N/A	
N/A	0.45	CGN450850	240	N/A	N/A	N/A	185 x 103 x 78/165 x 76	5		5	-	N/A	R2	N/A	

Lamp Detecting Device

Auxiliary Lamp (W)	(A max)	Product Code	Input Voltage (V)	Circuit Watts (W)	Running Current (A)	Δt/tw (°C)	Dimensions Ø x L/Fix (mm)	Weight (kg)	TC	Fig	Max Ignition Pulse (kV)	Internal Temperature (°C)	Circuit
50-500	2.1	LDD500255	240	-	-	85tc	45 x 102/ M8 x 10	0.25	-	26	5.0	25	T2 Note ⑤

Auto Transformers

VA	Product Code	Voltage Input - Output (V)	Dimension LxWxH/Fix (mm)	Weight (kg)	Thermal Cut-out	Fig
120	XNG220240J8	220/230 - 240	92 x 53 x 46/76 x 86	0.5		7
120	XNZ220200M1	220/230/ 240 - 200	100 x 66 x 46/52 x 57-68	0.4	Y	1
200	XCG100240	100 - 240	173 x 53 x 46/150-165	1.45		7
200	XCZ23020021	230 - 200	100 x 66 x 46/52 x 57-68	0.45	Y	1
500	XEM11024021	110 - 240	166 x 107 x 109/146 x 76	5.2	Y	5
500	XEM120240	120 - 240	166 x 107 x 109/146 x 76	5.2		5
500	XEN38024022	380/480 - 240	133 x 107 x 109/113 x 76	4.8	Y	5
500	XEV110220AR	110 - 220	150 x 98 x 81/135 x 76	3.6	Y Note ③	9
500	XEV110240	110 - 240	150 x 98 x 81/135 x 76	3.6		9
500	XEV12022021	120 - 220	150 x 98 x 81/135 x 76	3.6		9
1250	XFM110240	110 - 240	166 x 107 x 109/146 x 76	9.5		5
1250	XFM24041521	240 - 415	166 x 107 x 109/146 x 76	7.5		5
1250	XFV110220AR	110 - 220	158 x 98 x 112/135 x 76	8.3	Y Note ③	36
1500	XGV480240	480 - 240	215 x 150 x 126/180 x 125	15.5		6

All transformers are designed to operate with suitable power factor correction capacitors in circuit

Notes

- Note ① For use with XNZ220200M1 Transformer
- Note ② For use with XCZ23020021 Transformer
- Note ③ Non resetting thermal cutout fitted
- Note ④ Essential Capacitor
- Note ⑤ Other Circuits on Request

(tc) Maximum Case temperature

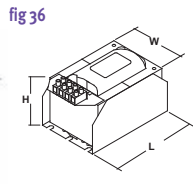
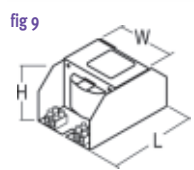
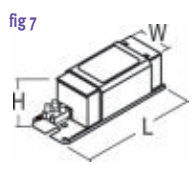
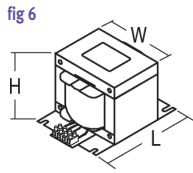
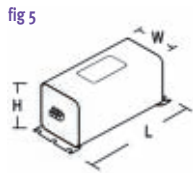
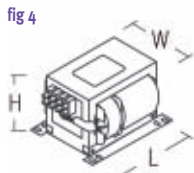
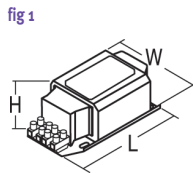

High Power Factor Conversion Kits

200w Resin Filled with Ignitor and Capacitor

Part No	Fitting Type	Kit Description	Ballast	Ignitor	Capacitor	Lamp	Fig
IBM-200WCONKIT-00247	Open rated	HIPT 200W/H75/UVS/T52/PS/4K KIT	IBM200245CU	INT	INT	00247	38
IBM-200WCONKIT-00285	Enclosed rated	HIT 200W/H75/PS/4K KIT	IBM200245CU	INT	INT	00285	38
IBM-200WCONKIT-10058	Enclosed rated	HIE 200W/C/U/PS/4K KIT	IBM200245CU	INT	INT	10058	38
IBM-200WCONKIT-10059	Open rated	HIPE 200W/C/V/UVS/PS/4K KIT	IBM200245CU	INT	INT	10059	38
IMB-200WCONKIT-10067	Open rated	HIPE 200W/V/PS/4K KIT	IBM200245CU	INT	INT	10067	38
IBM-200WCONKIT-88247	Enclosed rated	HIE 200W/U/PS/4K KIT	IBM200245CU	INT	INT	88247	38

200w Magnetic Loose Gear

Part No	Fitting Type	Kit Description	Ballast	Ignitor	Capacitor	Lamp	Fig
200WCONKIT-00247	Open rated	HIPT 200W/H75/UVS/T52/PS/4K KIT	HMP20223221	MCI6	R1008HP120P25	00247	2
200WCONKIT-00285	Enclosed rated	HIT 200W/H75/PS/4K KIT	HMP20223221	MCI6	R1008HP120P25	00285	2
200WCONKIT-10058	Enclosed rated	HIE 200W/C/U/PS/4K KIT	HMP20223221	MCI6	R1008HP120P25	10058	2
200WCONKIT-10059	Open rated	HIPE 200W/C/V/UVS/PS/4K KIT	HMP20223221	MCI6	R1008HP120P25	10059	2
200WCONKIT-10067	Open rated	HIPE 200W/V/PS/4K KIT	HMP20223221	MCI6	R1008HP120P25	10067	2
200WCONKIT-88247	Enclosed rated	HIE 200W/U/PS/4K KIT	HMP20223221	MCI6	R1008HP120P25	88247	2

350w Resin Filled with Internal Ignitor and Capacitor

Part No	Fitting Type	Kit Description	Ballast	Ignitor	Capacitor	Lamp	Fig
IBM-350WCONKIT-00248	Open rated	HIPT 350W/H75/UVS/T52/PS/4K KIT	IBM350245CU	INT	INT	00248	38
IBM-350WCONKIT-00283	Enclosed rated	HIT 350W/H75/PS/4K KIT	IBM350245CU	INT	INT	00283	38
IBM-350WCONKIT-10056	Enclosed rated	HIE 350W/C/V/PS/4K KIT	IBM350245CU	INT	INT	10056	38
IBM-350WCONKIT-10057	Open rated	HIPE 350W/C/V/UVS/PS/4K KIT	IBM350245CU	INT	INT	10057	38
IBM-350WCONKIT-10068	Open rated	HIPE 350W/V/PS/4K KIT	IBM350245CU	INT	INT	10068	38
IBM-350WCONKIT-96307	Enclosed rated	HIE 350W/H75/PS/4K KIT	IBM350245CU	INT	INT	96307	38
IBM-350WCONKIT-20138	Enclosed rated	HIE 350W/V/PS/4K KIT	IBM350245CU	INT	INT	20138	38

350w Magnetic Loose Gear

Part No	Fitting Type	Kit Description	Ballast	Ignitor	Capacitor	Lamp	Fig
350WCONKIT-00248	Open rated	HIPT 350W/H75/UVS/T52/PS/4K KIT	HMP35223221	MCI6	R1008HP200P25M	00248	17
350WCONKIT-00283	Enclosed rated	HIT 350W/H75/PS/4K KIT	HMP35223221	MCI6	R1008HP200P25M	00283	17
350WCONKIT-10056	Enclosed rated	HIE 350W/C/V/PS/4K KIT	HMP35223221	MCI6	R1008HP200P25M	10056	17
350WCONKIT-10057	Open rated	HIPE 350W/C/V/PS/4K KIT	HMP35223221	MCI6	R1008HP200P25M	10057	17
350WCONKIT-10068	Open rated	HIPE 350W/V/PS/4K KIT	HMP35223221	MCI6	R1008HP200P25M	10068	17
350WCONKIT-96307	Enclosed rated	HIE 350W/H75/PS/4K KIT	HMP35223221	MCI6	R1008HP200P25M	96307	17
350WCONKIT-20138	Enclosed rated	HIE 350W/V/PS/4K KIT	HMP35223221	MCI6	R1008HP200P25M	20138	17

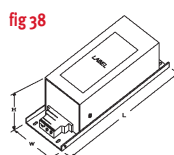
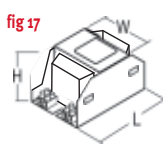
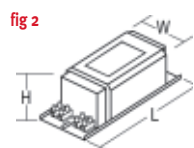

Ignitors

Wattage (W)	Ignitor Code	Timed	Ignitor Type	Max Lamp Current	Pulse Magnitude (A)	Dimensions Ø/LxWxH (kV)	Fixing (mm)	Weight (kg)	Max. Lead Capacitance	Max Case Temp (pF)	Internal Temp (°C)	Fig (°C)
MCI Series Ignitors 220/240V ±10% 50Hz												
35-600	MCI6	Y	Semi-Parallel	N/A	3.0-4.5	50 x 25 x 17	M8 x 10	0.08	1000 Note ②	105	N/A	14
50/70	MCI57	Y	Semi-Parallel	N/A	1.8-2.5	50 x 25 x 17	M8 x 10	0.08	100	105	N/A	14
600	MCI-600	Y	Semi-Parallel	N/A	4.0-5.0	50 x 25 x 17	M8 x 10	0.08	1000	105	N/A	14
1000	MCI-1000	Y	Semi-Parallel	N/A	3.0-5.0	39 x 71	M8 x 10	0.14	10000	105	N/A	11
MCI Series Ignitors 220/240V ±10% 60Hz												
35-600	MCI6-6	Y	Semi-Parallel	N/A	3.0-4.5	50 x 25 x 17	M8 x 10	0.08	1000	105	N/A	14
Standard Ignitors 220/240V ±10% 50/60Hz												
35-70	PXE070255	N	Superimposed	2	1.8-2.3	71 x 33 x 31	M8 x 10	0.18	200	90	20	10
35-450	PXE100255	N	Superimposed	5	3.5-4.5	71 x 33 x 31	M8 x 10	0.18	100	105	30	10
35-450	PAE400255	N	Superimposed	5	3.5-4.5	39 x 71	M8 x 10	0.18	100	105	30	11
35-450	PLE400255	N	Superimposed	5	3.0-4.5	127 x 50	M8 x 10	0.25	1000	90	30	11
600-1000	PXE000255	N	Superimposed	11	3.5-5.0	90 x 49 x 50	M8 x 10	0.45	100	105	25	10
2000	PBE900245	N	Superimposed	18	3.0-4.5	62 x 142	M12 x 13	0.93	200	90	20	11
50-70	PB070K255	N	Impulser	N/A	1.8-2.3	39 x 71	M8 x 10	0.14	2500	85	N/A	11
150	PB019K255	N	Impulser	N/A	3.0-4.5	39 x 71	M8 x 10	0.14	3000	85	N/A	11
250-400	PB404K255	N	Impulser	N/A	3.0-4.5	39 x 71	M8 x 10	0.14	3000	85	N/A	11
600	PB600K255	N	Impulser	N/A	3.0-4.5	52 x 115	M8 x 10	0.38	3000	85	N/A	11
1000	PB000K255	N	Impulser	N/A	3.0-4.5	52 x 115	M8 x 10	0.38	5000	85	N/A	11
250-2000	PH400K255	N	2 Wire Parallel	N/A	0.75-0.9	30 x 65	M8 x 10	0.08	20000	85	N/A	13
Standard Ignitors 380/440V ±10% 50/60Hz												
1000-2000	PT150K445	N	Superimposed	12	5.0-6.0	51 x 110	M8 x 10	0.45	200	90	25	11
600-2000	PXE150485	N	Superimposed	11	4.0-5.0	90 x 49 x 50	M8 x 10	0.45	150	90	25	10
3500	PBE350485	N	Superimposed	18	4.0-5.0	62 x 142	M12 x 13	0.96	200	90	20	11
600-2000	PB500K445	N	Impulser	N/A	3.0-5.0	52 x 115	M8 x 10	0.38	5000	85	N/A	11
1000-2000	PBA200485	N	2 Wire Parallel	N/A	1.0-1.5	51 x 110	M8 x 10	0.34	10000	85	N/A	13
Timed Ignitors 220/240V ±10% 50/60Hz												
35-70	PCX070255	Y	Superimposed	2	1.8-2.3	40 x 75	M8 x 10	0.18	200	105	20	11
35-450	PCX400255	Y	Superimposed	5	3.5-4.5	40 x 75	M8 x 10	0.18	100	105	30	11
600-1000	PCX000255	Y	Superimposed	12	3.5-5.0	60 x 93	M12 x 13	0.51	100	105	30	11
70	PJ070K255	Y	Impulser	N/A	1.8-2.3	39 x 71	M8 x 10	0.14	2500	90	N/A	11
150	PJ019K255	Y	Impulser	N/A	3.0-4.5	39 x 71	M8 x 10	0.14	3000	90	N/A	11
250-400	PJ404K255	Y	Impulser	N/A	3.0-4.5	39 x 71	M8 x 10	0.14	3000	90	N/A	11
600	PJ600K255	Y	Impulser	N/A	3.0-4.5	39 x 71	M8 x 10	0.14	2500	90	N/A	11
1000	PJ000K255	Y	Impulser	N/A	3.0-4.5	39 x 71	M8 x 10	0.14	2500	90	N/A	11
Timed Ignitors 380/440V ±10% 50/60Hz												
1000-2000	PCT150445	Y	Superimposed	11	5.0-6.0	60 x 93	M12 x 13	0.51	100	90	25	11
ATEX Approved Ignitors 220/240V ±10% 50/60Hz												
35-70	PXA070255	N	Superimposed	2	1.8-2.3	78 x 39 x 36	M8 x 10	0.14	200	90	20	10
35-150	PXA100255	N	Superimposed	5	3.5-4.0	78 x 39 x 36	M8 x 10	0.14	100	105	15	10
70-400	PXA400255	N	Superimposed	5	3.5-4.5	45 x 95	M8 x 10	0.25	100	90	30	11
600-1000	PXA000255	N	Superimposed	11	3.5-5.0	90 x 49 x 50	M8 x 10	0.45	100	105	25	10
35-70	PCA070255	Y	Superimposed	2	1.8-2.3	102 x 46 x 40	M8 x 10	0.25	200	90	20	10
35-150	PCA100255	Y	Superimposed	2	3.5-4.0	102 x 46 x 40	M8 x 10	0.25	100	90	20	10
70-400	PCA400255	Y	Superimposed	5	3.5-4.5	102 x 46 x 40	M8 x 10	0.25	100	90	30	10
Ignitors 240V ±6% 50/60Hz for SOX lamps												
35	PB035K245	N	2 Wire Parallel	N/A	0.7-0.9	30 x 65	M8 x 10	0.08	5000	85	N/A	13
35-55	PB055K245	Y	2 Wire Parallel	N/A	0.7-1.0	45 x 75	M8 x 10	0.2	5000	85	N/A	13
90	PB090K245	Y	2 Wire Parallel	N/A	0.7-1.0	45 x 75	M8 x 10	0.2	5000	85	N/A	13
Ignitor 200V ±6% 50/60Hz for SDX lamps												
70-150	PIE150205	N	Superimposed	2	1.8-2.5	71 x 33 x 31	M8 x 10	0.15	200	90	20	11

fig 10

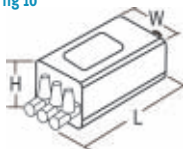

fig 11

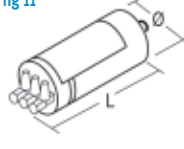

fig 13

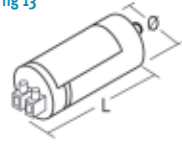
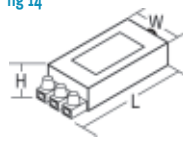

fig 14



Notes

- Note ① Suitable for 220V
- Note ② For 600W HPS maximum lead capacitance 100pF

Capacitors

250V Grip Wire Plastic Case M8 x 12 stud fixing

Value (uF)	Tolerance	Product Type	Dimensions	Fig	Order Code Dia x L. (mm)	Box	Quantity
4.0	±10%	4/250	25 x 52	28	R1008CR040P25	165	
5.0	±10%	5/250	25 x 52	28	R1008CR050P26	110	
6.0	±10%	6/250	25 x 70	28	R1008CR060P25	165	
8.0	±10%	8/250	30 x 74	28	R1008CR080P25	110	
10.0	±10%	10/250	30 x 74	28	R1008CR100P25	110	
12.0	±10%	12/250	30 x 74	28	R1008CR120P25	110	
16.0	±10%	16/250	35 x 74	28	R1008CR160P25	85	
20.0	±10%	20/250	40 x 70	28	R1008CR200P25	85	
25.0	±10%	25/250	35 x 98	28	R1008CR250P25	85	
30.0	±10%	30/250	40 x 94	28	R1008CR300P25	65	
40.0	±10%	40/250	50 x 98	28	R1008CR400P25	65	

250V Grip Wire Plastic Case Snap-in fixing

Value (uF)	Tolerance	Product Type	Dimensions	Fig	Order Code Dia x L. (mm)	Box	Quantity
4.0	±10%	4/250	25 x 52	30	R1FRLCR040P25	140	
6.0	±10%	6/250	25 x 70	30	R1FRLCR060P25	140	
8.0	±10%	8/250	30 x 74	30	R1FRLCR080P25	110	
12.0	±10%	12/250	30 x 74	30	R1FRLCR120P25	110	

250V Grip Wire Alluminium Case M8 x 12 stud fixing

Value (uF)	Tolerance	Product Type	Dimensions	Fig	Order Code Dia x L. (mm)	Box	Quantity
2.0	±10%	2/250	25 x 58	27	R1008CR020A25	165	
4.0	±10%	4/250	25 x 58	27	R1008CR040A25	165	
6.0	±10%	6/250	25 x 76	27	R1008CR060A25	165	
8.0	±10%	8/250	30 x 76	27	R1008CR080A25	110	
10.0	±10%	10/250	30 x 76	27	R1008CR100A25	110	
12.0	±10%	12/250	30 x 76	27	R1008CR200A25	85	
30.0	±10%	30/250	40 x 100	27	R1008CR300A25	65	
40.0	±10%	40/250	50 x 100	27	R1008CR400A25	65	

250V 300mm Leads Plastic Case M8 x 12 stud fixing

Value (uF)	Tolerance	Product Type	Dimensions	Fig	Order Code Dia x L. (mm)	Box	Quantity
1.5	±10%	1.5/250	25 x 52	27	R1008HP015P25	165	
2.0	±10%	2.0/250	25 x 52	27	R1008HP020P25	165	
3.0	±10%	3.0/250	25 x 52	27	R1008HP030P25	165	
4.0	±10%	4.0/250	25 x 52	27	R1008HP040P25	165	
5.0	±10%	5.0/250	25 x 70	27	R1008HP050P25	165	
5.5	±10%	5.5/250	25 x 70	27	R1008HP055P25	165	
6.0	±10%	6.0/250	25 x 70	27	R1008HP060P25	165	
7.0	±10%	7.0/250	25 x 70	27	R1008HP070P25	165	
7.2	±10%	7.2/250	30 x 74	27	R1008HP072P25	165	
8.0	±10%	8.0/250	30 x 74	27	R1008HP080P25	110	
8.4	±10%	8.4/250	30 x 74	27	R1008HP084P25	110	
10.0	±10%	10./250	30 x 74	27	R1008HP100P25M	110	
12.0	±10%	12/250	30 x 74	27	R1008HP120P25	110	
14.0	±10%	14/250	35 x 74	27	R1008HP140P25	85	
15.0	±10%	15/250	35 x 74	27	R1008HP150P25	85	
16.0	±10%	16/250	35 x 74	27	R1008HP160P25	85	
18.0	±10%	18/250	35 x 74	27	R1008HP180P25	85	
20.0	±10%	20/250	35 x 98	27	R1008HP200P25M	65	
25.0	±10%	25/250	35 x 98	27	R1008HP250P25	85	
30.0	±10%	30/250	40 x 94	27	R1008HP300P25M	65	
35.0	±10%	35/250	40 x 94	27	R1008HP350P25	65	
40.0	±10%	40/250	50 x 98	27	R1008HP400P25	65	
45.0	±10%	45/250	50 x 98	27	R1008HP450P25	40	
50.0	±10%	50/250	50 x 98	27	R1008HP500P25	40	
55.0	±10%	55/250	50 x 98	27	R1008HP550P25	35	
60.0	±10%	60/250	50 x 98	27	R1008HP600P25	40	

Continued on page 50

fig 27



fig 28



fig 30



fig 37

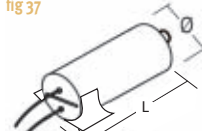

Capacitors

250V 300mm Leads Plastic Case Snap-in fixing

Value (uF)	Tolerance	Product Type	Dimensions	Fig	Order Code Dia x L. (mm)	Box	Quantity
4.0	±10%	4/250	25 x 52	37	RIFRLHP040P25	165	
6.0	±10%	6/250	25 x 70	37	RIFRLHP060P25	140	
8.0	±10%	8/250	30 x 74	37	RIFRLHP080P25	110	
12.0	±10%	12/250	30 x 74	37	RIFRLHP120P25	110	

250V 300mm Leads Aluminium Case M8 x 12 stud fixing

Value (uF)	Tolerance	Product Type	Dimensions	Fig	Order Code Dia x L. (mm)	Box	Quantity
2.0	±10%	2/250	25 x 58	27	R1008HP020A25	165	
4.0	±10%	4/250	25 x 58	27	R1008HP040A25	165	
6.0	±10%	6/250	25 x 76	27	R1008HP060A25	165	
8.0	±10%	8/250	30 x 76	27	R1008HP080A25	110	
10.0	±10%	10/250	30 x 76	27	R1008HP100A25	110	
20.0	±10%	12/250	36 x 76	27	R1008HP200A25	65	
30.0	±10%	30/250	40 x 100	27	R1008HP300A25	65	
40.0	±10%	40/250	50 x 100	27	R1008HP400A25	65	

450V 300mm Leads Plastic Case M8 x 12 stud fixing

Value (uF)	Tolerance	Product Type	Dimensions	Fig	Order Code Dia x L. (mm)	Box	Quantity
6.8	±10%	6.8/450	30 x 74	27	R1008HP068P45	85	
7.2	±10%	7.2/450	35 x 74	27	R1008HP072P45	85	
8.4	±10%	8.4/450	35 x 74	27	R1008HP084P45	85	
12.0	±10%	12/450	35 x 98	27	R1008HP120P45	85	
15.0	±10%	15/450	40 x 94	27	R1008HP150P45	85	
18.0	±10%	18/450	40 x 94	27	R1008HP180P44RE	85	
20.0	±10%	20/450	50 x 98	27	R1008HP200P45	65	
25.0	±10%	25/450	50 x 98	27	R1008HP250P45	65	
30.0	±10%	30/450	50 x 98	27	R1008HP300P45	40	
40.0	±10%	40/450	55 x 120	27	R1008HP400P40	30	
45.0	±10%	45/450	50 x 98	27	R1008HP450P44N3	30	

450V Grip Wire Plastic Case M8 x 12 stud fixing

Value (uF)	Tolerance	Product Type	Dimensions	Fig	Order Code Dia x L. (mm)	Box	Quantity
5.0	±10%	5/450	30 x 74	28	R1008CR050P44	110	

Additional Capacitors on pae 49

fig 27



fig 28



fig 30

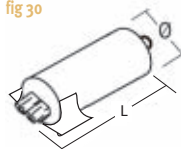
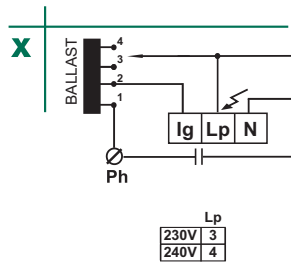
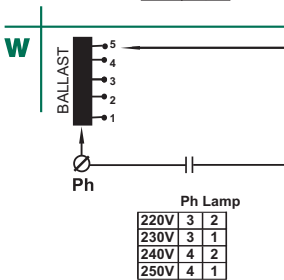
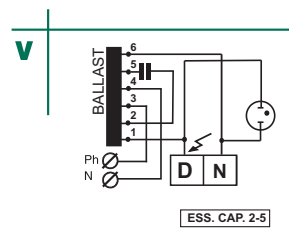
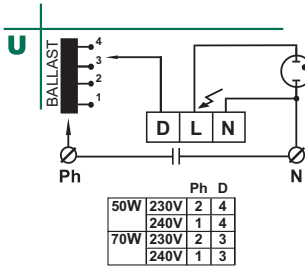
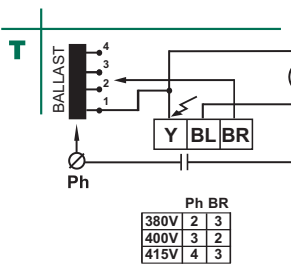
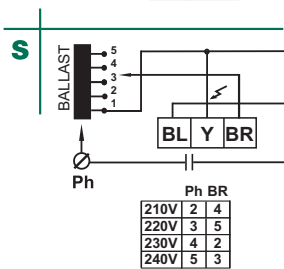
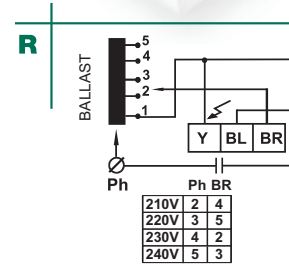
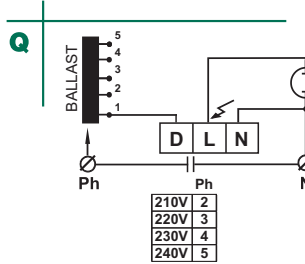
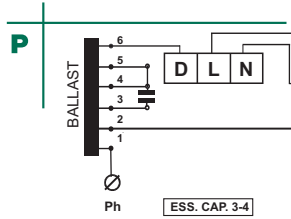
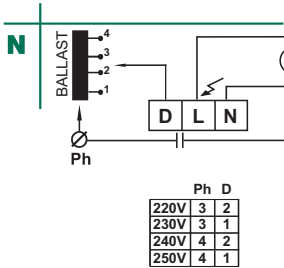
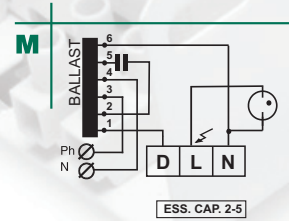
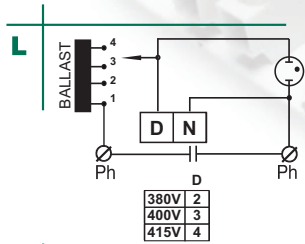
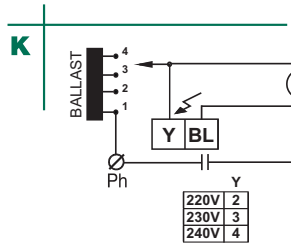
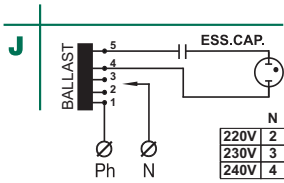
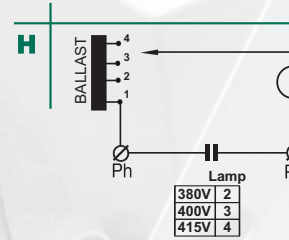
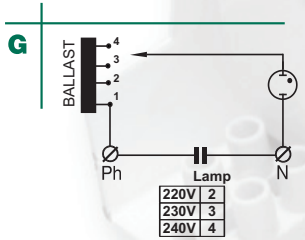
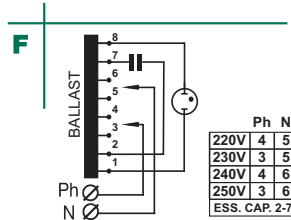
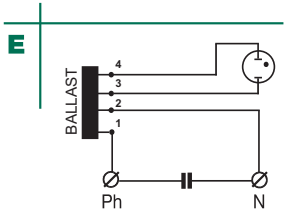
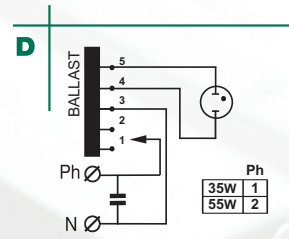
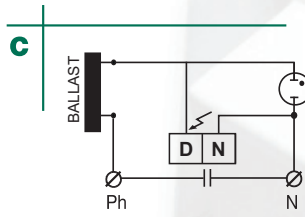
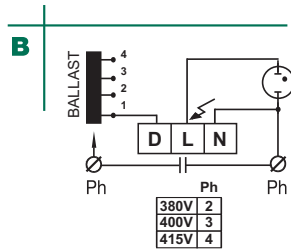
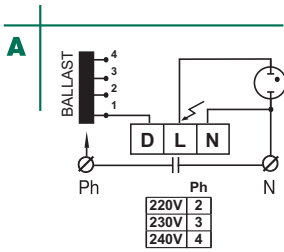

fig 37



Circuit Diagrams



Circuit Diagrams

Y

D
230V 3
240V 4

Z

Lamp
230V 3
240V 4

A1

Ph Y BR
220V 3 2 4
230V 3 1 4
240V 4 2 3
250V 4 1 3

B1

Y
230V 3
240V 4

C1

Ph BR
380V 2 3
400V 3 4
415V 4 5
430V 5 4

D1

Ph
380V 2
400V 3
415V 4
430V 5

E1

Ph
380V 2
400V 3
415V 4

F1

D
220V 2
240V 3

G1

Ph BR
220V 2 3
240V 3 2

H1

Lp
220V 3
230V 4

J1

D
220V 3
230V 4

K1

D
50Hz 230V 3
60Hz 210V 2

L1

Ph D
220V 3 2
230V 3 1
240V 4 2
254V 4 1

M1

Ph Y BR
220V 3 2 4
230V 3 1 4
240V 4 2 3
254V 4 1 3

N1

Ph
220V 2
230V 3
240V 4

ESS. CAP. 5-6

P1

lg Lp Ph
50W 230V 4 3 2
240V 4 3 1
70W 230V 3 4 2
240V 3 4 1

Q1

D
50W 3
70W 2

R1

Ph N
220V 3 4
230V 2 4
240V 3 5
250V 2 5

PFC. CAP. 2-5

S1

Lamp
35W 4
55W 3

T1

50Hz 60Hz Ph D
190V 210V 2 3
200V 220V 1 3
210V 230V 2 4
220V 240V 1 4
230V 250V 2 5
240V 260V 1 5

U1

50Hz 60Hz Ph Y BR
190V 210V 3 2 4
200V 220V 3 1 4
210V 230V 4 2 5
220V 240V 4 1 5
230V 250V 5 2 4
240V 260V 5 1 4

V1

50Hz 60Hz Ph D
200V 220V 2 3
210V 230V 1 3
220V 240V 2 4
230V 250V 1 4
240V 260V 2 5
250V 270V 1 5

W1

L brown
N blue
Dimming white
Earth green/yellow

X1

Ph Power N
230V 2 Full 4
240V 1 Dim 3

Circuit Diagrams

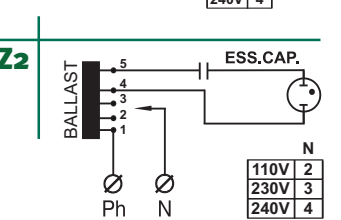
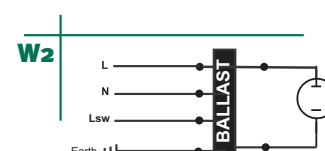
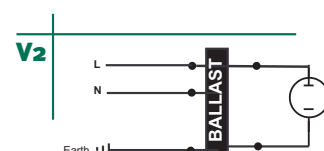
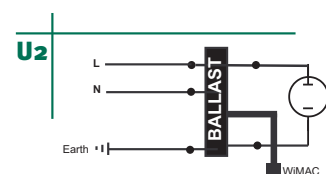
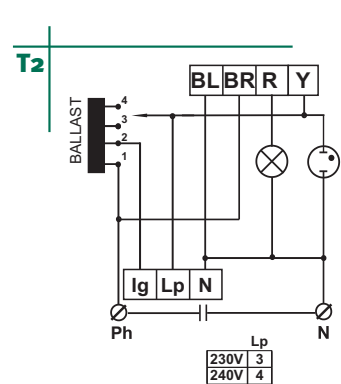
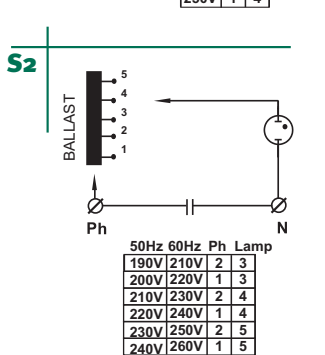
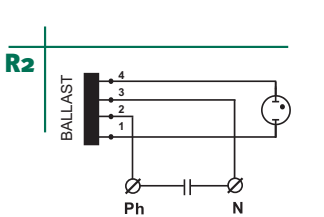
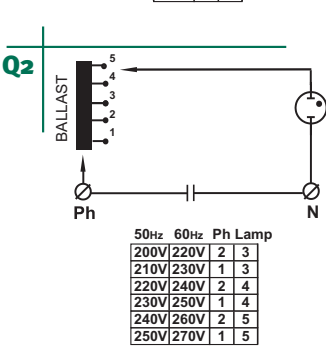
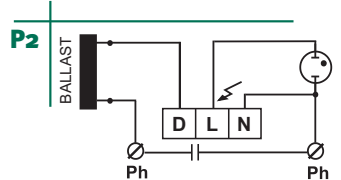
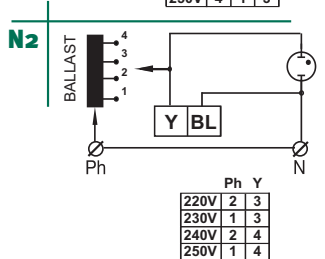
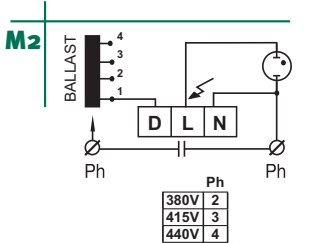
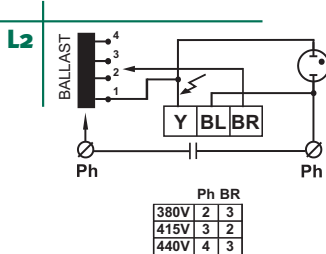
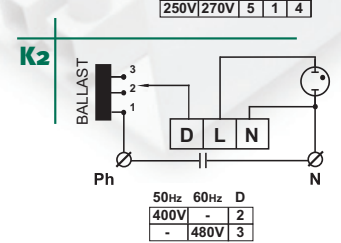
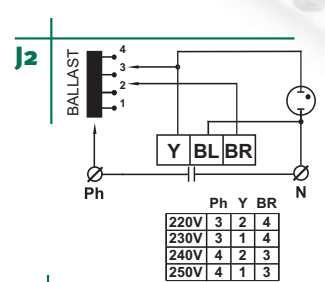
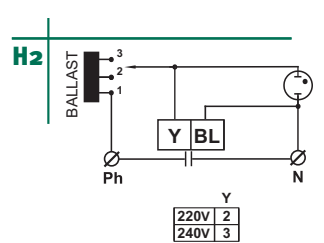
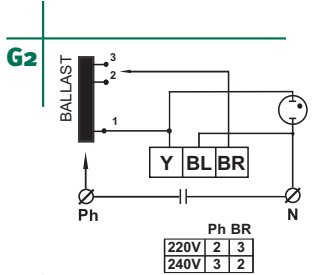
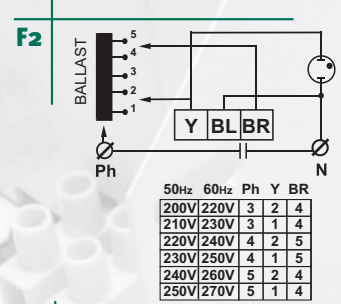
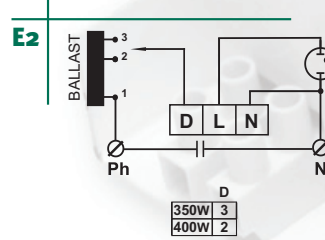
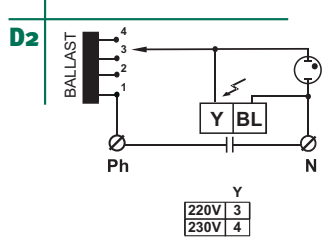
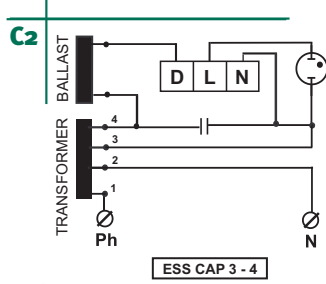
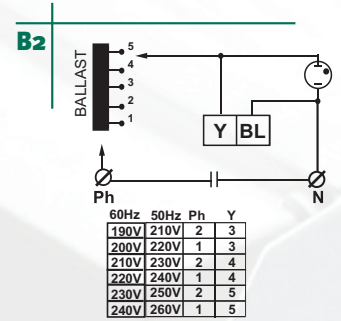
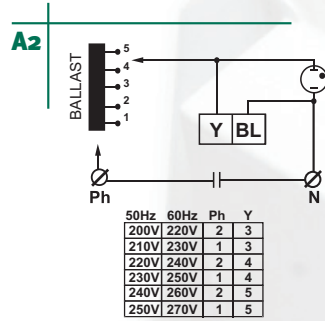
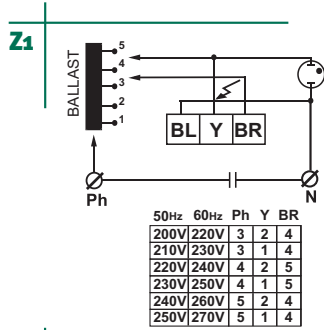
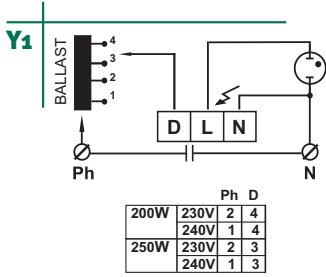

Glossary of Terms

Arc Tube: A completely sealed quartz or ceramic tube where the electrical discharge (arc) occurs and generates light

Auxiliary Light: Back-up light source to the HID light; typically a quartz halogen type

Ballast: A device that, by means of resistance, inductance, capacitance or electronic elements, singly or in combination, controls the current, voltage and waveform to the required values for proper lamp starting and operation for a HID ballast operating at a given supply voltage

Ballast Characteristic Curve: The curve of lamp wattage vs. lamp voltage over a range of normal lamp voltages, when a HID ballast operates at a given supply voltage

Ballast Factor: Typically associated with fluorescent systems; metal halide ballasts are designed to operate lamps at rated watts, whereas some fluorescent systems are designed to operate at a fraction of rated watts

Burning Position: The position in which lamps are designed to operate

Cold Start Time: The amount of time from the application of ballast voltage to ignition of the arc discharge

Colour Rendering Index (Ra): A measure of a light source's ability to render colours relative to a standard

Constant Wattage Autotransformer (CWA)

Control Gear: An autotransformer lead ballast circuit incorporating a capacitor in series with the lamp; compared to other ballasts, the CWA regulates over a wider input voltage range, holding lamp wattage to a narrow range by controlling lamp current

Correlated Colour Temperature (CCT): The perceived "colour" of the light emitted by a lamp expressed in Kelvin (K units)

Current Crest Factor: The ratio of the peak to the rms value of lamp current; metal halide values range from 1.5 to 1.8

Economic Life: The number of hours a group of lamps will burn before it is economically and aesthetically advisable to group relamp (typically 60% to 75% of rated life)

Efficacy (Lamp): A ratio of lumens to watts; often calculated with either lamp watts

or system watts; measured in lumens per watt (LPW)

Formed Body Arc Tube: Precisely reproducible ellipsoidal arc tube formed by Venture's quartz sculpting process; has 2/3 less quartz mass than standard arc tubes for equivalent lumens; has no starter electrode

HID: High Intensity Discharge lamps; includes metal halide, mercury vapor and high pressure sodium

Hot Restart or Restrike Time: The amount of time from return of power after an interruption to the point of lamp ignition

Ignitor: An electronic device which provides, by itself or in combination with other circuit components, the appropriate electrical conditions to start a discharge lamp

Ignitor CWA Control Gear: CWA control gear using an ignitor to start the lamp

Initial Lumens: The light output of a lamp, based on photometry results, at rated wattage after 100 hours of operation

Input Voltage at Lamp Dropout (Extinction Voltage): The rms value of supply voltage at which a reference lamp extinguishes when the supply voltage is uniformly reduced from rated value at 2% to 3% of rated voltage per second

Input Watts: The power measured on the input terminals of a ballast which is operating a reference lamp

Lag Ballast: A ballast exhibiting primarily inductive electrical characteristics, including a lagging lamp current with respect to line voltage and lagging or corrected line power factor.

Lamp Voltage: The voltage at which lamps operate when they are fully warmed up

Lamp Wattage: The power consumed by a lamp after warm-up

Light Center Length (LCL): The distance from the center of the arc discharge to the end contact of the base

Lumens: A measurement of light output; takes into account the human eye sensitivity curve so that more weight is given to the yellow-green part of the light spectrum

Lumen Maintenance: The lumen output provided by a lamp at a given point in or percentage of its life

Lumens Per Watt (LPW): A ratio of lumens to watts; often calculated with either lamp watts or system watts; measured in lumens per watt (LPW)

Luminaire Requirements: The type of luminaire a lamp requires; i.e., enclosed or open rated

Maximum Overall Length (MOL): The maximum allowable distance from the top of the glass bulb to the end contact of the base

Normal (Low) Power Factor Ballast: A ballast of the multiple-supply type that does not have a means for correcting the input power factor

Occupancy Sensor: Control device that dims or turns lights off after the space becomes unoccupied; may be ultrasonic or infrared-actuated

Open Circuit Current (Line): The RMS current measured through the input terminals of a ballast with lamp removed or inoperative

Open Circuit Voltage, Ballast (OCV): The voltage across the output terminals of a ballast when no load is connected (RMS, unless otherwise stated)

Open Rated Lamp (E27): Designed for open luminaires; has a narrower neck than standard E27 base lamps. Lamp arc tube is surrounded by a protective quartz shroud.

Open Rated Lamp (E40): Designed for open luminaires. Lamp arc tube is surrounded by a protective quartz shroud.

Operating Current (Line): The power factor corrected current measured through the input terminals of a ballast which is operating a reference lamp

Operating Voltage: The voltage at which lamps operate when they are fully warmed up

Peak Lead Ballast: A ballast that produces a highly peaked open circuit voltage wave shape and has a capacitor in series with the lamp

Position Oriented Mogul Base (POMB, EP39, EP40): Used with horizontal burning lamps; has an aligning pin embedded in the base for proper lamp orientation when it is screwed

Arc Tube: A completely sealed quartz or ceramic tube where the electrical discharge (arc) occurs and generates light

Auxiliary Light: Back-up light source to the HID light; typically a quartz halogen type

Ballast: A device that, by means of resistance, inductance, capacitance or electronic elements, singly or in combination, controls the current, voltage and waveform to the required values for proper lamp starting and operation for a HID ballast operating at a given supply voltage

Ballast Characteristic Curve: The curve of lamp wattage vs. lamp voltage over a range of normal lamp voltages, when a HID ballast operates at a given supply voltage

Ballast Factor: Typically associated with fluorescent systems; metal halide ballasts are designed to operate lamps at rated watts, whereas some fluorescent systems are designed to operate at a fraction of rated watts

Burning Position: The position in which lamps are designed to operate

Cold Start Time: The amount of time from the application of ballast voltage to ignition of the arc discharge

Colour Rendering Index (Ra): A measure of a light source's ability to render colours relative to a standard

Constant Wattage Autotransformer (CWA)

Control Gear: An autotransformer lead ballast circuit incorporating a capacitor in series with the lamp; compared to other ballasts, the CWA regulates over a wider input voltage range, holding lamp wattage to a narrow range by controlling lamp current

Correlated Colour Temperature (CCT):

The perceived "colour" of the light emitted by a lamp expressed in Kelvin (K units)

Current Crest Factor: The ratio of the peak to the rms value of lamp current; metal halide values range from 1.5 to 1.8

Economic Life: The number of hours a group of lamps will burn before it is economically and aesthetically advisable to group relamp (typically 60% to 75% of rated life)

Efficacy (Lamp): A ratio of lumens to watts; often calculated with either lamp watts

or system watts; measured in lumens per watt (LPW)

Formed Body Arc Tube: Precisely reproducible ellipsoidal arc tube formed by Venture's quartz sculpting process; has 2/3 less quartz mass than standard arc tubes for equivalent lumens; has no starter electrode

HID: High Intensity Discharge lamps; includes metal halide, mercury vapor and high pressure sodium

Hot Restart or Restrike Time: The amount of time from return of power after an interruption to the point of lamp ignition

Ignitor: An electronic device which provides, by itself or in combination with other circuit components, the appropriate electrical conditions to start a discharge lamp

Ignitor CWA Control Gear: CWA control gear using an ignitor to start the lamp

Initial Lumens: The light output of a lamp, based on photometry results, at rated wattage after 100 hours of operation

Input Voltage at Lamp Dropout (Extinction Voltage): The rms value of supply voltage at which a reference lamp extinguishes when the supply voltage is uniformly reduced from rated value at 2% to 3% of rated voltage per second

Input Watts: The power measured on the input terminals of a ballast which is operating a reference lamp

Lag Ballast: A ballast exhibiting primarily inductive electrical characteristics, including a lagging lamp current with respect to line voltage and lagging or corrected line power factor.

Lamp Voltage: The voltage at which lamps operate when they are fully warmed up

Lamp Wattage: The power consumed by a lamp after warm-up

Light Center Length (LCL): The distance from the center of the arc discharge to the end contact of the base

Lumens: A measurement of light output; takes into account the human eye sensitivity curve so that more weight is given to the yellow-green part of the light spectrum

Lumen Maintenance: The lumen output provided by a lamp at a given point in or percentage of its life

Lumens Per Watt (LPW): A ratio of lumens to watts; often calculated with either lamp watts or system watts; measured in lumens per watt (LPW)

Luminaire Requirements: The type of luminaire a lamp requires; i.e., enclosed or open rated

Maximum Overall Length (MOL): The maximum allowable distance from the top of the glass bulb to the end contact of the base

Normal (Low) Power Factor Ballast: A ballast of the multiple-supply type that does not have a means for correcting the input power factor

Occupancy Sensor: Control device that dims or turns lights off after the space becomes unoccupied; may be ultrasonic or infrared-actuated

Open Circuit Current (Line): The RMS current measured through the input terminals of a ballast with lamp removed or inoperative

Open Circuit Voltage, Ballast (OCV): The voltage across the output terminals of a ballast when no load is connected (RMS, unless otherwise stated)

Open Rated Lamp (E27): Designed for open luminaires; has a narrower neck than standard E27 base lamps. Lamp arc tube is surrounded by a protective quartz shroud.

Open Rated Lamp (E40): Designed for open luminaires. Lamp arc tube is surrounded by a protective quartz shroud.

Operating Current (Line): The power factor corrected current measured through the input terminals of a ballast which is operating a reference lamp

Operating Voltage: The voltage at which lamps operate when they are fully warmed up

Peak Lead Ballast: A ballast that produces a highly peaked open circuit voltage wave shape and has a capacitor in series with the lamp

Position Oriented Mogul Base (POMB, EP39, EP40): Used with horizontal burning lamps; has an aligning pin embedded in the base for proper lamp orientation when it is screwed into its socket; should only be used in yellow

Europe Headquarters:

Venture Lighting Europe Ltd.
Trinity Court
Batchworth Island
Church Street, Rickmansworth,
WD3 1RT, United Kingdom
+(44) 0845-2302222
Fax: +(44) 0845-2302077
sales@venturelighting.co.uk

Technical & Distribution Centre:

Venture Lighting Europe Ltd.
Unit 11,
Willow Farm Business Park,
Castle Donington,
DE74 2US,
United Kingdom
+(44) 01332 856060
Fax: +(44) 01332 856061

www.venturelightingeurope.com

North America and World Headquarters:

Venture Lighting International
32000 Aurora Road
Solon, Ohio 44139 USA
800-451-2606
440-248-3510
Fax: 800-451-2605
venture@adlt.com
www.venturelighting.com

Canada:

Venture Lighting
6889 Rexwood Road
Unit 6 & 7
Mississauga, Ontario L4V 1R2
Canada
905-678-6291
Fax: 905-678-2879
venturecanadasales@adlt.com

Latin America:

Venture Lighting International
5805 Blue Lagoon Drive
Suite 395
Miami, Florida 33126
USA
305-269-8114
Fax: 305-269-8727
vllatinamerica@adlt.com

Australia:

Venture Lighting
Australia
110 Lewis Road
Wantirna South
Victoria 3152
Australia
+(61) 3 9800 5600
Fax: +(61) 3 9800 5533
sales@advancedlighting.com.au

Singapore:

Advanced Lighting Technologies
Asia Pte Ltd.
Block 4008, Ang Mo Kio Avenue 10
#04-06, Techplace I.
Singapore 569625
(65) 6844-2338
Fax: (65) 6844-2339
vlseasia@adlt.com

Middle-East:

Venture Lighting
International FZE
P.O. Box 16994
Jebel Ali,
Dubai, U.A.E.
(971-4) 883-7370
Fax: (971-4) 883-7371
ventufze@emirates.net.ae

New Zealand:

Advanced Lighting
Technologies NZ LTD
8 Boeing Place,
Mt Maunganui
P.O.Box 11, Tauranga
New Zealand
+(64) 09-07 579 0163
Fax: +(64) 09-07 579 0164
light@adlt.co.nz

Japan:

Venture Lighting
Japan, Inc.
Bunmeido Bldg. 6F
16-5, Taito 3-Chome
Taito-Ku, Tokyo 110
(81) 03-3839-5711
Fax: (81) 03-3839-3724
vljapan@adlt.com

South Africa:

Venture Lighting
South Africa (PTY.) LTD.
Unit 44, Boulevard Way
Capricorn Business Park
Marina Da Gama, South Africa
+(27) 21-709-0180
Fax: +(27) 21-709-0198
vli-sa@iafrica.com

India:

Venture Lighting India
Plot No. A30
D5 Phase II Zone B, MEPZ
Tambaram, Chennai, India 600045
+(91) 44-2383094
+(91) 44-2385567
Fax: +(91) 44-2385569
Email: mail@vlindia.com

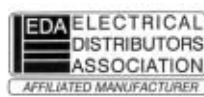

European HID Lighting Systems Catalogue | || || || ||

E & OE As our policy is one of continuous development, we reserve the right to amend designs and specifications without prior notice. Every care has been taken to ensure that the contents of this document are correct at the time of publication and we shall be under no liability whatsoever in respect of such contents.

LMPCAT.03.10.P05341.10M