

Features

- Formerly J. W. Miller® model
- Six windings - multiple configurations
- Compact size
- Tape and reel packaging
- RoHS compliant*

Applications

- Inductors: Buck-boost, coupled, filtering, common mode
- Transformers: Flyback, push-pull, inverter, gate drive, isolation

PM600/PM610/PM620 Series - SMD Inductor/Transformer

Electrical Specifications

Bourns Part No.	Inductance 100 KHz		DCR (Ω) Max.	Isat (A)	Irms (A)	<1> ET (VmS) Based on 40 °C Rise (260 KHz)	<1> ET (VmS) Based on Core Saturation
	(μH)	Tol. (%)					
PM600-01-RC	201.6	±30	0.324	0.02	0.46	16.8	103.2
PM600-02-RC	89.6	±30	0.137	0.03	0.71	11.2	68.8
PM600-03-RC	27.4	±10	0.324	0.31	0.46	16.8	103.2
PM600-04-RC	12.2	±10	0.137	0.47	0.71	11.2	68.8
PM600-05-RC	14.7	±10	0.324	0.58	0.46	16.8	103.2
PM600-06-RC	6.5	±10	0.137	0.87	0.71	11.2	68.8
PM600-07-RC	10.9	±10	0.324	0.88	0.46	16.8	103.2
PM600-08-RC	4.9	±10	0.137	1.32	0.71	11.2	68.8
PM600-09-RC	8.5	±10	0.324	1.23	0.46	16.8	103.2
PM600-10-RC	3.8	±10	0.137	1.85	0.71	11.2	68.8
PM610-01-RC	160.0	±30	0.202	0.04	0.68	21.0	130
PM610-02-RC	78.4	±30	0.094	0.06	1.00	14.7	91
PM610-03-RC	21.6	±10	0.202	0.67	0.68	21.0	130
PM610-04-RC	10.6	±10	0.094	0.96	1.00	14.7	91
PM610-05-RC	11.6	±10	0.202	1.30	0.68	21.0	130
PM610-06-RC	5.7	±10	0.094	1.86	1.00	14.7	91
PM610-07-RC	8.3	±10	0.202	2.00	0.68	21.0	130
PM610-08-RC	4.1	±10	0.094	2.86	1.00	14.7	91
PM610-09-RC	6.6	±10	0.202	2.30	0.68	21.0	130
PM610-10-RC	3.2	±10	0.094	3.29	1.00	14.7	91
PM620-01-RC	160.6	±30	0.094	0.03	1.28	20.8	130
PM620-02-RC	77.0	±30	0.065	0.04	1.54	14.4	90
PM620-03-RC	131.8	±20	0.094	0.08	1.28	20.8	130
PM620-04-RC	63.2	±20	0.065	0.12	1.54	14.4	90
PM620-05-RC	23.3	±10	0.094	0.36	1.28	20.8	130
PM620-06-RC	11.2	±10	0.065	0.52	1.54	14.4	90
PM620-07-RC	14.2	±10	0.094	0.76	1.28	20.8	130
PM620-08-RC	6.8	±10	0.065	1.10	1.54	14.4	90
PM620-09-RC	9.3	±10	0.094	1.11	1.28	20.8	130
PM620-10-RC	4.5	±10	0.065	1.60	1.54	14.4	90
PM620-11-RC	7.9	±10	0.094	1.40	1.28	20.8	130
PM620-12-RC	3.8	±10	0.065	2.02	1.54	14.4	90

<1> Single or multi-windings in parallel. ET of multiple winding in series is number of windings times value of ET.

General Specifications

Rated Current..... Ind. drop of 30 % typ.
at Isat
 Temperature Rise ... 40 °C typical at Irms
 Operating Temperature
-40 °C to +105 °C
 Storage Temperature
-40 °C to +105 °C
 Soldering 245 °C, 5 seconds max.
 Dielectric Strength 500 Vrms
 between windings

Materials

Core..... Ferrite
 Wire Polyurethane-coated copper
 Terminal Coating..... Sn-Ag-Cu alloy
 Packaging
 PM600.....600 pcs. per 13-inch reel
 PM610.....300 pcs. per 13-inch reel
 PM620.....200 pcs. per 13-inch reel

*RoHS Directive 2002/95/EC Jan. 27, 2003 including annex and RoHS Recast 2011/65/EU June 8, 2011. Specifications are subject to change without notice. Customers should verify actual device performance in their specific applications.

Typical Configurations

Inductor:



Basic Diagram
Inductance: L
Current: I



Figure 1
Inductance: 36 x L
Current: I



Figure 2
Inductance: 25 x L
Current: I



Figure 3
Inductance: 16 x L
Current: I



Figure 4
Inductance: 9 x L
Current: 2 x I

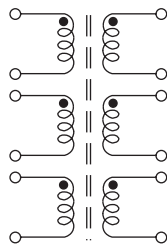

Figure 5
Inductance: 4 x L
Current: 3 x I



Figure 6
Inductance: L
Current: 6 x I

Transformer:



Basic Diagram
Turns Ratio:
1:1:1:1:1

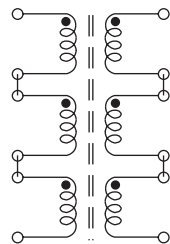

Figure 1
Turns Ratio:
1:1



Figure 2
Turns Ratio:
1:1:1



Figure 3
Turns Ratio:
1:5 or 5:1



Figure 4
Turns Ratio:
1:4 or 4:1

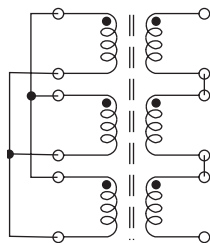

Figure 5
Turns Ratio:
1:3 or 3:1

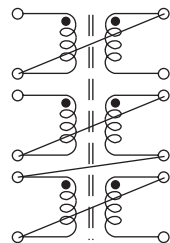

Figure 6
Turns Ratio:
1:2 or 2:1



Figure 7
Turns Ratio:
4:1:1



Figure 8
Turns Ratio:
3:1:1:1



Figure 9
Turns Ratio:
2:3 or 3:2

PM600/PM610/PM620 Series - SMD Inductor/Transformer

BOURNS®

Product Dimensions

PM600 Series

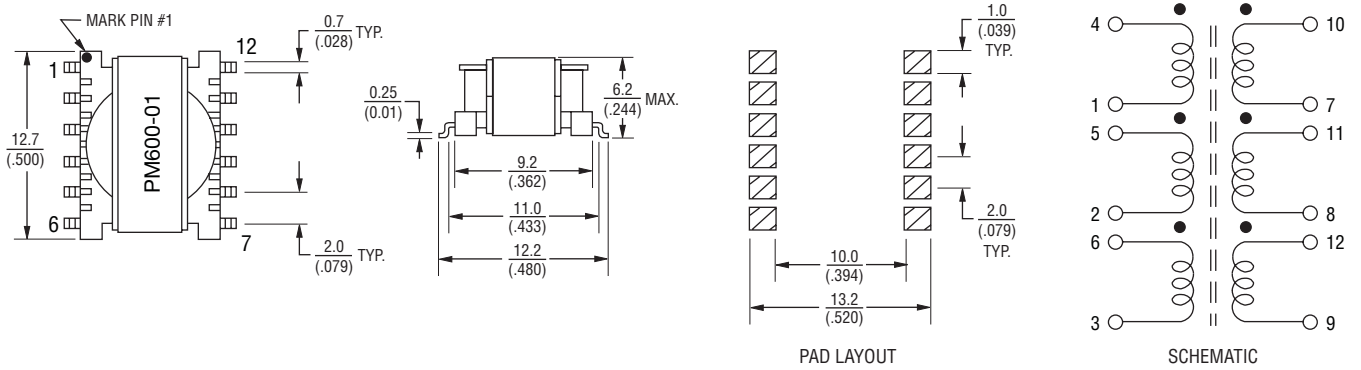

PM610 Series

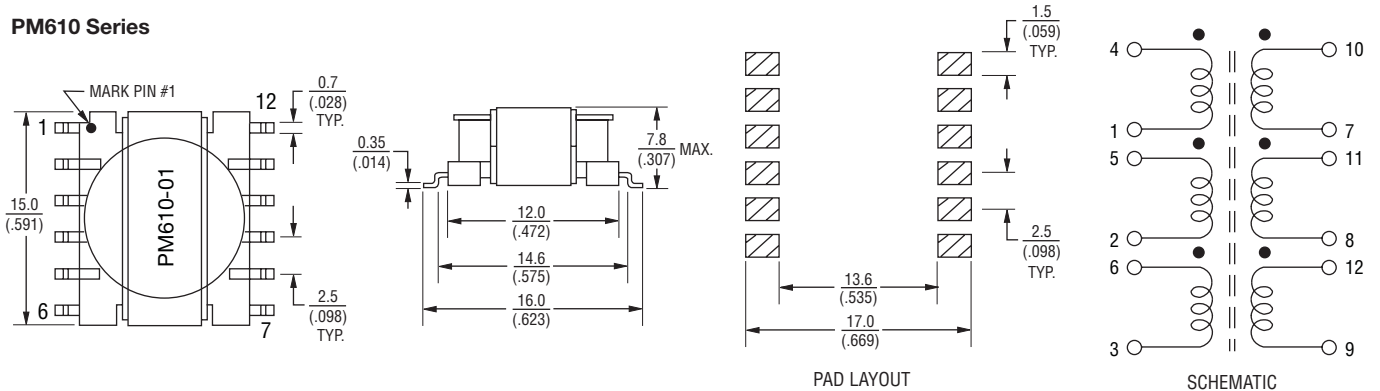

PM620 Series

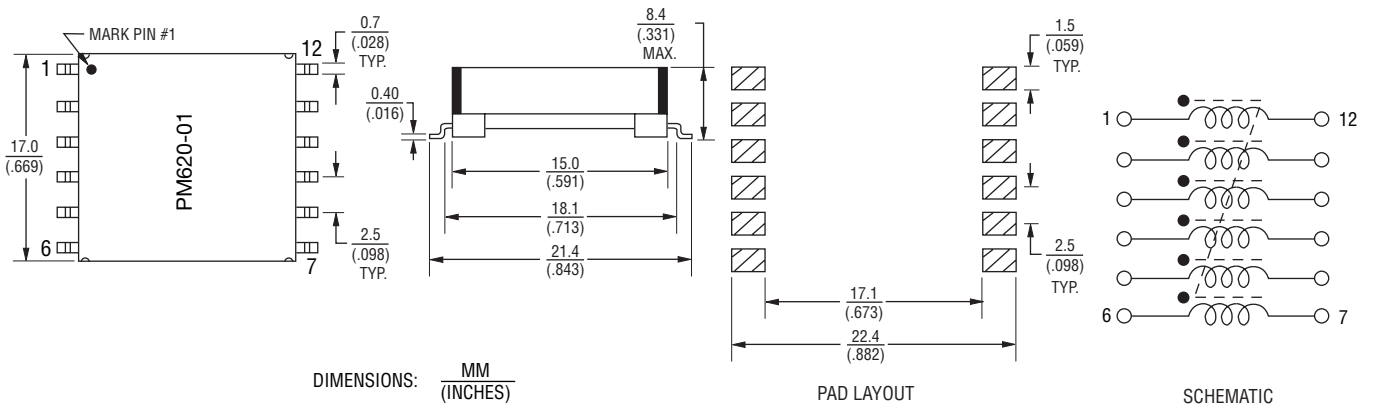

Specifications are subject to change without notice.
Customers should verify actual device performance in their specific applications.

PM600/PM610/PM620 Series - SMD Inductor/Transformer

BOURNS®

Packaging Specifications

PM600



PM610

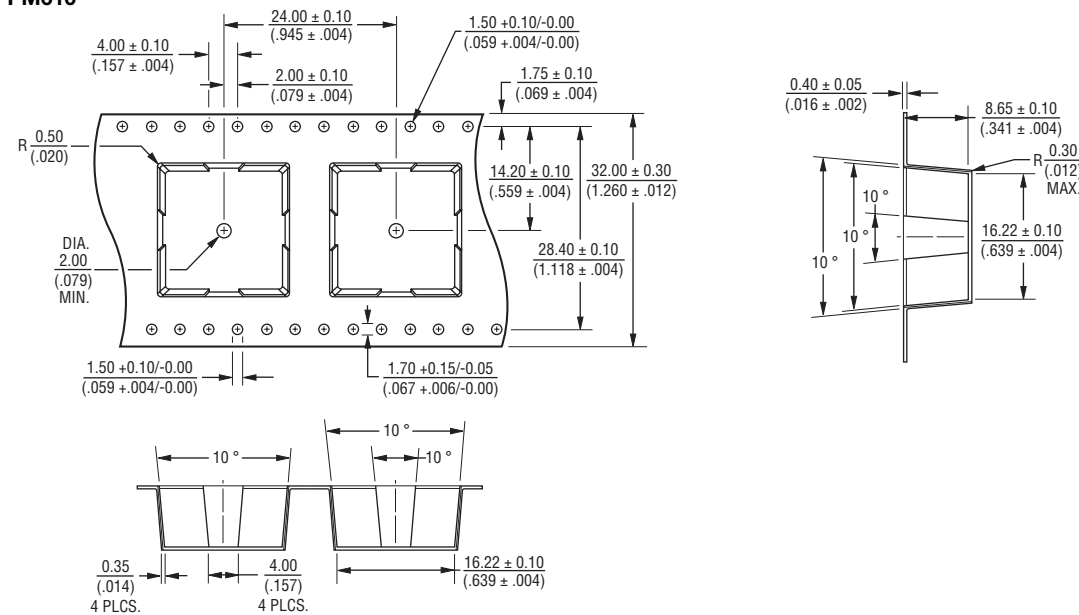

DIMENSIONS: $\frac{\text{MM}}{\text{(INCHES)}}$

PM600/PM610/PM620 Series - SMD Inductor/Transformer

BOURNS®

Packaging Specifications (Continued)

PM620



DIMENSIONS: $\frac{\text{MM}}{\text{(INCHES)}}$

<1> Single or multi-windings in parallel. ET of multiple winding in series is number of windings times value of ET.

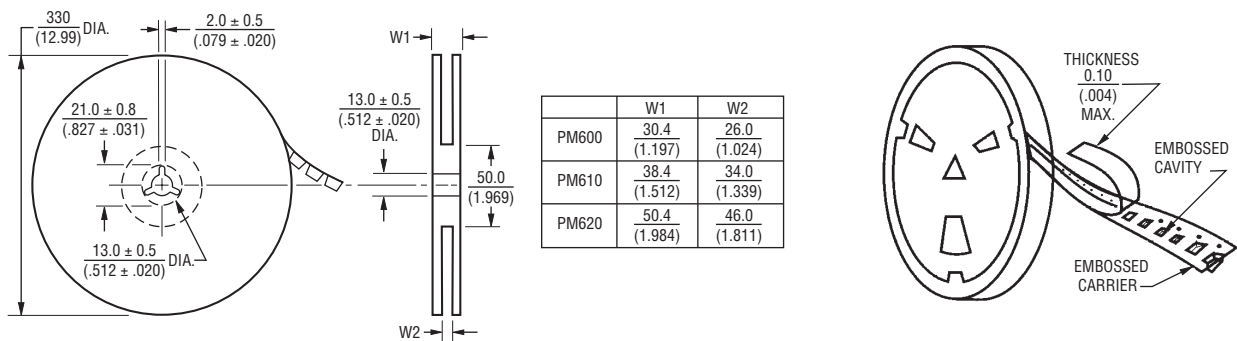

REV. 06/08

Specifications are subject to change without notice.
Customers should verify actual device performance in their specific applications.