

SPECIFICATION

Part No. : **GW26.0152**

Product Name : 2.4GHz Miniature Screw mount Monopole
Antenna

Feature : RP-SMA(M)
Fixed 90°
ROHS Compliant



1 Introduction

The GW.26 2.4 GHz Monopole RP-SMA(M) antenna is ideal for 2.4 GHz wireless applications such as Bluetooth and Wireless LAN. Connector mount is fully customizable.

2 Specification

| Wi-Fi 2.4GHz | |
|-----------------------|-----------------------|
| Frequency | 2400~2500MHz |
| Bandwidth | 1000MHz |
| Peak Gain | > 0dBi |
| Radiation Efficiency | > 40% |
| Radiation | Omni-directional |
| Polarization | Vertical |
| Power Handling 1W Max | Power Handling 1W Max |
| Electrical Wave | Monopole |
| Impedance | 50Ω |
| Operating Temperature | -40°C ~ +85°C |
| Storage Temperature | -40°C ~ +85°C |

3 Mechanical Properties

| Mechanical Properties | |
|-----------------------|-----------------|
| Colour | Black and Green |
| Connector | RP-SMA(M) R/A |
| IP rating | IP-65 |

4 Antenna Characteristics

4.1 Antenna S11

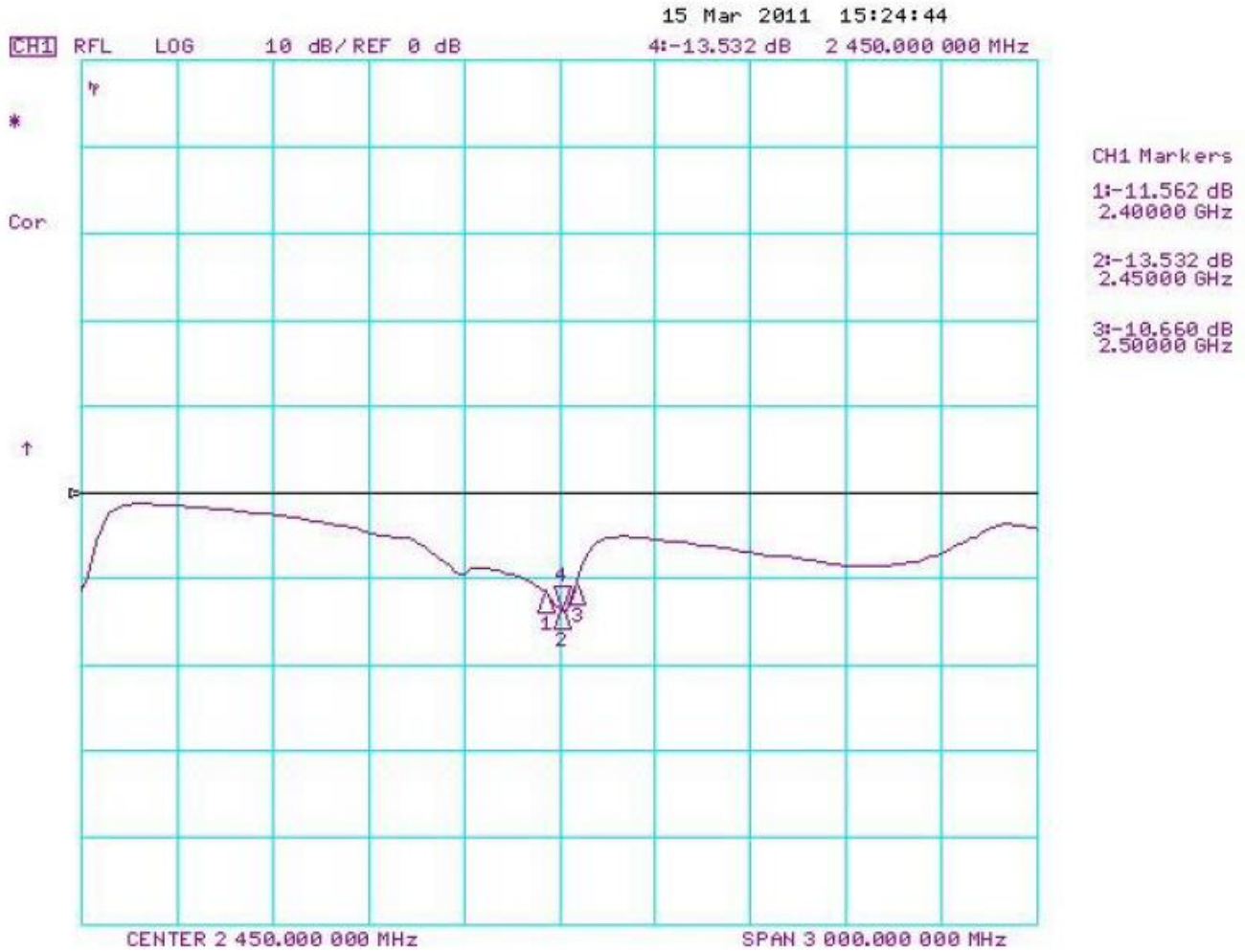

4.2 Antenna Peak Gain

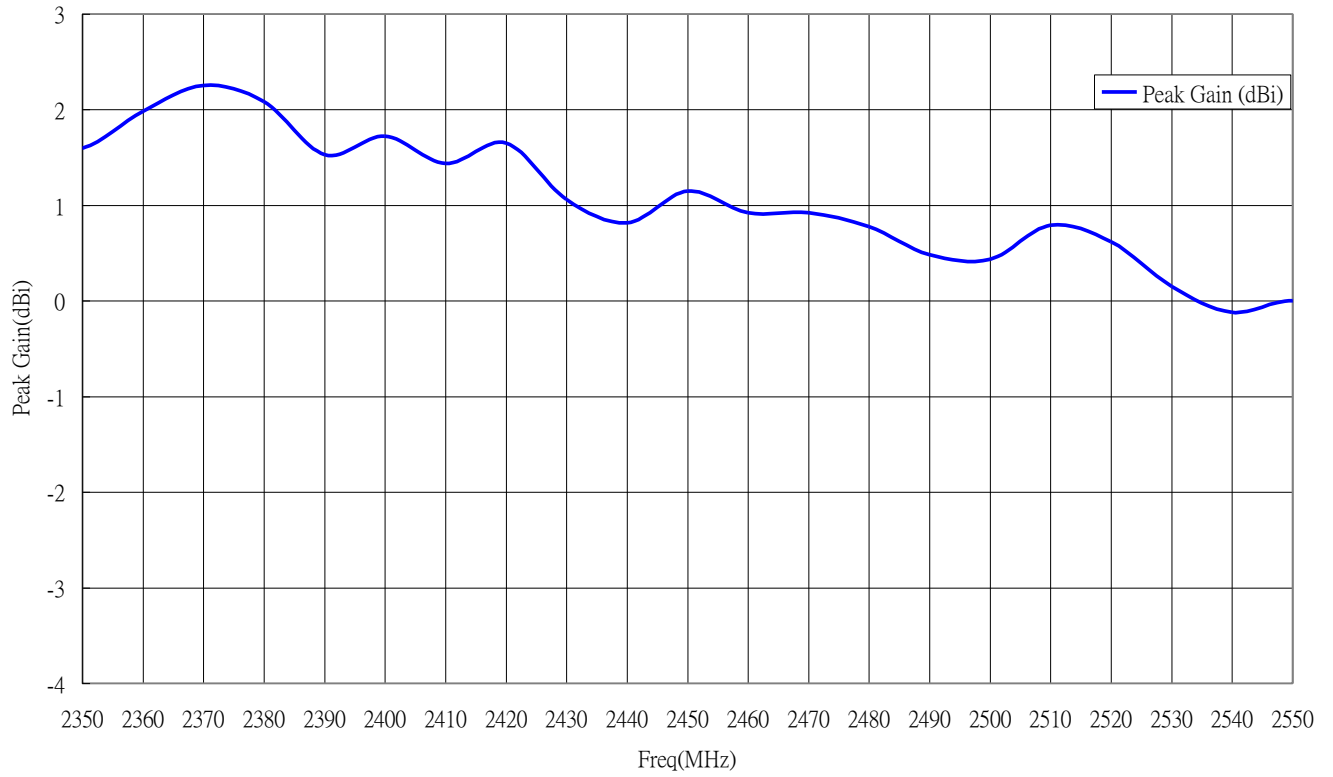

4.3 Antenna Efficiency

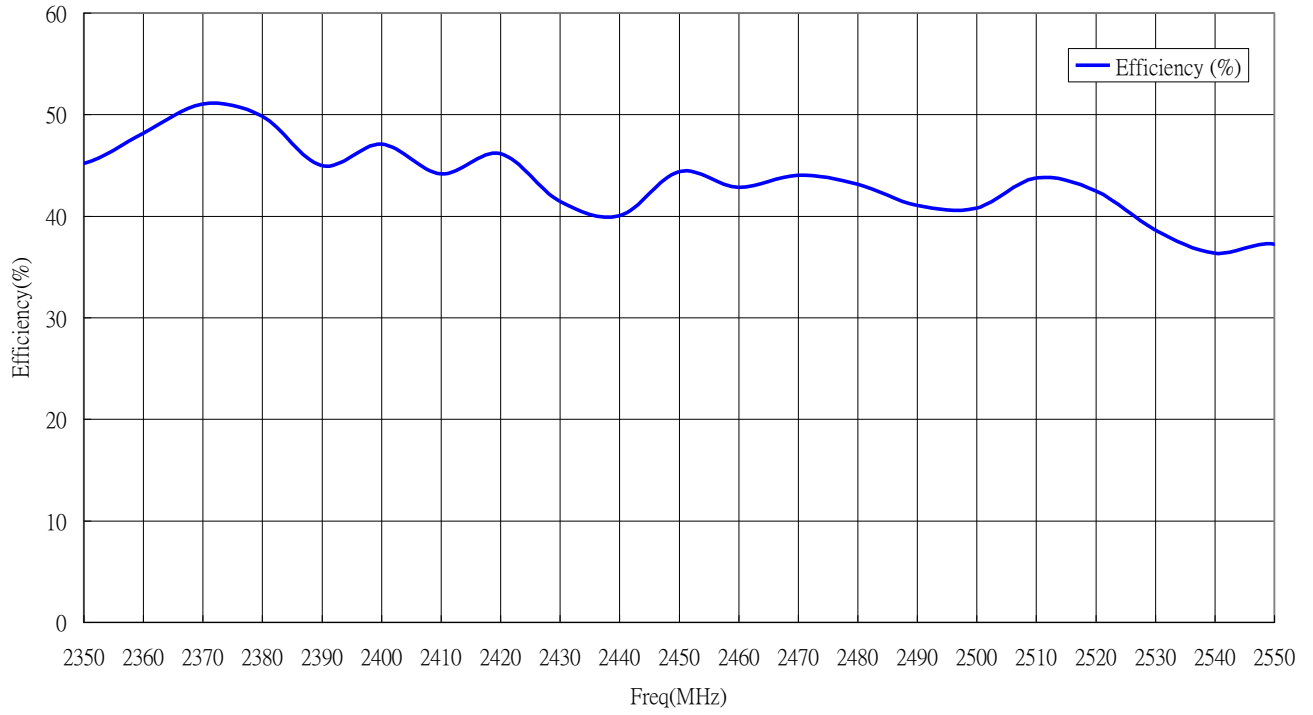

4.4 Antenna pattern (XY plane)

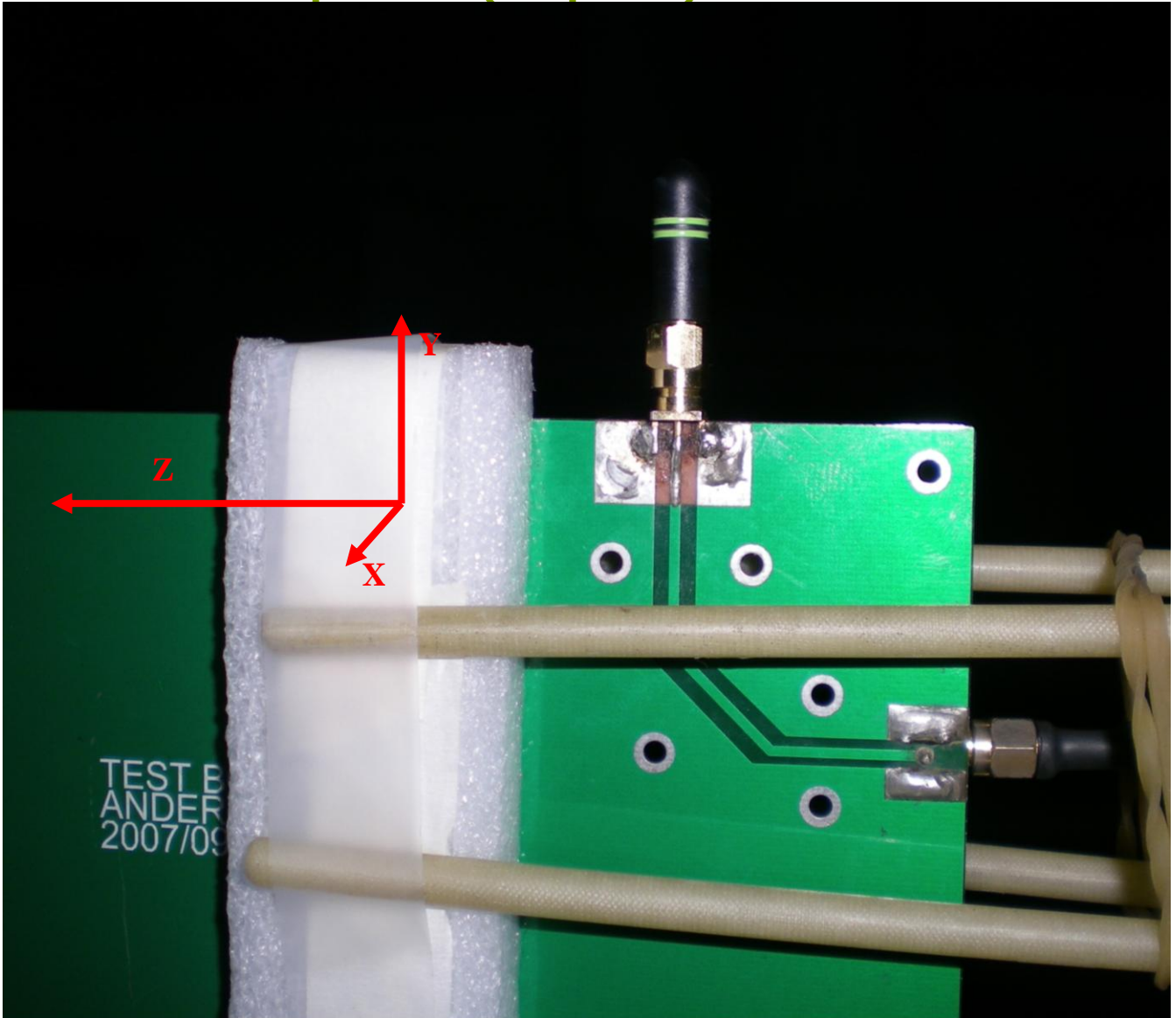

4.5 Antenna pattern (XY plane)

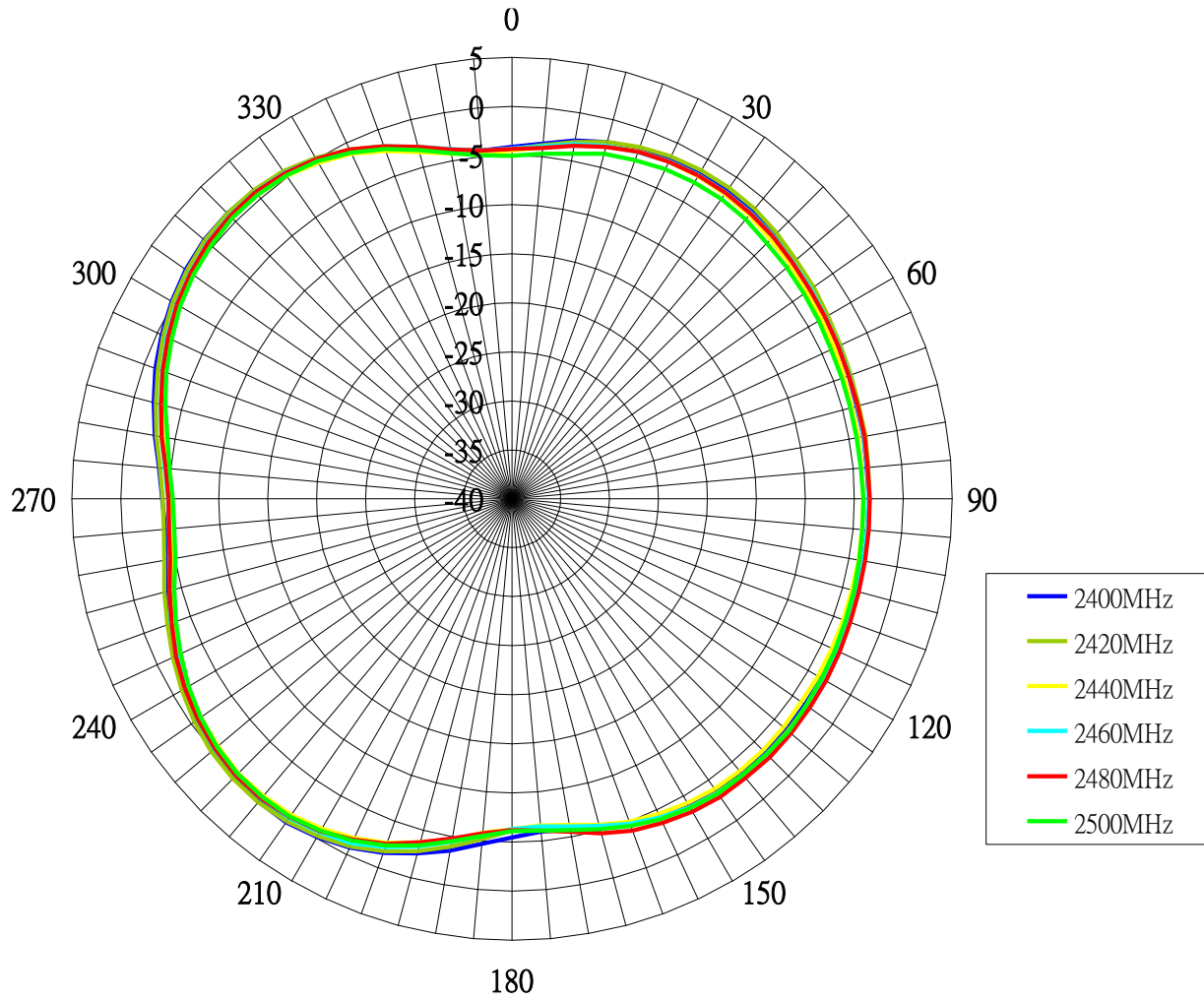

4.6 Antenna pattern (XZ plane)

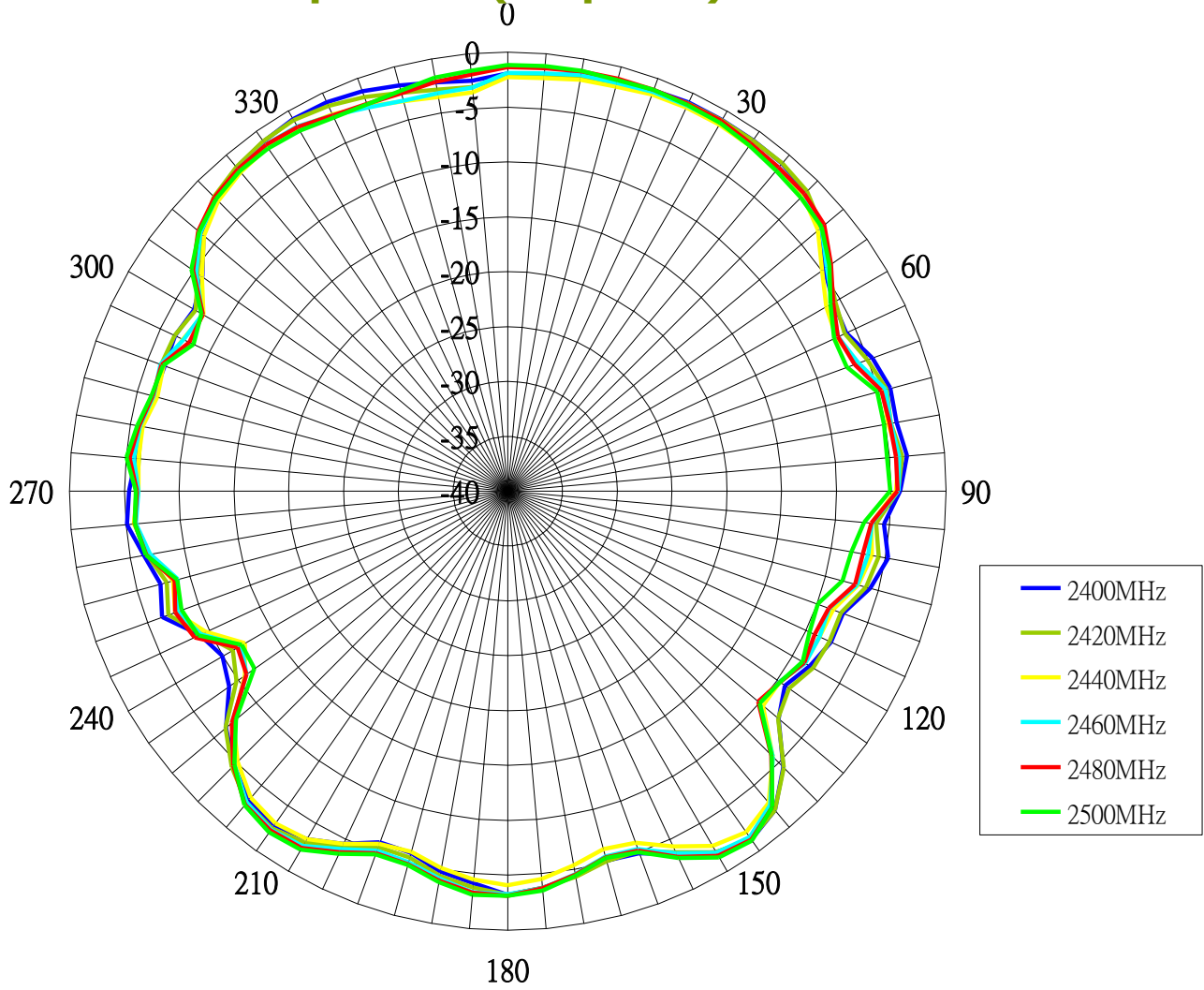

4.7 Antenna pattern (YZ plane)

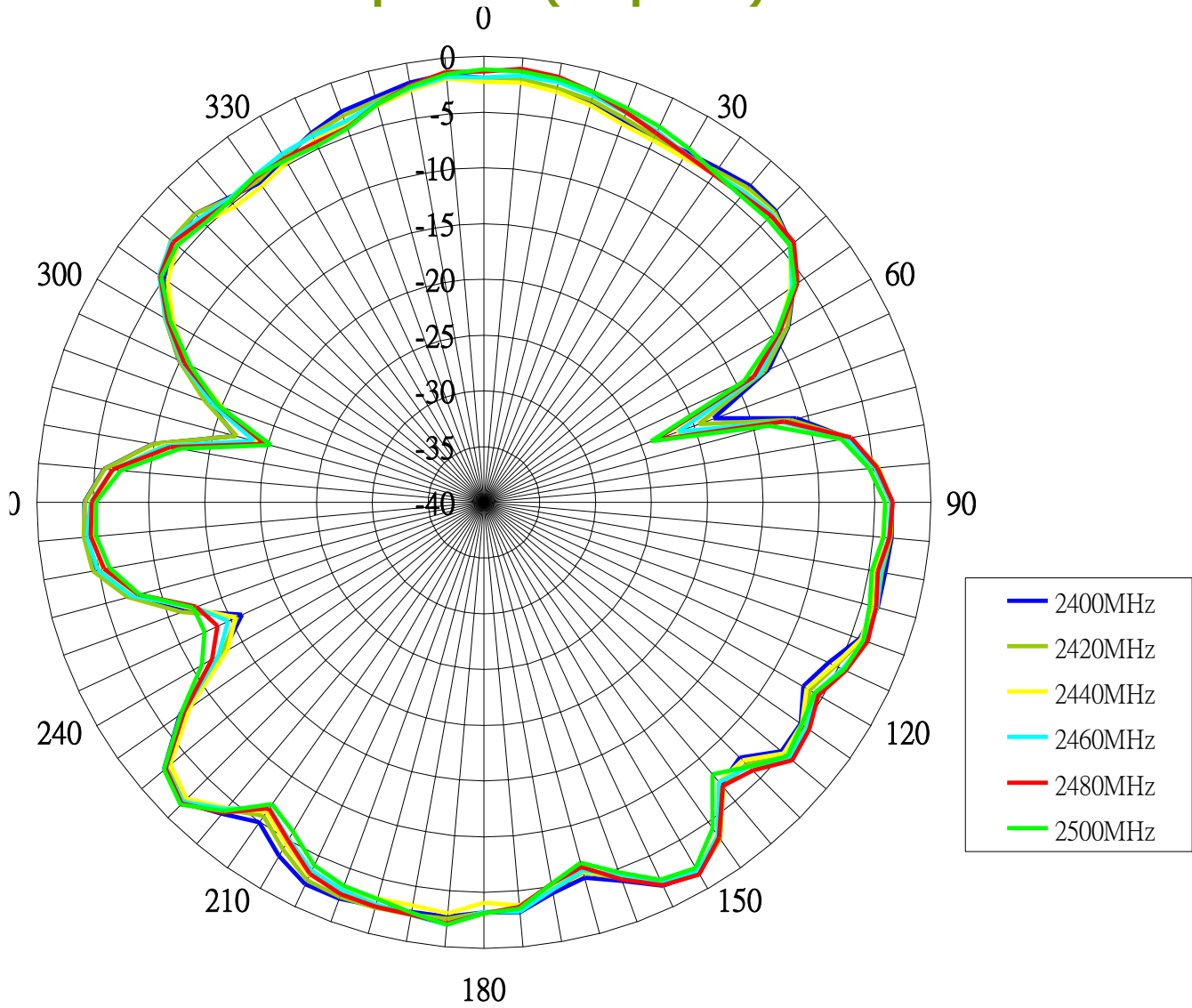

5. Outline Drawings and Structure

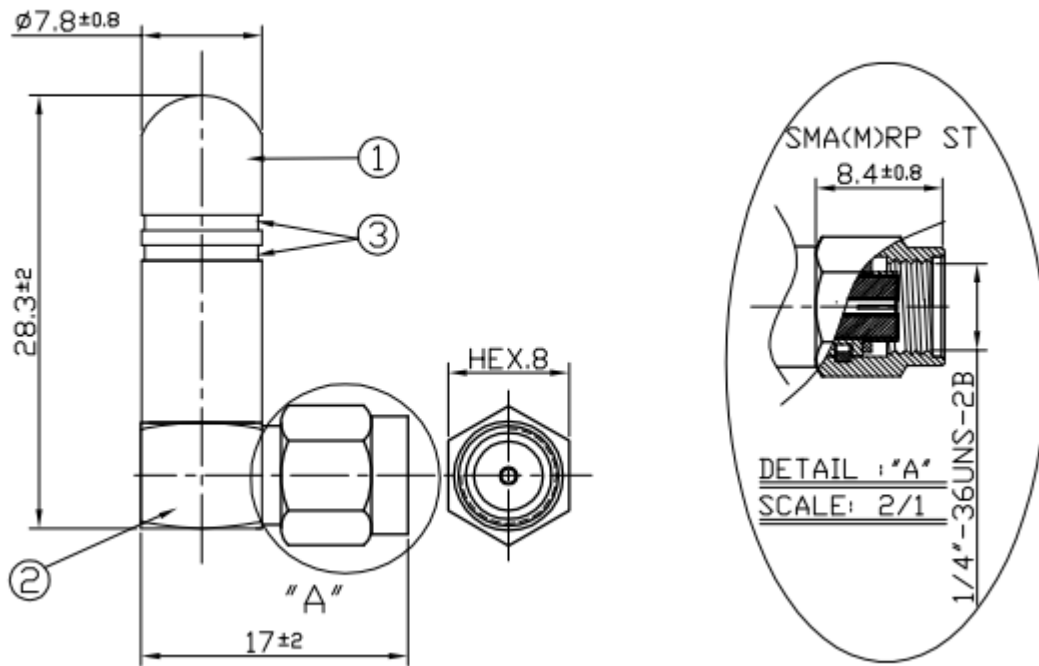

Key

| | | |
|---|----------------|-------------|
| 1 | Antenna Cover | TPU(Black) |
| 2 | Connector | RP-SMA(M) |
| 3 | Colour Stripes | Apple Green |