

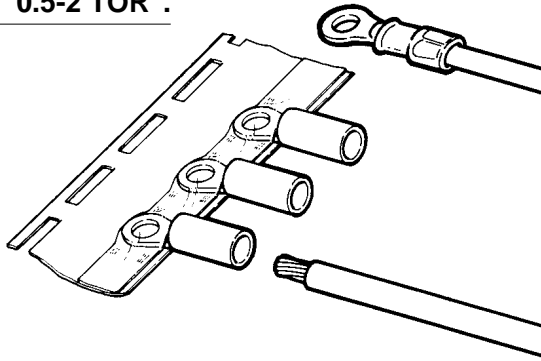

RING TONGUE TERMINAL

Terminals mounted on transparent tape can be crimped efficiently by a specially-designed automatic crimping machine. In addition, high uniform crimping is ensured since the terminals are crimped at a fixed position. To identify tape-mounted terminals, "TOR" is affixed to the parts numbers of non-taped terminals.

Ordering example: "0.5-2 TOR".



Order No.	Q'ty/reel	Die set No.
0.5-2 TOR	1,000	3H-2622
0.5-3 TOR		
0.5-3.7 TOR		
0.5-4 TOR		
V0.5-3 TOR	1,000	3V-2622N
V0.5-3.7 TOR		
V0.5-4 TOR		
V0.5-5 TOR		
FV0.5-3 TOR	1,000	3V-2622N
FV0.5-3.7 TOR		
FV0.5-4 TOR		
FV0.5-5 TOR		
N0.5-3 TOR	1,000	3V-2622N
FVD0.5-3 TOR	1,000	3V-2622N
FVD0.5-4 TOR	1,000	3H-2216
1.25-3 TOR		
1.25-3.7 TOR		
1.25-MS3 TOR		
1.25-M3 TOR		
1.25-L3 TOR		
1.25-M4 TOR		
1.25-4 TOR		
1.25-5 TOR		
1.25-6 TOR		
1.25-8 TOR		
1.25-10 TOR		
V1.25-3 TOR	1,000	3V-2216N
V1.25-3.7 TOR		
V1.25-MS3 TOR		
V1.25-L3 TOR		
V1.25-M4 TOR		
V1.25-4 TOR		
V1.25-5 TOR		
V1.25-6 TOR		

Note:1) Delivery lead times may vary depending on the product. Contact JST for details.

Order No.	Q'ty/reel	Die set No.
FV1.25-3 TOR	1,000	3V-2216N
FV1.25-3.7 TOR		
FV1.25-MS3 TOR		
FV1.25-M3 TOR		
FV1.25-L3 TOR		
FV1.25-M4 TOR		
FV1.25-4 TOR		
FV1.25-5 TOR		
FV1.25-6 TOR		
FV1.25-8 TOR		
FV1.25-10 TOR	1,000	3V-2216N
FVX1.25-5 TOR		
FVX1.25-10 TOR		
FVL1.25-3 TOR		
FVL1.25-3.7 TOR	1,000	3V-2216N
FVL1.25-MS3 TOR		
FVL1.25-M3 TOR		
FVL1.25-M4 TOR		
FVL1.25-4 TOR		
FVL1.25-5 TOR		
N1.25-3.7 TOR	1,000	3V-2216N
N1.25-MS3 TOR		
N1.25-M3 TOR		
N1.25-M4 TOR		
FN1.25-3 TOR	1,000	3V-2216N
FN1.25-4 TOR	1,000	3V-2216N
VD1.25-4 TOR	1,000	3V-2216D
VD1.25-5 TOR		
VD1.25-6 TOR		
VD1.25-10 TOR		
FVD1.25-3 TOR	1,000	3V-2216D
FVD1.25-3.7 TOR		
FVD1.25-MS3 TOR		
FVD1.25-M3 TOR		
FVD1.25-M4 TOR		
FVD1.25-4 TOR		
FVD1.25-5 TOR		
FVD1.25-6 TOR		

Note:1) Delivery lead times may vary depending on the product. Contact JST for details.



Order No.	Q'ty/reel	Die set No.
FND1.25-2 TOR	1,000	3V-2216D
FND1.25-M3 TOR		
FND1.25-5 TOR		
FND1.25-6 TOR		
FND1.25-8 TOR		
FND1.25-10 TOR		
2-S3.3 TOR	1,000	3H-1614
2-S3 TOR		
2-MS3 TOR		
2-M3 TOR		
2-3 TOR		
2-M4 TOR		
2-4 TOR		
2-M5 TOR		
2-5 TOR		
2-6 TOR		
2-8 TOR		
2-9 TOR		
V2-S3 TOR	1,000	3V-1614N
V2-MS3 TOR		
V2-M3 TOR		
V2-3 TOR		
V2-M4 TOR		
V2-P4 TOR		
V2-4 TOR		
V2-M5 TOR		
V2-5 TOR		
V2-6 TOR		
V2-8 TOR		
FV2-S3.3 TOR	1,000	3V-1614N
FV2-S3 TOR		
FV2-MS3 TOR		
FV2-M3 TOR		
FV2-3 TOR		
FV2-M4 TOR		
FV2-P4 TOR		
FV2-4 TOR		
FV2-M5 TOR		
FV2-5 TOR		
FV2-6 TOR		
FV2-8 TOR		
FVX2-P3.5 TOR	1,000	3V-1614N
FVL2-S3.3 TOR	1,000	3V-1614N
FVL2-MS3 TOR		
FVL2-M3 TOR		
FVL2-P3.5 TOR		
FVL2-3 TOR		
FVL2-M4 TOR		
FVL2-4 TOR		
FVL2-M5 TOR		
FVL2-5 TOR		
FVL2-6 TOR		
N2-M4 TOR	1,000	3V-1614N

Note:1) Delivery lead times may vary depending on the product.
Contact JST for details.

Order No.	Q'ty/reel	Die set No.
FVD2-S3 TOR	1,000	3V-1614D
FVD2-M3 TOR		
FVD2-M4 TOR		
FVD2-4 TOR		
FVD2-M5 TOR		
FVD2-5 TOR		
FVD2-6 TOR		
FVD2-8 TOR		
FND2-S3 TOR		
FND2-M3 TOR		
FND2-8 TOR	1,000	3V-1614D
5.5-S3 TOR		
5.5-3 TOR		
5.5-S4 TOR	1,000	3H-1210N
5.5-4 TOR		
5.5-5 TOR		
5.5-6 TOR		
5.5-S6 TOR	500	3V-1614D
5.5-8 TOR		
5.5-9 TOR	500	3V-1210N
V5.5-S3 TOR		
V5.5-S4 TOR		
V5.5-4 TOR		
V5.5-5 TOR		
V5.5-6 TOR		
V5.5-8 TOR	500	3V-1210N
FV5.5-S3 TOR		
FV5.5-3 TOR		
FV5.5-S4 TOR		
FV5.5-4 TOR		
FV5.5-5 TOR		
FV5.5-6 TOR	500	3V-1210N
FV5.5-S6 TOR		
FV5.5-S8 TOR		
FVX5.5-S4 TOR		
FVX5.5-5 TOR	500	3V-1210N
FVX5.5-8 TOR		
FVL5.5-S3 TOR		
FVL5.5-S4 TOR	500	3V-1210N
FVL5.5-4 TOR		
FVL5.5-5 TOR		
FVL5.5-6 TOR	500	3V-1210N
N5.5-S4 TOR		
N5.5-4 TOR		
N5.5-5 TOR		
N5.5-8 TOR	500	3V-1210N
VD5.5-S3 TOR		
VD5.5-S4 TOR		
VD5.5-4 TOR		
VD5.5-5 TOR	500	3V-1210N
FVD5.5-S4 TOR		
FVD5.5-4 TOR		
FVD5.5-5 TOR		
FVD5.5-6 TOR	500	3V-1210N
FVD5.5-S8 TOR		
FND5.5-10 TOR		

Note:1) Delivery lead times may vary depending on the product.
Contact JST for details.

Tape-on terminals/splices



SPADE TONGUE TERMINAL



Order No.	Q'ty/reel	Die set No.
1.25-B3A TOR	1,000	3H-2216
1.25-YS3A TOR		
1.25-S3A TOR		
1.25-N3A TOR		
1.25-M3A TOR		
1.25-YS4A TOR		
1.25-S4A TOR		
1.25-4A TOR		
1.25-5A TOR		
1.25-M5A TOR		
1.25-C3A TOR		
V1.25-B3A TOR		
V1.25-YS3A TOR		
V1.25-S3A TOR		
V1.25-YS4A TOR		
V1.25-S4A TOR		
V1.25-4A TOR		
V1.25-5A TOR	1,000	3V-2216N
FV1.25-YS3A TOR		
FV1.25-S3A TOR		
FV1.25-YS4A TOR		
FV1.25-S4A TOR	1,000	3V-2216N
FN1.25-S4A TOR	1,000	3V-2216N
FVL1.25-YS3A TOR	1,000	3V-2216N
FVL1.25-P3A TOR		
FVL1.25-S4A TOR		

Note:1) Delivery lead times may vary depending on the product.
Contact JST for details.

Order No.	Q'ty/reel	Die set No.
VD1.25-4A TOR	1,000	3V-2216D
FVD1.25-B3A TOR	1,000	3V-2216D
FVD1.25-YS3A TOR		
FVD1.25-S3A TOR		
FVD1.25-S4A TOR		
FND1.25-5A TOR	1,000	3H-2216D
2-N3A TOR	1,000	3H-1614
2-YS3A TOR		
2-YS4A TOR		
2-S4A TOR		
2-4A TOR		
2-5A TOR		
V2-YS3A TOR	1,000	3V-1614N
V2-4A TOR	1,000	3V-1614N
FV2-YS3A TOR		
FV2-S3A TOR		
FV2-4A TOR		
FV2-5A TOR	1,000	3V-1614D
FVD2-4A TOR	1,000	3V-1614D
5.5-S3A TOR	1,000	3H-1210N
5.5-S4A TOR		
5.5-5A TOR		
FV5.5-S3A TOR	500	3V-1210N
FV5.5-5A TOR	500	3V-1210N
FVL5.5-S3A TOR		

Note:1) Delivery lead times may vary depending on the product.
Contact JST for details.

Tape-on terminals/splices

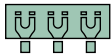

FLANGED SPADE TONGUE TERMINAL

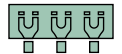

Order No.	Q'ty/reel	Die set No.
1.25-S3B TOR	1,000	3H-2216
1.25-S4B TOR		
V1.25-S3B TOR	1,000	3V-2216N
V1.25-S4B TOR		
FND1.25-S3B TOR	1,000	3V-2216D
2-S4B TOR	1,000	3H-1614
2-T4B TOR		
FV2-S3B TOR	1,000	3V-1614N
N2-T4B TOR	1,000	3V-1614N

Note:1) Delivery lead times may vary depending on the product.
Contact JST for details.

Order No.	Q'ty/reel	Die set No.
FVD2-T3B TOR	1,000	3V-1614D
5.5-S4B TOR	1,000	3H-1210N
5.5-S5B TOR		
5.5-5B TOR		
V5.5-S4B TOR	500	3V-1210N
FV5.5-3B TOR	500	3V-1210N
FV5.5-4B TOR		
N5.5-S4B TOR	500	3V-1210N
FVX5.5-S4B TOR	500	3V-1210N

Note:1) Delivery lead times may vary depending on the product.
Contact JST for details.

Tape-on terminals/splices

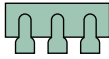

CLOSED-END SPLICE

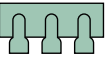

Order No.	Q'ty/reel	Die set No.
1-SD TOR	500	3S-2218D
2-SD TOR		3S-1614D
5.5-SD TOR	400	3S-1210D
CE1 TOR	500	Not available
CE2 TOR		
CE5 TOR		
CE5 TOR	400	

Note:1) Delivery lead times may vary depending on the product.
Contact JST for details.

Tape-on terminals/splices

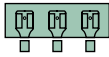

QUICK DISCONNECT TERMINAL *Vinyl-insulated with copper sleeve*

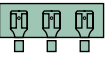

Order No.	Q'ty/reel	Die set No.
FVDDF1.25-110A-5 TOR	1,000	3V-2216N
FVDDF1.25-110A-8 TOR		
FVDDF1.25-187A-5 TOR		
FVDDF1.25-187A-8 TOR		
FVDDF2-187A-5 TOR	1,000	3V-1614N
FVDDF2-205A-8 TOR		
FVDDF1.25-250A TOR	1,000	3V-2216N
FVDDF2-250A TOR	1,000	3V-1614N
FVDDF5.5-250A TOR	500	3V-1210N
FVDDF1.25-250B TOR	1,000	3V-2216N
FVDDF2-250B TOR	1,000	3V-1614N
FVDDF5.5-250B TOR	500	3V-1210N
FVZDF1.25-110A-5 TOR	1,000	3V-2216N
FVZDF1.25-110A-8 TOR		
FVZDF1.25-187A-5 TOR		
FVZDF1.25-187A-8 TOR		
FVZDF1.25-250A TOR	1,000	3V-1614N
FVZDF2-187A-5 TOR		
FVZDF2-187A-8 TOR		
FVZDF2-250A TOR		

Note:1) Delivery lead times may vary depending on the product.
Contact JST for details.

Order No.	Q'ty/reel	Die set No.
LVDDF1.25-187A-5 TOR	500	3V-2216N
LVDDF1.25-187A-8 TOR		
LVDDF2-187A-5 TOR	500	3V-1614N
LVDDF2-187A-8 TOR		
LVDDF1.25-250A TOR	500	3V-2216N
LVDDF2-250A TOR	500	3V-1614N
LVDDF5.5-250A TOR	500	3V-1210N
FLVDDF1.25-187A-5 TOR	500	3V-2216N
FLVDDF1.25-187A-8 TOR		
FLVDDF2-187A-5 TOR	500	3V-1614N
FLVDDF2-187A-8 TOR		
FLVDDF1.25-250A TOR	500	3V-2216N
FLVDDF2-250A TOR	500	3V-1614N
FLVZDF1.25-187A-5 TOR	500	3V-2216N
FLVZDF1.25-187A-8 TOR		
FLVZDF2-187A-5 TOR	500	3V-1614N
FLVZDF2-187A-8 TOR		
FLVZDF1.25-250A TOR	500	3V-2216N
FLVZDF2-250A TOR	500	3V-1614N
FVDDM1.25-250 TOR	1,000	3V-2216N
FVDDM2-250 TOR	1,000	3V-1614N

Note:1) Delivery lead times may vary depending on the product.
Contact JST for details.