

Features

- ✧ UL Recognized File # E-326243
- ✧ High efficiency, low VF.
- ✧ High current capability
- ✧ High reliability
- ✧ High surge current capability
- ✧ Low power loss.
- ✧ For use in low voltage, high frequency inverter, free wheeling, and polarity protection application
- ✧ Green compound with suffix "G" on packing code & prefix "G" on datecode.



Mechanical Data

- ✧ Cases: ITO-220AC molded plastic
- ✧ Epoxy: UL 94V-0 rate flame retardant
- ✧ Terminals: Pure tin plated, lead free, solderable per MIL-STD-202, Method 208 guaranteed
- ✧ Polarity: As marked
- ✧ High temperature soldering guaranteed: 260°C/10 seconds
- ✧ Weight: 1.70 grams

Ordering Information(example)

Part No.	Package	Packing	Packing code	Packing code (Green)
SFAF1001G	ITO-220AC	50 / TUBE	C0	C0G

Maximum Ratings and Electrical Characteristics

Rating at 25 °C ambient temperature unless otherwise specified.

Parameter	Symbol	SFAF 1001G	SFAF 1002G	SFAF 1003G	SFAF 1004G	SFAF 1005G	SFAF 1006G	SFAF 1007G	SFAF 1008G	Units
Maximum Recurrent Peak Reverse Voltage	V_{RRM}	50	100	150	200	300	400	500	600	V
Maximum RMS Voltage	V_{RMS}	35	70	105	140	210	280	350	420	V
Maximum DC Blocking Voltage	V_{DC}	50	100	150	200	300	400	500	600	V
Maximum Average Forward Rectified Current	$I_{F(AV)}$	10								A
Peak Forward Surge Current, 8.3 ms Single Half Sine-wave Superimposed on Rated Load (JEDEC method)	I_{FSM}	150								A
Maximum Instantaneous Forward Voltage (Note 1) @ 10 A	V_F	0.975			1.3		1.7			V
Maximum DC Reverse Current @ $T_A=25\text{ }^\circ\text{C}$ at Rated DC Blocking Voltage @ $T_A=100\text{ }^\circ\text{C}$	I_R	10				400				uA uA
Maximum Reverse Recovery Time (Note 2)	T_{rr}	35								nS
Typical Junction Capacitance (Note 3)	C_j	170				140				pF
Typical Thermal Resistance	$R_{\theta JC}$	4								$^\circ\text{C/W}$
Operating Temperature Range	T_J	- 65 to + 150								$^\circ\text{C}$
Storage Temperature Range	T_{STG}	- 65 to + 150								$^\circ\text{C}$

Note 1: Pulse Test with PW=300 usec, 1% Duty Cycle

Note 2: Reverse Recovery Test Conditions: $I_F=0.5A$, $I_R=1.0A$, $I_{RR}=0.25A$.

Note 3: Measured at 1 MHz and Applied Reverse Voltage of 4.0V D.C.

RATINGS AND CHARACTERISTIC CURVES (SFAF1001G THRU SFAF1008G)

FIG. 1- MAXIMUM FORWARD CURRENT DERATING CURVE

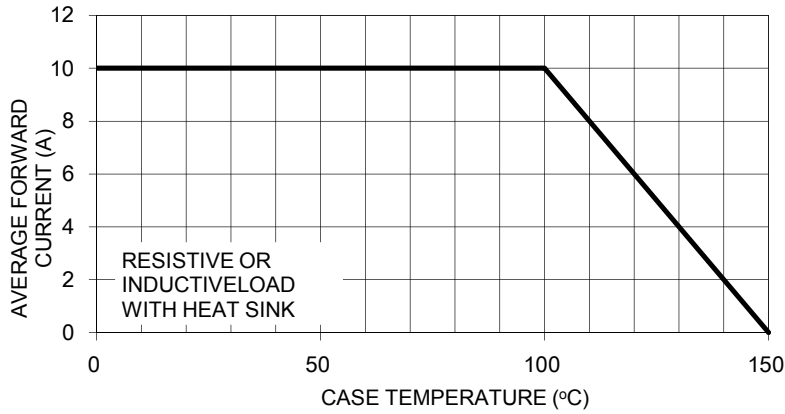

FIG. 2- TYPICAL REVERSE CHARACTERISTICS

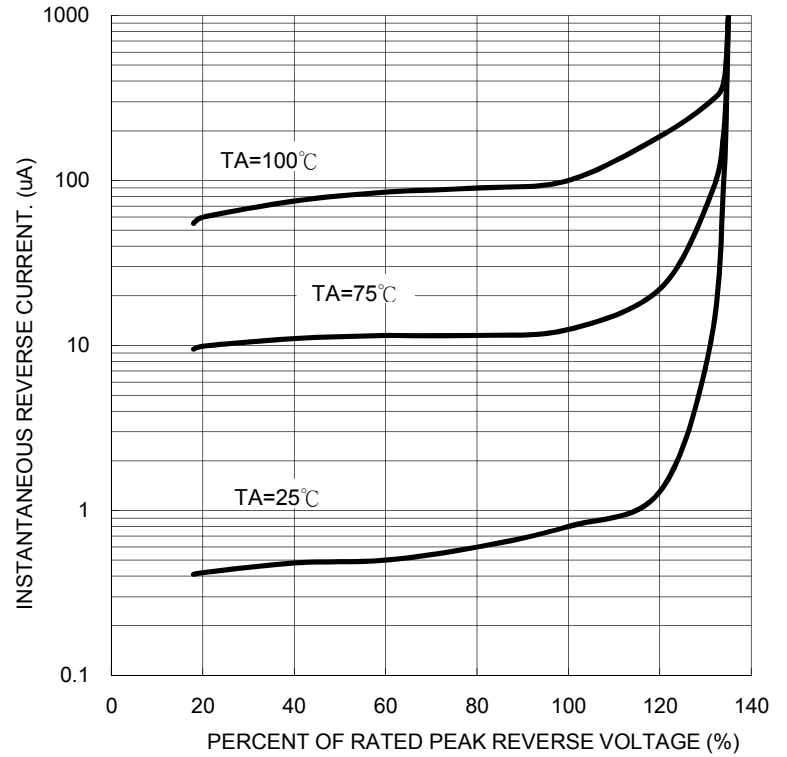

FIG. 3- MAXIMUM NON-REPETITIVE FORWARD SURGE CURRENT

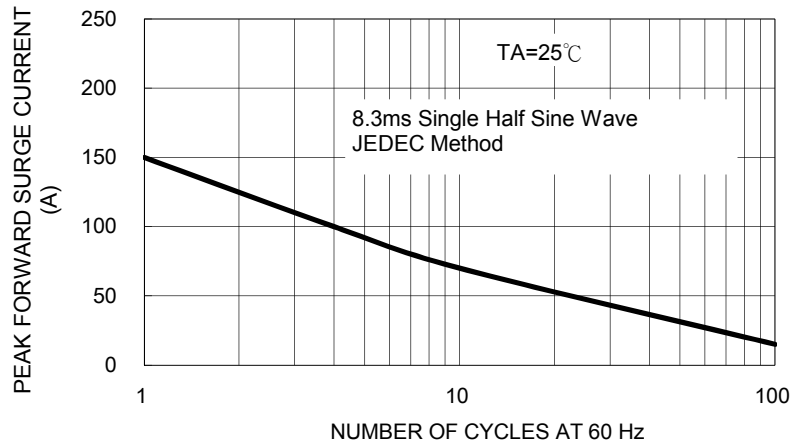

FIG. 5- TYPICAL FORWARD CHARACTERISTICS

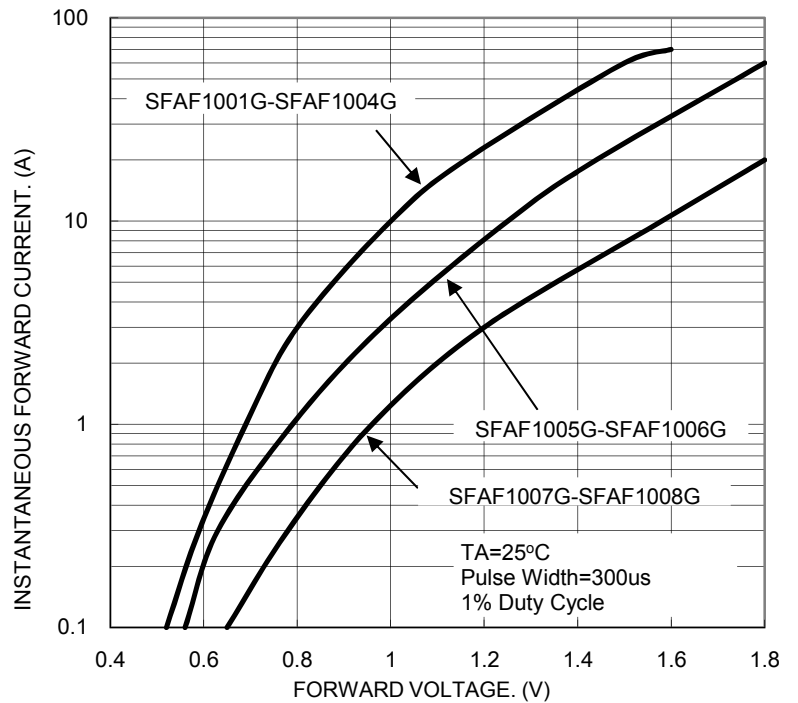

FIG. 4- TYPICAL JUNCTION CAPACITANCE

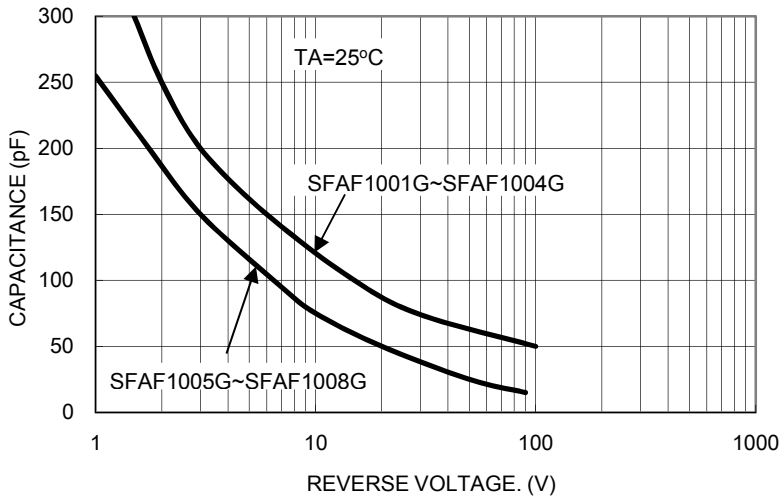
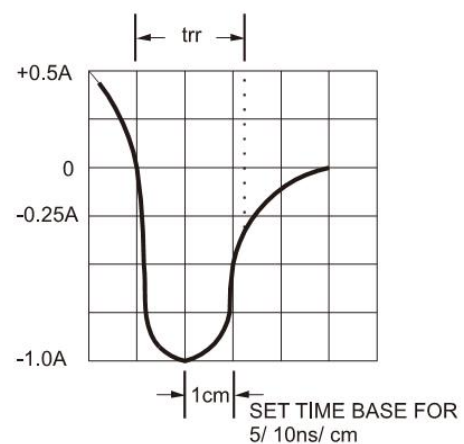
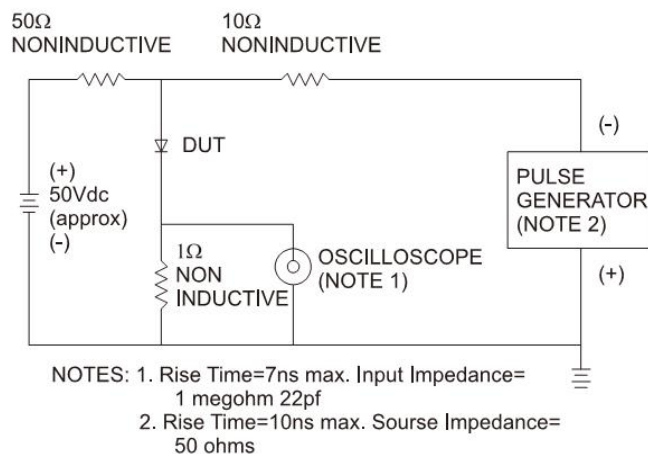

FIG. 6- REVERSE RECOVERY TIME CHARACTERISTIC AND TEST CIRCUIT DIAGRAM



Ordering information

Part No.	Package	BULK Packing	Packing code	Packing code (Green)
SFAF100xG	ITO-220AC	50 / TUBE	C0	C0G

Note: "x" is Device Code from "1" thru "8".

Dimensions

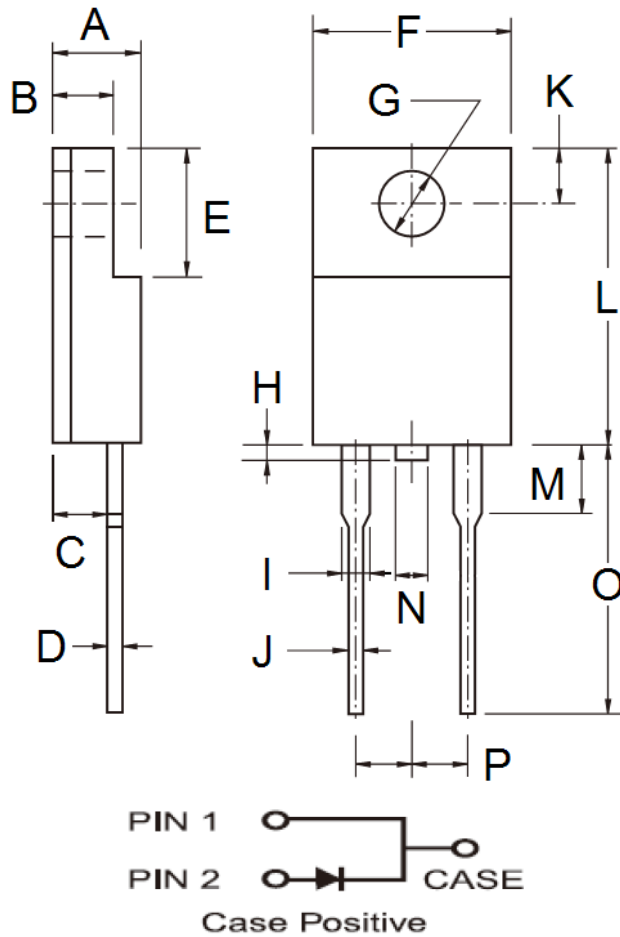

DIM.	Unit(mm)		Unit(inch)	
	Min	Max	Min	Max
A	4.30	4.70	0.169	0.185
B	2.50	3.10	0.098	0.122
C	2.30	2.90	0.091	0.114
D	0.46	0.76	0.018	0.030
E	6.30	6.90	0.248	0.272
F	9.60	10.30	0.378	0.406
G	3.00	3.40	0.118	0.134
H	-	1.60	-	0.063
I	0.95	1.45	0.037	0.057
J	0.50	0.90	0.020	0.035
K	2.40	3.20	0.094	0.126
L	14.80	15.50	0.583	0.610
M	-	4.10	-	0.161
N	-	1.80	-	0.071
O	12.60	13.80	0.496	0.543
P	4.95	5.20	0.195	0.205

Marking Diagram



P/N = Specific Device Code
 G = Green Compound
 YWW = Date Code