

MC8T14
0 to 70°C
L Suffix — Case 620
P Suffix — Case 648

MC8T24
0 to 70°C
L Suffix — Case 620
P Suffix — Case 648

MC8T14 is a triple-hysteresis-equipped receiver. Specified for general TTL Systems.

MC8T24 is a triple-hysteresis-equipped receiver specified to meet IBM System requirements.

Device Number	V _H (R) Volts Min.	I _H (R) (or V _{IH} (R) = 3.8 V or V _{IH} (R) = 3.11 V* mA Max.	t _{PLH} (R) (or C _L = 15 pF ns Max.
MC8T14	0.3	0.17	30
MC8T24	0.2	0.17*	30

MINICOMPUTER BUS

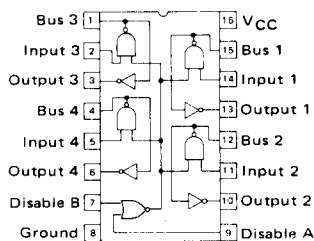

MC3436
0 to 70°C
L Suffix — Case 620
P Suffix — Case 648

Quad Transceivers with hysteresis-equipped receivers and open-collector driver outputs which permit wire-OR connection (DM8838 equivalent).

Receiver Hysteresis Volts Min.	V _L (BUS) (or I _{BUS} = 50 mA) Volts Max.	I _{BUS} (or V _{IH} (BUS) = 4.0 V) μA Max.	t _{PLH} (D) (or C _L = 15 pF ns Max.	t _{PLH} (R) (or C _L = 15 pF ns Max.
0.25	0.7	100	25	30

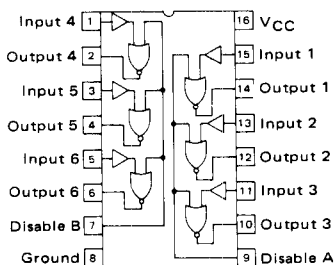

MC3437
0 to 70°C
L Suffix — Case 620
P Suffix — Case 648

Hex Receivers with Hysteresis for improved noise immunity (DM8837 equivalent)

I _I (R) (or V _I (R) = 4.0 V) μA Max.	Hysteresis Volts Min.	t _{PLH} (R) (or C _L = 15 pF ns Max.
50	0.5	30

MICROPROCESSOR BUS

The revolutionary "Computer on a Chip" is another bus organized system. The requirements on the microprocessor bus are especially stringent. Generally, microprocessors (MPUs) are fabricated utilizing MOS technology with its attendant high circuit density characteristics. However, MOS structures become unduly large when it is necessary to conduct large amounts of current. Therefore it is necessary that each of the elements attached to the MPU systems can tolerate a total loading equal to only about one conventional TTL load.

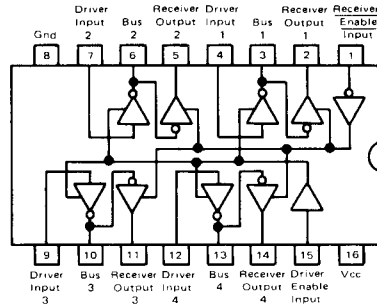

MC8T20/MC6880
0 to +75°C
L Suffix — Case 620
P Suffix — Case 648

Quad three-state bus transceiver

I _H and I _L Input Current (Either Logic State) μA	I _{OHL} Output Disabled Leakage Current — High Logic State Max. μA	t _{PLH} , t _{PHL} Propag. Delay Time — High to Low or Low to High ns Max.
200	100	17

INSTRUMENTATION BUS

Steps toward standardization of the instrumentation interface bus have been made by the International Electrotechnical Commission (IEC) and the IEEE with Standard 488-1975. Acceptance of these standards will permit interconnection of many types of measurement apparatus, manufactured by numerous firms, into complex systems simply by plugging in connecting cables.

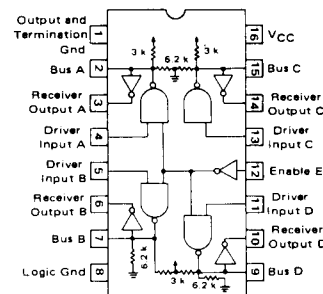

MC3440
0 to 70°C
P Suffix — Case 648

Quad Transceivers with 3 Drivers Sharing a Common Enable Input
R1 = 3.0 k (to V_{CC})
R2 = 6.2 k (to Gnd)

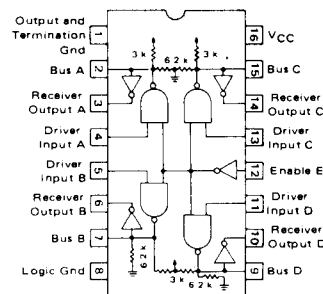

MC3441
0 to 70°C
P Suffix — Case 648

Quad Transceivers with all four drivers controlled by a Common-Enable Input
R1 = 3.0 k (to V_{CC})
R2 = 6.2 k (to Gnd)

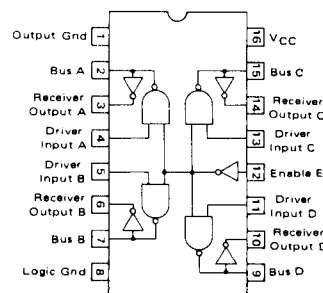

MC3443
0 to 70°C
P Suffix — Case 648

Quad Transceivers without termination resistors. Functional equivalent to 75138

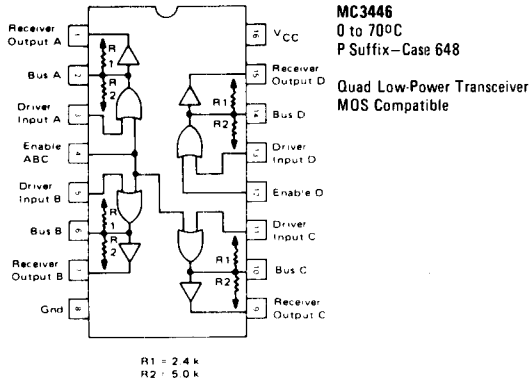

Device Number	Receiver Input Hysteresis mV Min.	Drive Output Voltage @ I _{OL} = 48 mA Volts Max.	Bus Divider Voltage Volts	t _{PHL} (Driver or Receiver) ns Max.
MC3440	400	0.4	2.6 to 3.75	30
MC3441	400	0.4	2.6 to 3.75	30
MC3443	400	0.4	—	25(D) 22(R)
MC3446	400	0.4	2.5 to 3.7	50(D) 40(R)

COMMUNICATION INTERFACE

Low cost solid-state crosspoint switches offer important advantages in modern telephone exchanges.

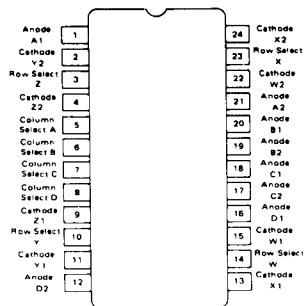

t _{off} @ V _{AK} = 10 V MΩ Min.	t _{on} @ I _{AK} = 20 mA Ohms Max.	BV _{AK} BV _{KA} Volts Min.	V _{AK} V _{KA} @ I _{AK} = 20 mA Volts Max.
100	10	25	1.1

COMPUTER AND TERMINAL INTERFACE

Important interfaces are present in computers and computer terminals.

DRIVERS AND RECEIVERS

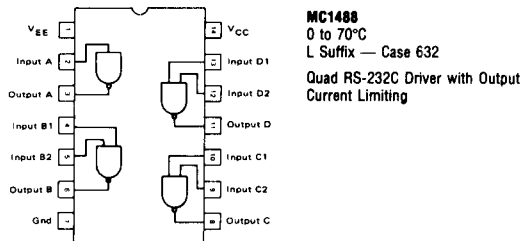

V _{OH} @ V _{CC} /V _{EE} = ±9.0 V Volts Min.	V _{OL} @ V _{CC} /V _{EE} = ±9.0 V Volts Max.	I _{OS} mA Range	t _{PHL} @ C _L = 15 pF ns Max.
6.0	-6.0	±6.0 to 12	175

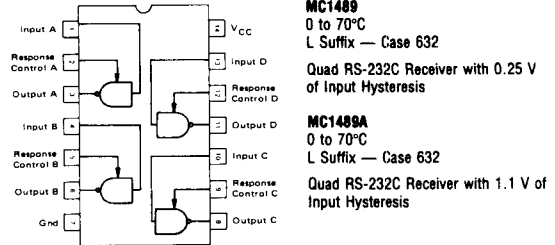

Device Number	Input V _{IHL} Volts Range	Input V _{IHL} Volts Range	t _{PHL} @ R _L = 390Ω ns Max.
MC1489	1.0 to 1.5	0.75 to 1.25	50
MC1489A	1.75 to 2.25	0.75 to 1.25	50

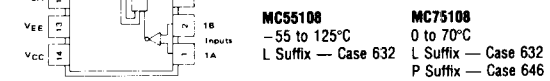
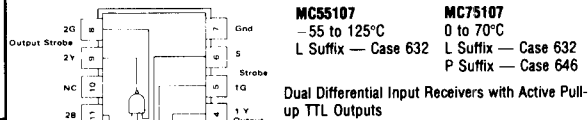

Input V _{TH} mV Max.	I _{IH} @ V _{ID} = 0.5 V μA Max.	I _{IL} @ V _{ID} = -2.0 V μA Max.	t _{PLH} ns Max.
±25	75	-10	25

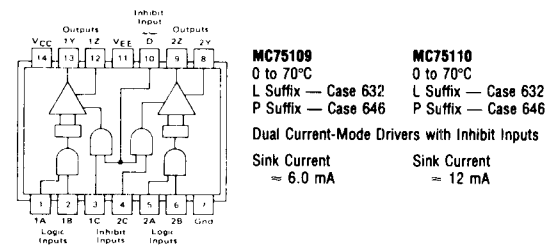

Device Number	I _{on} (ON) mA Max.	I _O (OFF) μA Max.	t _{PHL} ns Max.
MC75109	3.5	100	15
MC75110	6.5	100	15

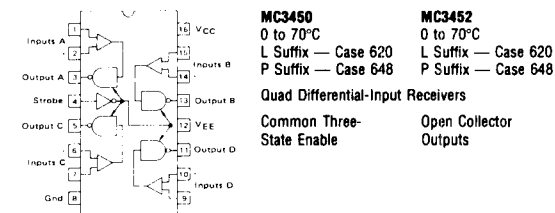

Input V _{TH} mV Max.	I _{IH} @ V _{ID} = 0.5 V μA Max.	I _{IL} @ V _{ID} = -2.0 V μA Max.	t _{PLH} ns Max.
±25	75	-10	25