

LCD Module Specification

Model: LG2401281-BMDWH6V

Table of Contents

● COVER & CONTENTS	1
● BASIC SPECIFICATIONS	2
● ABSOLUTE MAXIMUM RATINGS	3
● ELECTRICAL CHARACTERISTICS	4
● COMMUNICATION WITH MPU	7
● COMMAND DEFINITIONS	11
● INITIALIZATION	23
● CHARACTER GENERATOR	24
● ELECTRO—OPTICAL CHARACTERISTICS	26
● DIMENSIONAL OUTLINE	28
● LCD MODULE NUMBERING SYSTEM	29
● PRECAUTIONS FOR USE OF LCD MODULE	30

1. BASIC SPECIFICATIONS

1.1 Features

- Display Format : 240 X 128 Dots
- LCD Mode : STN—Blue—Negative—Transmissive
- Driving Method : 1/128 Duty, 1/12 Bias
- Viewing Direction : 6:00
- Backlight : LED, white color
- Outline Dimension : 144.0(W) X 104.0(H) X 14.0(T) mm
- Viewing Area : 114.0(W) X 64.0(H) mm
- Dot Size : 0.40 X 0.40 mm
- Dot Pitch : 0.45 X 0.45 mm
- Weight : 190 g
- Controller : T6963C
- Display RAM : 32K Bytes
- Others : 128 words character generator ROM
 256 words (max.) character generator RAM
 6x8 or 8x8 font selectable
 Text, graphic and combination of text/graphic display

1.2 Block Diagram

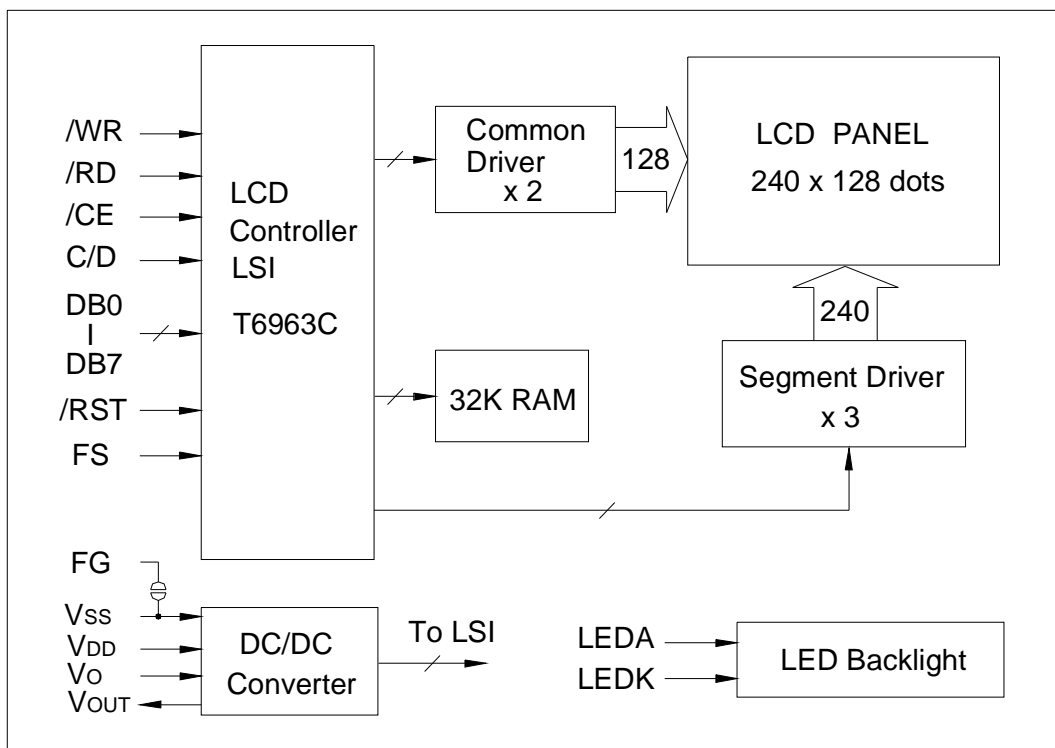

1.3 Terminal Functions

Pin No.	Symbol	Level	Function
1	FG	--	Frame ground
2	VSS	0V	Ground
3	VDD	+5V	Power supply for logic
4	VO	--	Operating voltage for LCD (Contrast adjusting)
5	/WR	L	Write signal, active "L"
6	/RD	L	Read signal, active "L"
7	/CE	L	Chip enable signal, active "L"
8	C/D	H/L	Write mode H: Command write L: Data write Read mode H: Status read L: Data read
9	NC	--	No connection
10	/RST	L	Reset signal, active "L"
11	DB0	H/L	Data bit0
12	DB1	H/L	Data bit1
13	DB2	H/L	Data bit2
14	DB3	H/L	Data bit3
15	DB4	H/L	Data bit4
16	DB5	H/L	Data bit5
17	DB6	H/L	Data bit6
18	DB7	H/L	Data bit7
19	FS	H/L	Font selection H: 6x8 dots L: 8x8 dots
20	VOUT	-15V	Output voltage for LCD driving
21, 33, 35	LEDA	+5V	Power supply for LED backlight
22, 34, 37	LEDK	0V	Power supply for LED backlight
23~32, 36	NC	--	No connection

2. ABSOLUTE MAXIMUM RATINGS

Item	Symbol	Min.	Max.	Unit
Supply Voltage(Logic)	VDD-VSS	-0.3	7.0	V
Supply Voltage(LCD)	VDD-VO	-0.3	28.0	V
Input Voltage	VI	-0.3	VDD+0.3	V
Operating Temp.	Topr	-20	70	°C
Storage Temp.	Tstg	-30	80	°C

3. ELECTRICAL CHARACTERISTICS

3.1 DC Characteristics

(VDD=5.0V±10%, Ta=25°C)

Item	Symbol	Condition	Min.	Typ.	Max.	Unit
Supply Voltage (Logic)	VDD		4.5	5.0	5.5	V
Supply Voltage (LCD Drive)	VDD-VO		--	18.0	--	V
Input High Voltage	VIH		VDD-2.2	--	VDD	V
Input Low Voltage	VIL		0	--	0.8	V
Output High Voltage	VOH	IOH=-0.75mA	VDD-0.3	--	VDD	V
Output Low Voltage	VOL	IOL=0.75mA	0	--	0.3	V
Supply Current (Logic)	IDD	VDD=5.0V	--	18.0	25.0	mA

3.2 AC Timing Chart

(VDD=5.0V±10%, Ta=25°C)

Characteristic	Symbol	Min.	Max.	Unit
C/D Setup Time	t _{CDS}	100	--	ns
C/D Hold Time	t _{CDH}	10	--	ns
/CE, /RD, /WR Pulse Width	t _{CE} , t _{RD} , t _{WR} ,	80	--	ns
Data Setup Time	t _{DS}	80	--	ns
Data Hold Time	t _{DH}	40	--	ns
Access Time	t _{ACC}	--	150	ns
Output Hold Time	t _{OH}	10	50	ns

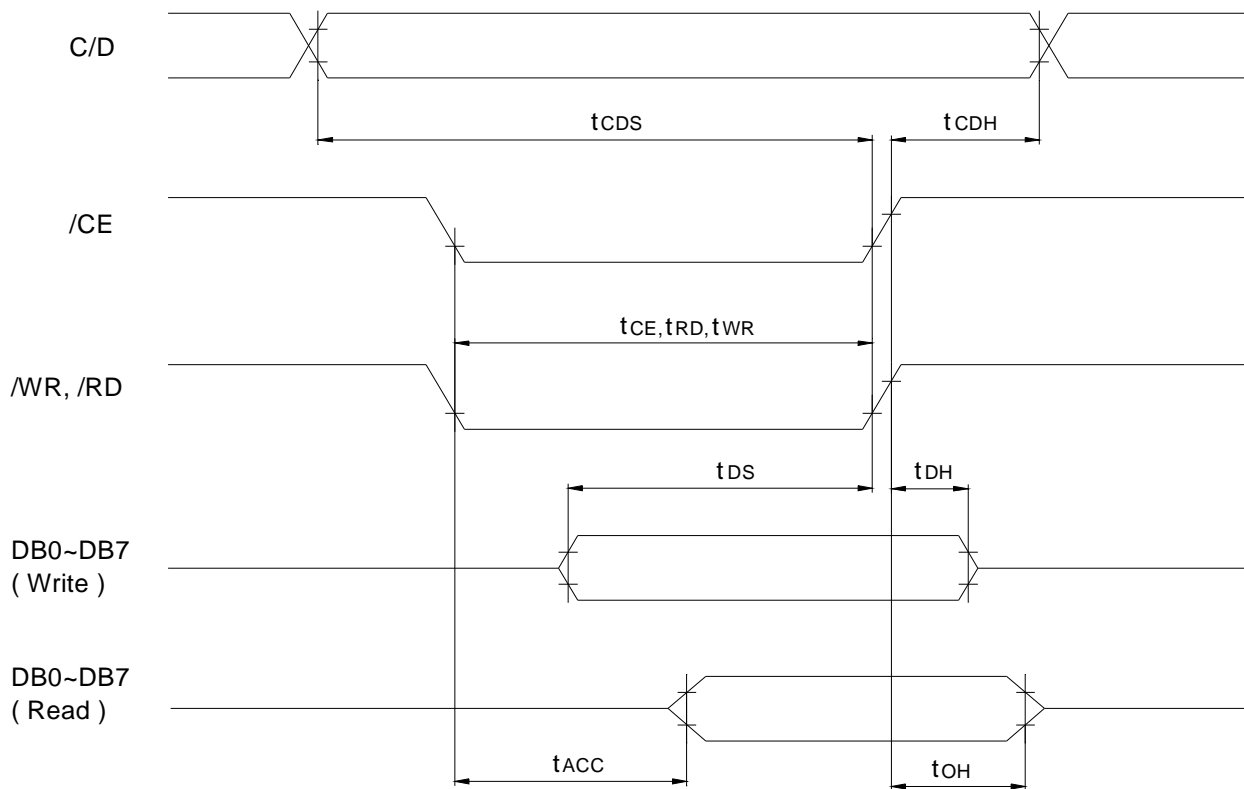
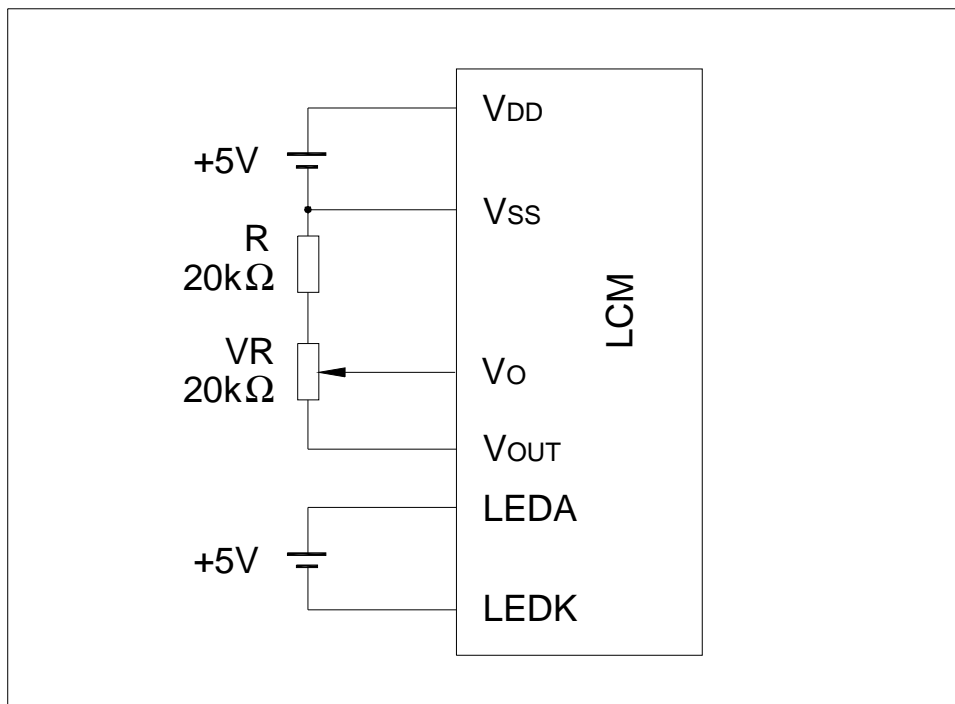

Fig.1 Bus Read/Write Timing

3.3 LED Backlight Characteristics (Ta=25°C)

Item	Symbol	Condition	Min.	Typ.	Max.	Unit
Forward Voltage	Vf		2.9	3.1	3.3	V
Forward Current	If	Vf=3.1V	--	105	--	mA
Color	White					

3.4 Power Supply



Note: 5V voltage for the LED backlight should be supplied to Pin21 (or Pin 33, Pin35) and Pin22 (or Pin34, Pin37) terminal of the interface, it should not be supplied to the Anode/Cathode terminal of the LED backlight directly.

4. COMMUNICATION WITH MPU

4.1 RAM Map

The Display RAM is built in the module, and display data (text, graphic and CG data) is written to this display RAM. The built-in controller T6963C automatically reads the display RAM and sends the appropriate data to LCD drivers. The “Control Word Set” command (text home set, text area set, etc.) defines the RAM area which is read by the controller T6963C making the RAM map programmable by the user. If more than 1 screen can be stored in the RAM. Vertical scrolling and paging is easily performed by resetting text home and/or graphic home address.

The 32K bytes built-in RAM is located at address 0000H ~ 7FFFH, and the following is an example of RAM mapping.

0000H	Graphic RAM Area (0000H ~ 3BFFH)	GH=0000H * 6 x 8 Font=3 screen * 8 x 8 Font=4 screen
3C00H		
	Attribute RAM Area (3C00H ~ 3FFFH)	Text for 1024 characters
4000H	Text RAM Area (4000H ~ 7BFFH)	TH=4000H * 6 x 8 Font=24 screen * 8 x 8 Font=32 screen
7C00H		
	CG RAM Area (7C00H ~7FFFH)	CG RAM Offset register For 128 words, set data="0FH"
7FFFH		

4.2 Status Read

Status of the T6963C should be checked between all command and data in order to complete a communication cycle with the MPU. The status can be read from 8 bits data lines (D0 to D7) by setting C/D="H", /RD="L", /WR="H" and /CE="L".

The T6963C status word format is as follows:

MSB				LSB			
STA7	STA6	STA5	STA4	STA3	STA2	STA1	STA0
D7	D6	D5	D4	D3	D2	D1	D0

STA0	Check command execution capability	0 : Disable 1 : Enable
STA1	Check data read/write capability	0 : Disable 1 : Enable
STA2	Check Auto mode data read capability	0 : Disable 1 : Enable
STA3	Check Auto mode data write capability	0 : Disable 1 : Enable
STA4	Not used	
STA5	Check controller operation capability	0 : Disable 1 : Enable
STA6	Error flag. Used for Screen Peek and Screen Copy commands.	0 : No error 1 : Error
STA7	Check the blink condition	0 : Display off 1 : Normal display

(Note 1) It is necessary to check STA0 and STA1 at the same time.

(Note 2) For most modes STA0/STA1 are used as a status check.

(Note 3) STA2 and STA3 are used in Auto mode.

Status checking flow

a) Status check 1

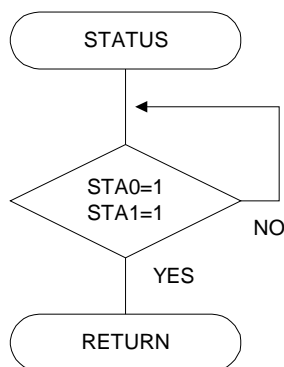

b) Status check 2

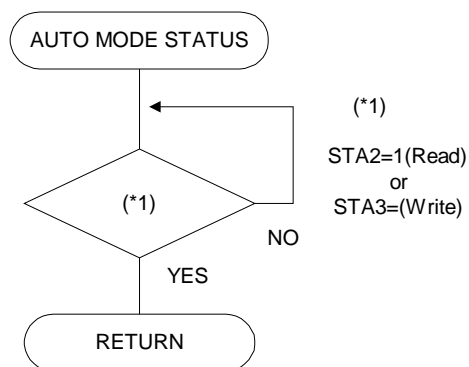

4.3 Setting data

When using a command with operand data, first send the data, then send the command.

Procedure for sending a command

1) Command with 1 byte data

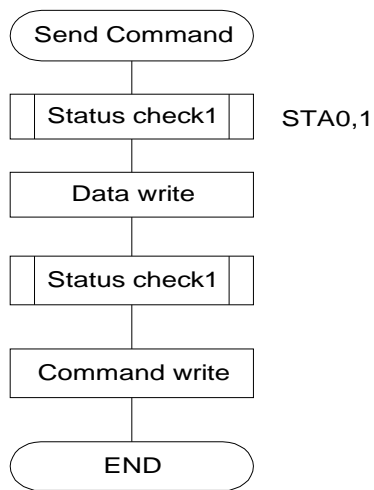

2) Command with 2 bytes data

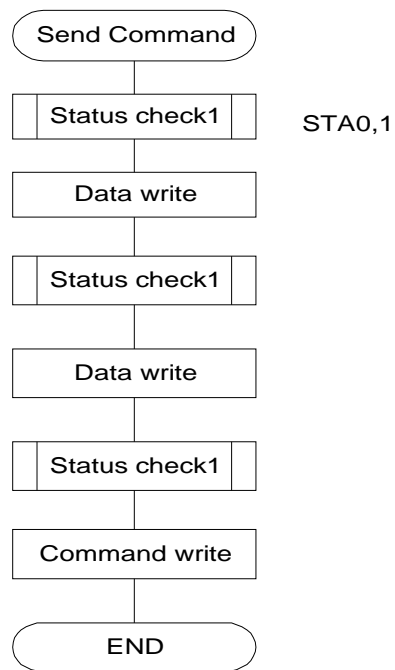

3) Command with no data

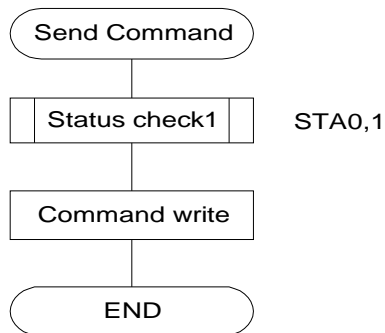

(Note) When sending more than two data, the last datum (or last two data) is valid.

4.4 Connection with 8051 Family MPU

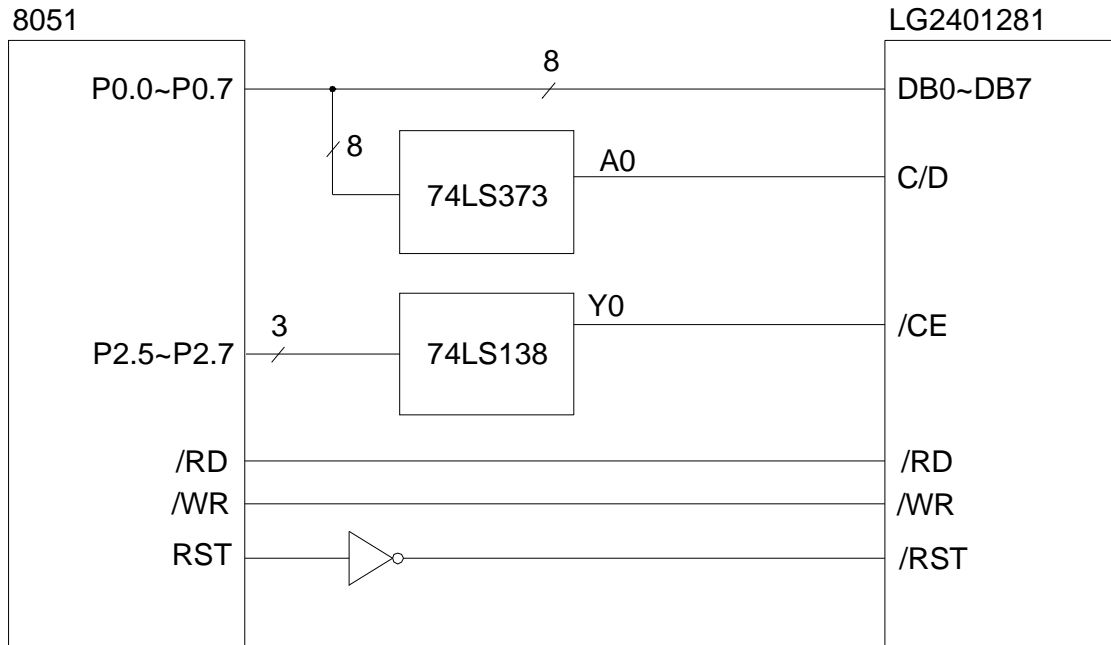

a. Application Circuit 1

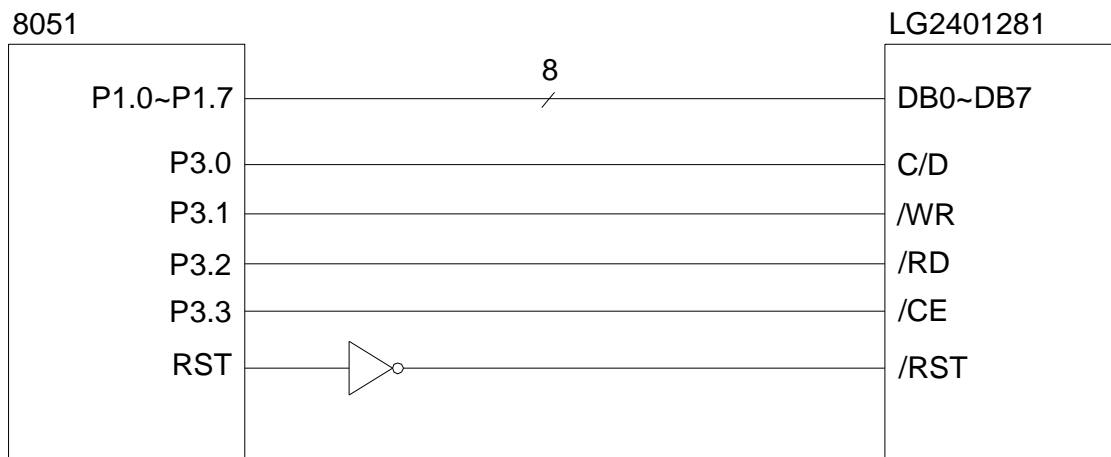

b. Application Circuit 2

5. COMMAND DEFINITIONS

COMMAND	CODE	D1	D2	FUNCTION
REGISTERS SETTING	00100001	X address	Y address	Set Cursor Pointer
	00100010	Data	00H	Set Offset Register
	00100100	Low address	High address	Set Address Pointer
SET CONTROL WORD	01000000	Low address	High address	Set Text Home Address
	01000001	Columns	00H	Set Text Area
	01000010	Low address	High address	Set Graphic Home Address
	01000011	Columns	00H	Set Graphic Area
MODE SET	1000X000	--	--	OR mode
	1000X001	--	--	EXOR mode
	1000X011	--	--	AND mode
	1000X100	--	--	Text Attribute mode
	10000XXX	--	--	CG ROM mode
	10001XXX	--	--	CG RAM mode
DISPLAY MODE	10010000	--	--	Display off
	1001XX10	--	--	Cursor on, blink off
	1001XX11	--	--	Cursor on, blink on
	100101XX	--	--	Text on, graphic off
	100110XX	--	--	Text off, graphic on
	100111XX	--	--	Text on, graphic on
CURSOR PATTERN SELECT	10100000	--	--	1-line cursor
	10100001	--	--	2-line cursor
	10100010	--	--	3-line cursor
	10100011	--	--	4-line cursor
	10100100	--	--	5-line cursor
	10100101	--	--	6-line cursor
	10100110	--	--	7-line cursor
	10100111	--	--	8-line cursor
DATA AUTO READ/ WRITE	10110000	--	--	Set Data Auto Write
	10110001	--	--	Set Data Auto Read
	10110010	--	--	Auto Reset
DATA READ/WRITE	11000000	Data	--	Data Write and Increment ADP
	11000001	--	--	Data Read and Increment ADP
	11000010	Data	--	Data Write and Decrement ADP
	11000011	--	--	Data Read and Decrement ADP
	11000100	Data	--	Data Write and Nonvariable ADP
	11000101	--	--	Data Read and Nonvariable ADP
SCREEN PEEK	11100000	--	--	Screen Peek
SCREEN COPY	11101000	--	--	Screen Copy
BIT SET/RESET	11110XXX			Bit Reset
	11111XXX			Bit Set
	1111X000			Bit 0 (LSB)
	1111X001			Bit 1
	1111X010			Bit 2
	1111X011			Bit 3
	1111X100			Bit 4
	1111X101			Bit 5
	1111X110			Bit 6
	1111X111			Bit 7 (MSB)

X : Don't care

5.1 Set Registers

CODE	HEX.	FUNCTION	D1	D2
00100001	21H	SET CURSOR POINTER	X ADRS	Y ADRS
00100010	22H	SET OFFSET REGISTER	DATA	00H
00100100	24H	SET ADDRESS POINTER	LOW ADRS	HIGH ADRS

5.1.1 Set Cursor Pointer

The position of the cursor is specified by X ADRS AND Y ADRS. The cursor position can only be moved by this command. Data read/write from the MPU never changes the cursor pointer. X ADRS and Y ADRS are specified as follows.

X ADRS: 00H to 4FH, Horizontal cursor position counted by “character”, 6 or 8 dots width.

Y ADRS: 00H to 1FH, Vertical cursor position counted by “character”, 8 dots height.

Note: Please note that the cursor position should be within actual display area.

5.1.2 Set Offset Register

The Set Offset Register command is used to determine the character generator RAM area. The upper 5 bits in start address of CG area is set as the lower 5 bits of D1, and the upper 3 bits of D1 are neglected. D2 should be 00H. Refer to section 7 “Character Generator” for details of the CG RAM.

5.1.3 Set Address Pointer

The Set Address Pointer command is used to indicate the start address for writing/reading data to/from the built-in RAM.

The flowchart for Set Address Pointer command

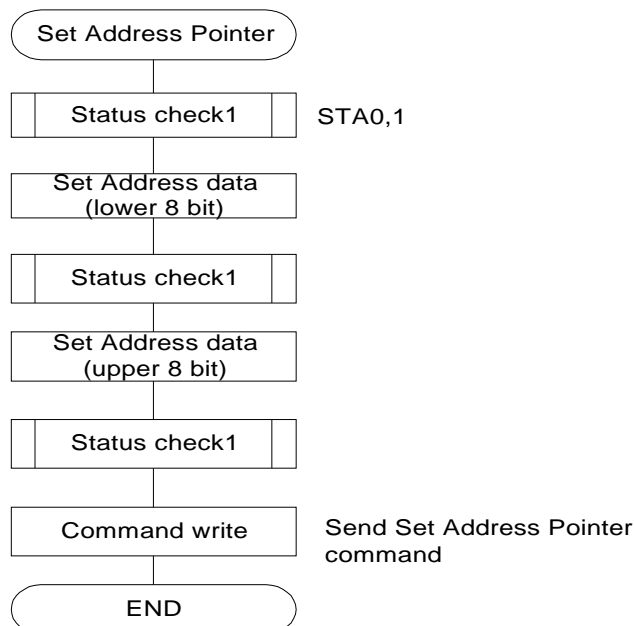

5.2 Set Control Word

CODE	HEX.	FUNCTION	D1	D2
00100000	40H	Set Text Home Address	Low address	High address
00100001	41H	Set Text Area	Columns	00H
00100010	42H	Set Graphic Home Address	Low address	High address
00100011	43H	Set Graphic Area	Columns	00H

The home address of display RAM and column size are defined by this command.

5.2.1 Set Text Home Address (TH)

This command defines the starting address of display RAM for text display. The data in the text home address (TH) is displayed at the home position of display (left end character on 1st row.)

5.2.2 Set Text Area (TA)

This command defines the number of columns by D1. Text area can be defined independently from the number of characters fixed by hardware setting of controller LSI. The text area is usually defined as the actual number of characters on LCD display, so addressing can be continuous in the text area.

The relationship between display RAM address and display position (text display)

a) for 8x8 font: TA=1EH, 30 characters per row

TH	--	TH+1DH
TH+TA	--	TH+TA+1DH
TH+2TA	--	TH+2TA+1DH
--	--	--
TH+15TA	--	TH+15TA+1DH

b) for 6x8 font: TA=28H, 40 characters per row

TH	--	TH+27H
TH+TA	--	TH+TA+27H
TH+2TA	--	TH+2TA+27H
--	--	--
TH+15TA	--	TH+15TA+27H

5.2.3 Set Graphic Home Address (GH)

This command defines the starting address of display RAM for the graphic display. The data in the Graphic home address (GH) is displayed at the home position of display (left end 8 bits in 1st line). When using the attribute function, the graphic home address indicates the starting address of distribute RAM area.

5.2.4 Graphic Address Set (GA)

This command defines the number of columns by D1. The graphic area can be defined independently from the number of characters fixed by hardware setting of controller LSI. If the graphic area is defined as the actual number of columns on the LCD display, the address in graphic area can be continuous and the RAM area can be used without ineffective areas. Note that the Graphic area will be different for depending on character font settings even if horizontal dot number is the same.

The relationship between display RAM address and display position (graphic display)

a) for 8x8 font: GA=1EH, 30x8=240 dots

GH	--	GH+1DH
GH+GA	--	GH+GA+1DH
GH+2GA	--	GH+2GA+1DH
--	--	--
TH+127GA	--	TH+127GA+1DH

8 bits data is as follows:

MSB							LSB
d7	d6	d5	D4	d3	d2	d1	d0

b) for 6x8 font: GA=28H, 40x6=240 dots

GH	--	GH+27H
GH+GA	--	GH+GA+27H
GH+2GA	--	GH+2GA+27H
--	--	--
TH+127GA	--	TH+127GA+27H

8 bits data is as follows:

MSB					LSB		
X	X	d5	D4	d3	d2	d1	d0

X: Invalid data

5.3 Mode Set

CODE	FUNCTION	OPERAND
1000X000	Logically "OR" of Graphic and Text display	--
1000X001	Logically "EXOR" of Graphic and Text display	--
1000X011	Logically "AND" of Graphic and Text display	--
1000X100	Text Attribute Mode	--
10000XXX	CG ROM mode	--
10001XXX	CG RAM mode	--

X : Don't care

Mode set command selects character generator (CG ROM Mode/CG RAM Mode), and combination of text/graphic display. The display mode does not change until the next command is sent. The logical OR, EXOR, AND of text or graphic display can be displayed.

CG ROM mode: Built-in 128 character CG ROM (code: 00H - 7FH) and built-in CG RAM for 128 characters can be used (code: 80H - FFH).

CG RAM mode: Built-in CG RAM for 256 characters (code: 00H - FFH) can be used.

When CG ROM Mode is selected, character code 00H - 7FH is selected from built-in CG ROM and character code 80H - FFH is automatically selected from CG RAM.

(Example)

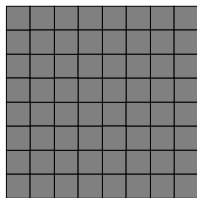

GRAPHIC

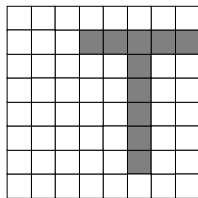

TEXT

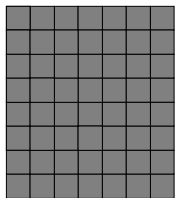

"OR"

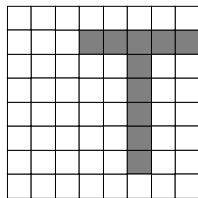

"AND"

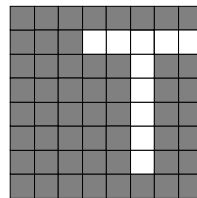

"EXOR"

Attribute function

Attribute operations are “Reverse display”, “Character blink” and “Inhibit” in text display mode. The attribute data is written in the graphic area defined by Set Control Word command (Graphic home address set and Graphic area set). Only text display is possible in Attribute Function mode, since the attribute data is stored in the graphic RAM area, graphic display is automatically disabled. However, the Display Mode command must be used to turn both Text and Graphic on in order for the Attribute function to be available. The attribute data of the 1st character in “Text area” is written at the 1st byte in “graphic area”, and attribute data of nth character is written at the nth byte in “Graphic area”. The attribute function is defined as follows.

Attribute RAM 1 byte

X	X	X	X	d3	d2	d1	d0
---	---	---	---	----	----	----	----

X : Don't care

d3	d2	d1	d0	FUNCTION
0	0	0	0	Normal display
0	1	0	1	Reverse display
0	0	1	1	Inhibit display
1	0	0	0	Blink of normal display
1	1	0	1	Blink of reverse display
1	0	1	1	Blink of inhibit display

5.4 Display Mode

CODE	FUNCTION	OPERAND
10010000	Display off	--
1001XX10	Cursor on, blink off	--
1001XX11	Cursor on, blink on	--
100101XX	Text on, graphic off	--
100110XX	Text off, graphic on	--
100111XX	Text on, graphic on	--

X : Don't care

1	0	0	1	d3	d2	d1	d0
---	---	---	---	----	----	----	----

d0: Cursor blink d0=1: on, d0=0: off

d1: Cursor display d1=1: on, d1=0: off

d2: Text display d2=1: on, d2=0: off

d3: Graphic display d3=1: on, d3=0: off

(Note) It is necessary to turn on "Text display" and "Graphic display" in the following cases: a) Combination of text/graphic display

b) Attribute function

5.5 Cursor Pattern Select

CODE	FUNCTION	OPERAND
10100000	1-line cursor	--
10100001	2-line cursor	--
10100010	3-line cursor	--
10100011	4-line cursor	--
10100100	5-line cursor	--
10100101	6-line cursor	--
10100110	7-line cursor	--
10100111	8-line cursor	--

When cursor display is ON, this command selects the cursor pattern in the range 1 line to 8 lines. The cursor address is defined by the Set Cursor Pointer command.

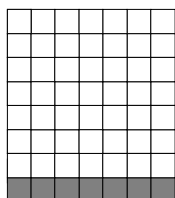

1-line cursor

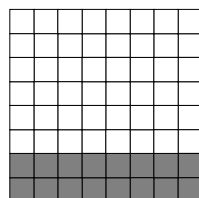

2-line cursor

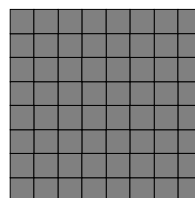

8-line cursor

5.6 Data Auto Read/Write

CODE	HEX.	FUNCTION	OPERAND
10110000	B0H	Set Data Auto Write	--
10110001	B1H	Set Data Auto Read	--
10110010	B2H	Auto Mode Reset	--

This command is convenient to send full screen data, or receive full screen data from built-in RAM. After setting auto mode, a Data Write (or Read) command is not need between each data. Data Auto Write (or Read) command should follow the Address Pointer Set command. After this command, the address pointer is automatically incremented by +1 after each data. After sending (or receiving) all data, Auto Mode Reset command is necessary to return normal operation because all data is regarded “display data” and no command can be accepted in the auto mode.

(Note) Status check for Auto mode (STA2 or STA3) should be checked between each data. Auto Reset should be performed after checking STA3=1(or STA2=1).

The flowchart for Data Auto Read/Write

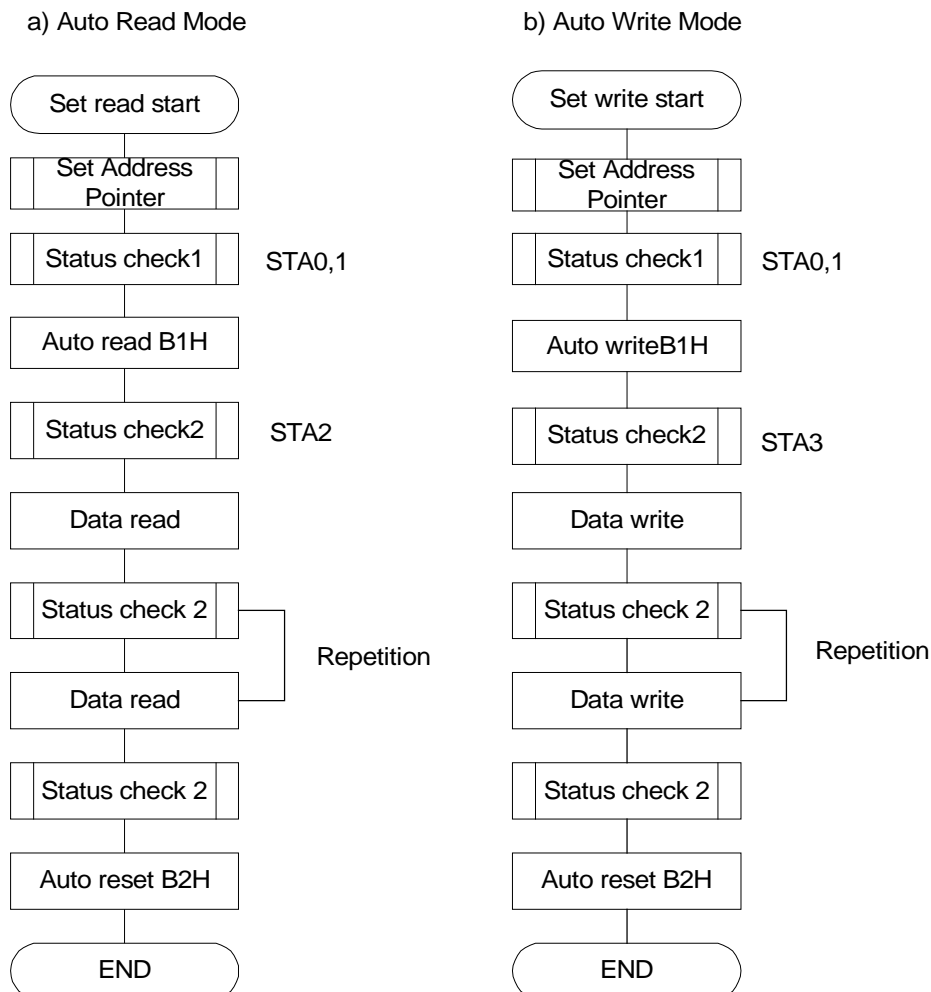

5.7 Data Read / Write

CODE	HEX.	FUNCTION	OPERAND
11000000	C0H	Data Write and Increment ADP	Data
11000001	C1H	Data Read and Increment ADP	--
11000010	C2H	Data Write and Decrement ADP	Data
11000011	C3H	Data Read and Decrement ADP	--
11000100	C4H	Data Write and Nonvariable ADP	Data
11000101	C5H	Data Read and Nonvariable ADP	--

This command is used for writing data from MPU to display RAM, and reading data from display RAM to MPU. Data Write/Read should be executed after setting address by Set Address Pointer command. The address pointer can be automatically incremented or decremented by using this command.

(Note) This command is necessary for each 1 byte data.

The flowchart for Data Write

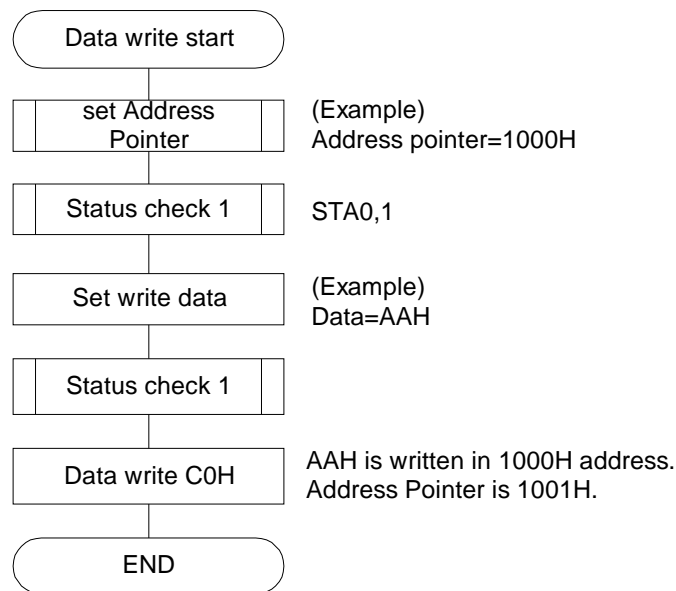

5.8 Screen Peek

CODE	HEX.	FUNCTION	OPERAND
11100000	E0H	Screen Peek	--

This command is used to transfer 1 byte displayed data to data stack, and this 1 byte data can be read from MPU by data read command. So, logical combination data of text and graphic display on LCD screen can be read by this command. Status (STA6) should be checked just after Screen Peek command. If the address determined by Set Address Pointer command is not in graphic RAM area, this command is ignored and status flag (STA6) is set.

The flowchart for Screen Peek command

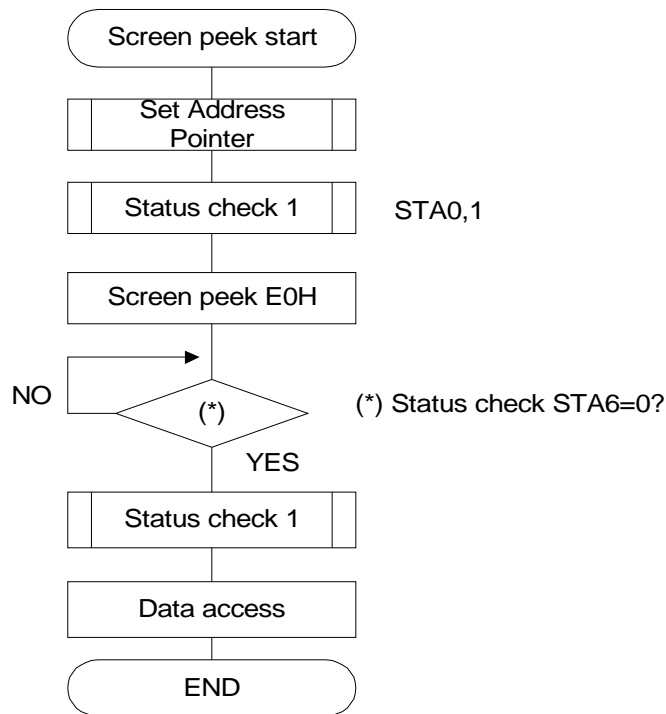

(Note) This command is available when hardware column number and software column number are the same. Software column number is related to Set Text Area and Set Graphic Area command. Set TA=28H, GA=28H when using this command.

5.9 Screen Copy

CODE	HEX.	FUNCTION	OPERAND
11101000	E8H	Screen Copy	--

This command copies 1 row data displayed on LCD screen to the graphic RAM area specified by Set Address Pointer command. Start point of 1 row data on the screen is determined by the Set Address Pointer command. If attribute function is being used, this command is not available. Status (STA6) should be checked just after this command. If the address determined by Set Address Pointer command is not located in graphic RAM area, this command is ignored and status flag (STA6) is set.

The flowchart for Screen Copy command

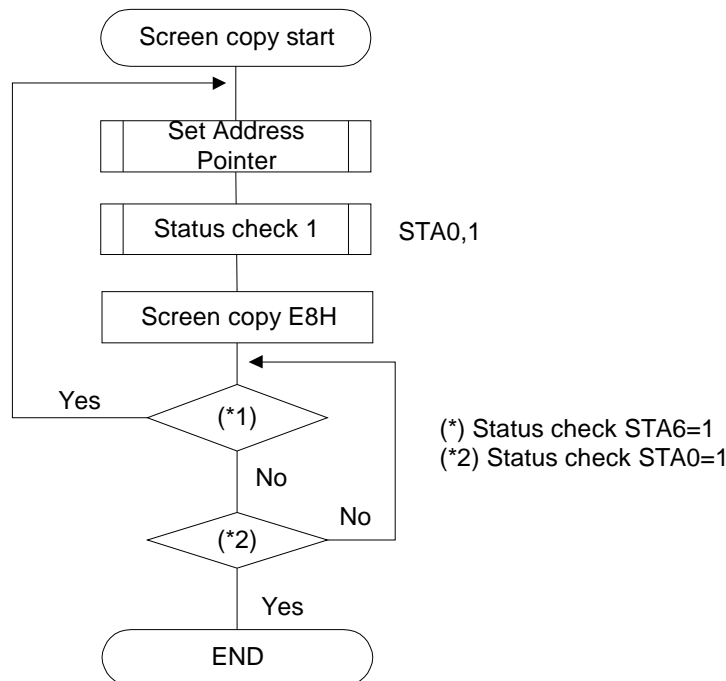

(Note) This command is available when hardware column number and software column number are the same. Software column number is related to Set Text Area and Set Graphic Area command. Set TA=28H, GA=28H when using this command.

5.10 Bit Set / Reset

CODE	FUNCTION	OPERAND
11110XXX	Bit Reset	--
11111XXX	Bit Set	--
1111X000	Bit 0 (LSB)	--
1111X001	Bit 1	--
1111X010	Bit 2	--
1111X011	Bit 3	--
1111X100	Bit 4	--
1111X101	Bit 5	--
1111X110	Bit 6	--
1111X111	Bit 7 (MSB)	--

X : Don't care

This command is used to set or reset a bit of the byte specified by the address pointer. Only one bit can be set / reset at a time.

The flowchart for Bit Set/Reset command

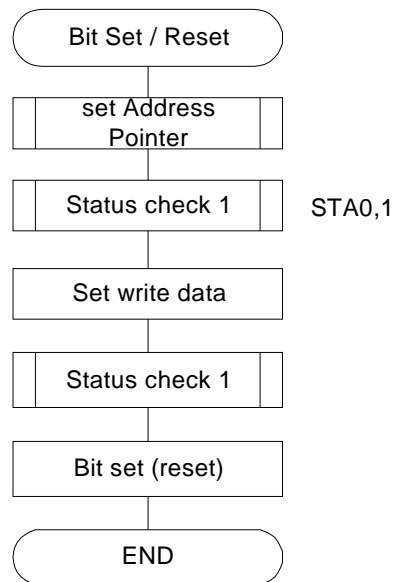

6. INITIALIZATION

Initialization of controller T6963C is required for “Mode set”, “Control Word Set” after power on. Following is an example of initialization procedure.

Command	C/D	D7	D6	D5	D4	D3	D2	D1	D0	Note
Power on	Power on									
Reset (use reset terminal)	/RST="L" (1 ms minimum after Vcc > 4.75V)									
Mode set	1	1	0	0	0	0	0	0	0	“OR” mode
Control word set	0	0	0	0	0	0	0	0	0	Graphic home address command
Graphic home address set (Graphic home address 0000H)	0	0	0	0	0	0	0	0	0	
Number of graphic area set (Graphic 30 x 8 dots)	1	0	1	0	0	0	0	1	0	Number of graphic area Command
	0	0	0	0	1	1	1	1	0	
	0	0	0	0	0	0	0	0	0	
Text home address set (Text home address 4000H)	1	0	1	0	0	0	0	0	0	Text home address Command
	0	0	0	0	0	0	0	0	0	
	0	0	1	0	0	0	0	0	0	
Number of text area set (Text 30 column)	1	0	1	0	0	0	0	0	1	Number of text area Command
	0	0	0	0	1	1	1	1	0	
	0	0	0	0	0	0	0	0	0	
(Initialization end) (Data write)										
Address pointer set (Address pointer 0000H)	0	0	0	0	0	0	0	0	0	Graphic address setting Command
	0	0	0	0	0	0	0	0	0	
	1	0	0	1	0	0	1	0	0	
Data write (Graphic)	0	0	1	0	1	0	1	0	1	Data Command
	1	1	1	1	0	0	0	0	0	
	0	1	0	1	0	1	0	1	0	Data Command
	1	1	1	1	0	0	0	0	0	
	--	--	--	--	--	--	--	--	--	
Address pointer set (Address pointer 4000H)	0	0	0	0	0	0	0	0	0	Text address setting Command
	0	0	1	0	0	0	0	0	0	
	1	0	0	1	0	0	1	0	0	
Data write (Text) (L)	0	0	0	1	0	1	1	1	1	Data Command
	1	1	1	0	0	0	0	0	0	
(A)	0	0	0	1	0	0	0	0	1	Data Command
	1	1	1	0	0	0	0	0	0	
	--	--	--	--	--	--	--	--	--	
Display Mode Set (Text/Graphic on)	1	1	0	0	1	1	1	0	0	

(Note) Status check should be inserted between all command and data.

7. CHARACTER GENERATOR

7.1 Character Generator ROM

Character generator ROM for 128 characters is built-in this module.

Character code map (ROM Code 0101)

MSB \ LSB	0	1	2	3	4	5	6	7	8	9	A	B	C	D	E	F
0	!	"	#	\$	%	&	'	()	*	+	,	-	.	/	
1	0	1	2	3	4	5	6	7	8	9	:	;	<	=	>	?
2	a	A	B	C	D	E	F	G	H	I	J	K	L	M	N	O
3	P	Q	R	S	T	U	V	W	X	Y	Z	[\]	^	_
4	`	a	b	c	d	e	f	g	h	i	j	k	l	m	n	o
5	p	q	r	s	t	u	v	w	x	y	z	{		}	~	
6	0	1	2	3	4	5	6	7	8	9	:	;	<	=	>	?
7	0	1	2	3	4	5	6	7	8	9	:	;	<	=	>	?

7.2 User Character Generator RAM

The character generator RAM is the built-in RAM which can be used as character generator after writing character pattern by program. Part of built-in RAM can be used as "User CG RAM" for 256 characters by selecting "CG RAM Mode", or for 128 characters by selecting "CG ROM Mode".

The upper 5 bits (NNNNN) in start address of User CG RAM is defined by "Registers Setting" command (Set Offset Register), and following 2048 bytes are defined as "User CG RAM" area when CG RAM Mode is selected; 1024 bytes (address: NNNNN1000000000 ~NNNNN1111111111) is defined as "User CG RAM" area when CG ROM Mode is selected.

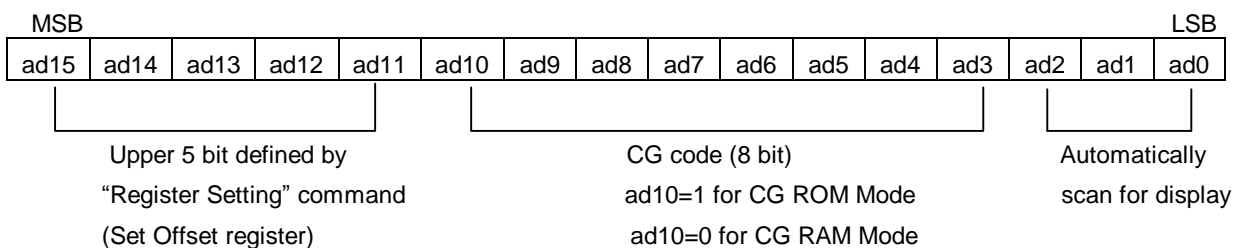

Relationship between User CG RAM Address and Offset Register

Offset register data	CG RAM Address (start to end)
00H	0000H to 07FFH
01H	0800H to 0FFFH
02H	1000H to 17FFH
--	--
0EH	7000H to 77FFH
0FH	7800H to 7FFFH

Character pattern of specified CG code can be written in the pointed address by “Register setting” command (Set Address Pointer). 8 bytes of data should be sent to following 8 bytes of address for 1 character.

Example:

Offset register	02H
Character code	80H
Character generator RAM start address	0001 0100 0000 0000
	1 4 0 0 H

(address)	(data)
1400H	00H
1401H	1FH
1402H	04H
1403H	04H
1404H	04H
1405H	04H
1406H	04H
1407H	00H

Character pattern can be displayed by sending CG code with “Data Write” command. But “Set Display Mode” for text display should be selected before using CG. In case that “CG ROM Mode” is selected, character pattern is selected from built-in CG ROM when MSB=0 (00H - 7FH), and from User CG RAM when MSB=1 (80H-FFH). In case that “CG RM Mode” is selected, all character patterns are selected from User CG RAM (00H-FFH). (Note) It must be careful so that User CG RAM area should not be rewritten by display data, etc.

8. ELECTRO—OPTICAL CHARACTERISTICS (Ta=25°C)

Item	Symbol	Condition	Min.	Typ.	Max.	Unit	Note
View Angle	$\Phi 2-\Phi 1$	$K \geq 2, \theta = 0^\circ$	--	60	--	Deg	Note1, Note2
Contrast	K	$\Phi = 0^\circ, \theta = 0^\circ$	3	--	--	--	Note3
Response Time	tr (rise)	$\Phi = 0^\circ, \theta = 0^\circ$	--	250	--	ms	Note3
	tf (fall)	$\Phi = 0^\circ, \theta = 0^\circ$	--	250	--	ms	

Note1: Definition of Viewing Angle θ, Φ

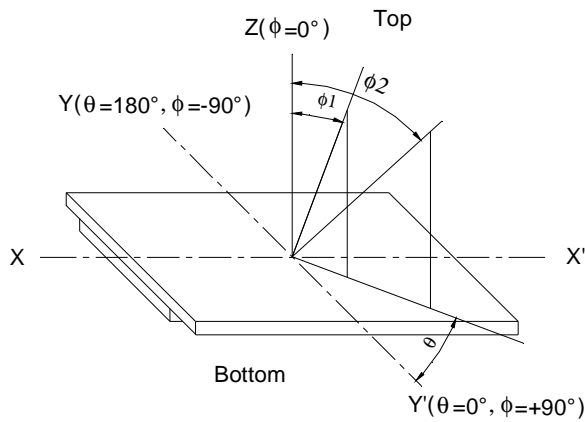

Note2: Definition of viewing Angle Range: $\Phi 1, \Phi 2$

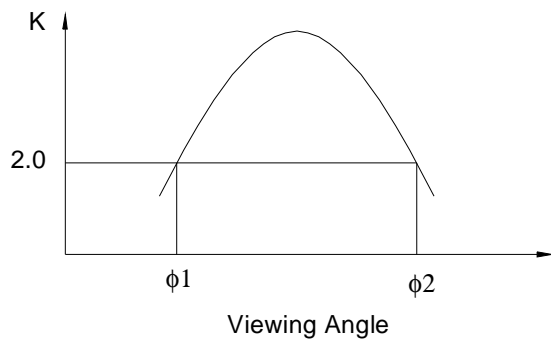

Note3: Definition of Contrast

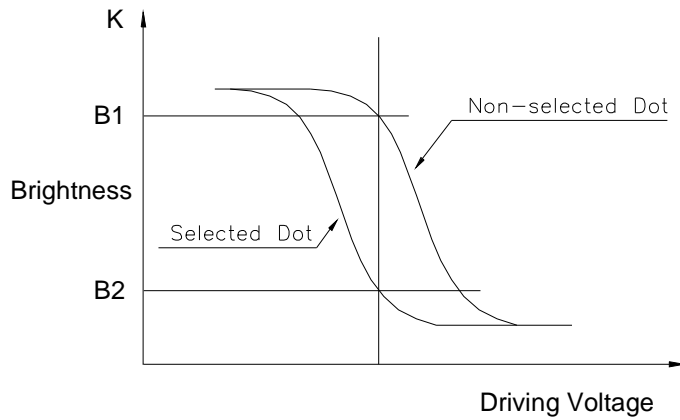

$$\text{Contrast} = \frac{\text{Brightness of non-selected dot (B1)}}{\text{Brightness of selected dot (B2)}}$$

Note4: Definition of Response Time

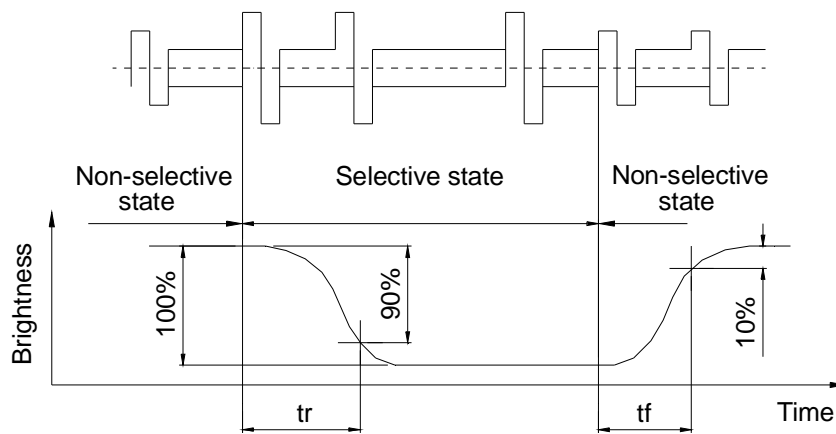

9. DIMENSIONAL OUTLINE

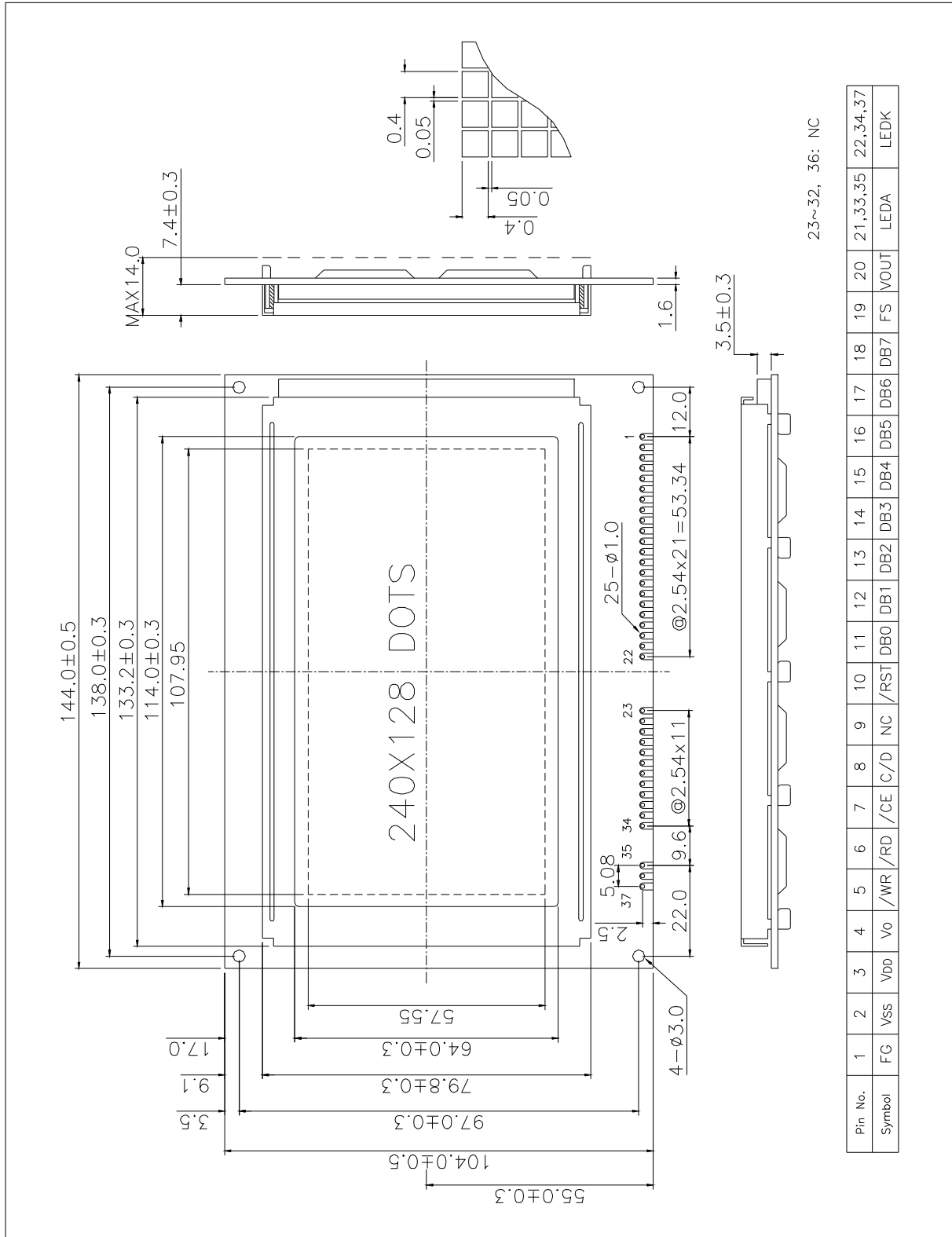

10. LCD MODULE NUMBERING SYSTEM

L G 240 128 1 — B M D W H 6 V — XXX
 (1) (2) (3) (4) (5) (6) (7) (8) (9) (10) (11) (12) (13)

(1) Brand

(2) Module type

C - Character module

G - Graphic module

(3) Display format

Character module : Number of characters per line, two digits XX

Graphic module : Number of columns, two or three digits XX or XXX

(4) Display format

Character module : Number of lines, one digit X

Graphic module : Number of rows, two or three digits XX or XXX

(5) Development number : One digit X (**1~9, A~Z**)

(6) LCD mode

T - TN Positive, Gray

N - TN Negative, Blue

S - STN Positive, Yellow-green

G - STN Positive, Gray

B - STN Negative, Blue

F - FSTN Positive, White

K - FSTN Negative, Black

L - FSTN Negative, Blue

(7) Polarizer mode

R - Reflective

F - Transflective

M - Transmissive

(8) Backlight type

N - Without backlight

L - Array LED

D - Edge light LED

E - EL

C - CCFL

(9) Backlight color

Y - Yellow-green

B - Blue

W - White

G - Green

A - Amber

R - Red

M - Multi color

Nil - Without backlight

(10) Operating temperature range

S - Standard temperature (0 ~ +50 °C)

H - Extended Temperature (-20 ~ +70 °C)

(11) Viewing direction

3 - 3:00

6 - 6:00

9 - 9:00

U - 12:00

(12) DC-DC Converter

N or Nil - Without DC-DC converter

V - Built in DC-DC converter

(13) Version code

0~ZZZ - Version code

11. PRECAUTIONS FOR USE OF LCD MODULE

11.1 Handling Precautions

- 1) The display panel is made of glass. Do not subject it to a mechanical shock by dropping it from a high place, etc.
- 2) If the display panel is damaged and the liquid crystal substance inside it leaks out, be sure not to get any in your mouth. If the substance comes into contact with your skin or clothes, promptly wash it off using soap and water.
- 3) Do not apply excessive force on the surface of display or the adjoining areas of LCD module since this may cause the color tone to vary.
- 4) The polarizer covering the display surface of the LCD module is soft and easily scratched. Handle this polarizer carefully.
- 5) If the display surface of LCD module becomes contaminated, blow on the surface and gently wipe it with a soft dry cloth. If it is heavily contaminated, moisten cloth with one of the following solvents.

- Isopropyl alcohol
- Ethyl alcohol

Solvents other than those mentioned above may damage the polarizer.

Especially, do not use the following:

- Water
 - Ketone
 - Aromatic Solvents
- 6) When mounting the LCD module make sure that it is free of twisting, warping, and distortion. Distortion has great influence upon display quality. Also keep the stiffness enough regarding the outer case.
 - 7) Be sure to avoid any solvent such as flux for soldering never stick to Heat-Seal. Such solvent on Heat-Seal may cause connection problem of heat-Seal and TAB.
 - 8) Do not forcibly pull or bend the TAB I/O terminals.
 - 9) Do not attempt to disassemble or process the LCD module.
 - 10) NC terminal should be open. Do not connect anything.
 - 11) If the logic circuit power is off, do not apply the input signals.
 - 12) To prevent destruction of the elements by static electricity, be careful to maintain an optimum work environment.
 - Be sure to ground the body when handling the LCD module.
 - Tools required for assembly, such as soldering irons, must be properly grounded.
 - To reduce the amount of static electricity generated, do not conduct assembly and other work under dry conditions.
 - The LCD module is coated with a film to protect the display surface. Exercise care when peeling off this protective film since static electricity may be generated.

11.2 Storage Precautions

- 1) When storing the LCD module, avoid exposure to direct sunlight or to the light of fluorescent lamps and high temperature/high humidity. Whenever possible, the LCD module should be stored in the same conditions in which they were shipped from our company.
- 2) Exercise care to minimize corrosion of the electrodes. Corrosion of the electrodes is accelerated by water droplets or a current flow in a high humidity environment.

11.3 Design Precautions

- 1) The absolute maximum ratings represent the rated value beyond which LCD module can not exceed. When the LCD modules are used in excess of this rated value, their operating characteristics may be adversely affected.
- 2) To prevent the occurrence of erroneous operation caused by noise, attention must be paid to satisfy VIL, VIH specification values, including taking the precaution of using signal cables that are short.
- 3) The liquid crystal display exhibits temperature dependency characteristics. Since recognition of the display becomes difficult when the LCD is used outside its designated operating temperature range, be sure to use the LCD within this range. Also, keep in mind that the LCD driving voltage levels necessary for clear displays will vary according to temperature.
- 4) Sufficiently notice the mutual noise interference occurred by peripheral devices.
- 5) To cope with EMI, take measures basically on outputting side.
- 6) If DC is impressed on the liquid crystal display panel, display definition is rapidly deteriorated by the electrochemical reaction that occurs inside the liquid crystal display panel. To eliminate the opportunity of DC impressing, be sure to maintain the AC characteristics of the input signals sent to the LCD Module.

11.4 Others

- 1) Liquid crystals solidify under low temperatures (below the storage temperature range) leading to defective orientation or the generation of air bubbles (black or white).
Air bubbles may also be generated if the LCD module is subjected to a strong shock at a low temperature.
- 2) If the LCD modules have been operating for a long time showing the same display patterns, the display patterns may remain on the screen as ghost images and a slight contrast irregularity may also appear. A normal operating status can be regained by suspending use for some time. It should be noted that this phenomenon does not adversely affect performance reliability.
- 3) To minimize the performance degradation of the LCD modules resulting from destruction caused by static electricity, etc., exercise care to avoid touching the following sections when handling the module:
 - Terminal electrode sections.
 - Part of pattern wiring on TAB, etc.