

# GPDC0799

## RECTIFIER DIODE

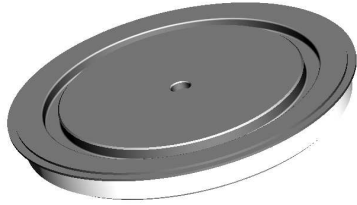

Low profile ceramic package  
Spot welding applications  
Electroplating applications

**VOLTAGE UP TO** 200 V  
**AVERAGE CURRENT** 7990 A  
**SURGE CURRENT** 55 kA

### BLOCKING CHARACTERISTICS

Characteristic		Conditions	Value
V <sub>RRM</sub>	Repetitive peak reverse voltage		200 V
V <sub>RSM</sub>	Non-repetitive peak reverse voltage		300 V
I <sub>RRM</sub>	Repetitive peak reverse current, max.	V <sub>RRM</sub> , single phase, half wave, T <sub>j</sub> = T <sub>jmax</sub>	50 mA

### FORWARD CHARACTERISTICS

I <sub>F(AV)</sub>	Average forward current	Sine wave, 180° conduction, T <sub>c</sub> = 70°C	7990 A
I <sub>F(RMS)</sub>	R.M.S. forward current	Sine wave, 180° conduction, T <sub>c</sub> = 70°C	12551 A
I <sub>FSM</sub>	Surge forward current	Non rep. half sine wave, 50 Hz, V <sub>R</sub> = 0 V, T <sub>j</sub> = T <sub>jmax</sub>	55 kA
I <sup>2</sup> t	I <sup>2</sup> t for fusing coordination		15125 kA <sup>2</sup> s
V <sub>F(TO)</sub>	Threshold voltage	T <sub>j</sub> = T <sub>jmax</sub>	0,74 V
r <sub>F</sub>	Forward slope resistance	T <sub>j</sub> = T <sub>jmax</sub>	0,026 mΩ
V <sub>FM</sub>	Peak forward voltage, max	Forward current I <sub>F</sub> = 5000 A, T <sub>j</sub> = 25°C	1,05 V

### SWITCHING CHARACTERISTICS

Q <sub>rr</sub>	Reverse recovery charge, typ	T <sub>j</sub> = T <sub>jmax</sub> , I <sub>F</sub> = 1000 A, di/dt = -30 A/μs	500 μC
I <sub>rr</sub>	Reverse recovery current	V <sub>R</sub> = 100 V	A
t <sub>rr</sub>	Reverse recovery time		μs
V <sub>FP</sub>	Forward recovery voltage	T <sub>j</sub> = T <sub>jmax</sub> , di/dt = A/μs	V

### THERMAL AND MECHANICAL CHARACTERISTICS

R <sub>th(j-c)</sub>	Thermal resistance (junction to case)	Double side cooled	0,010 °C/W
R <sub>th(c-h)</sub>	Thermal resistance (case to heatsink)	Double side cooled	0,005 °C/W
T <sub>jmax</sub>	Max operating junction temperature		170 °C
T <sub>stg</sub>	Storage temperature		-40 / 170 °C
F	Clamping force ± 10%		22 kN
	Mass		150 g

Current rating - sine wave

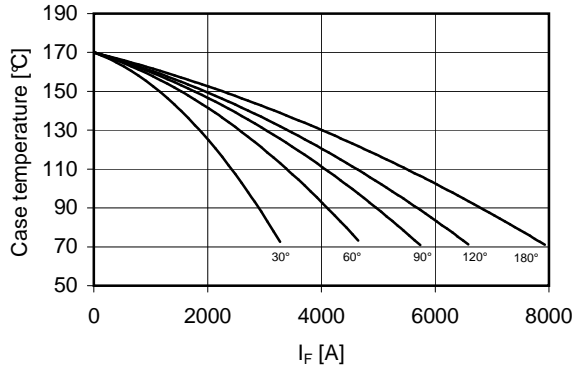

Power loss - sine wave

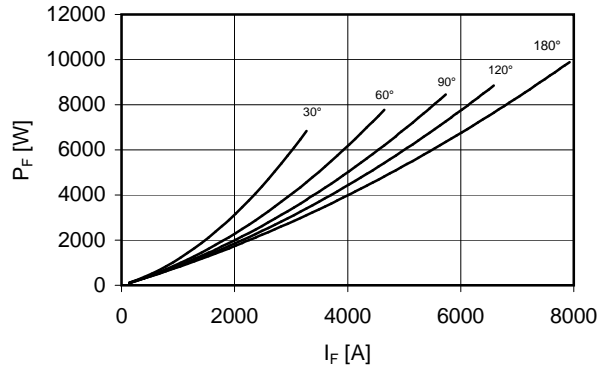

Maximum surge current  
d.s. cooled

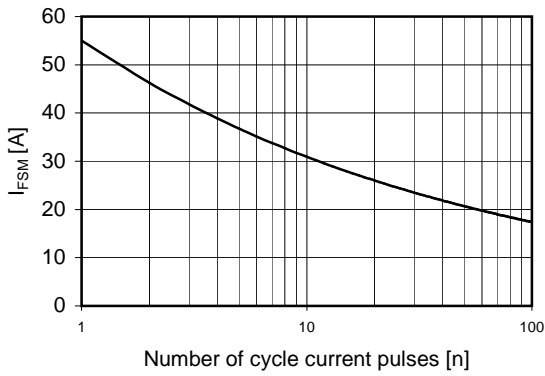

Forward voltage drop

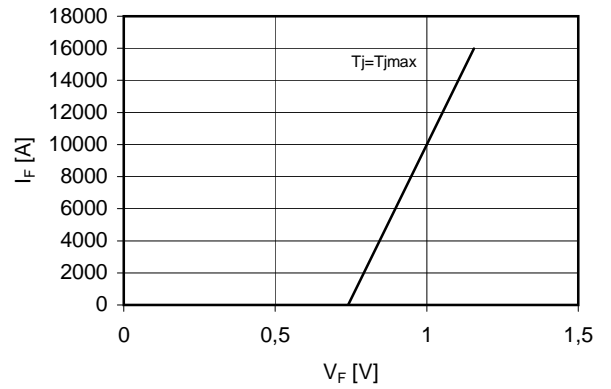

Thermal Impedance (j-c)

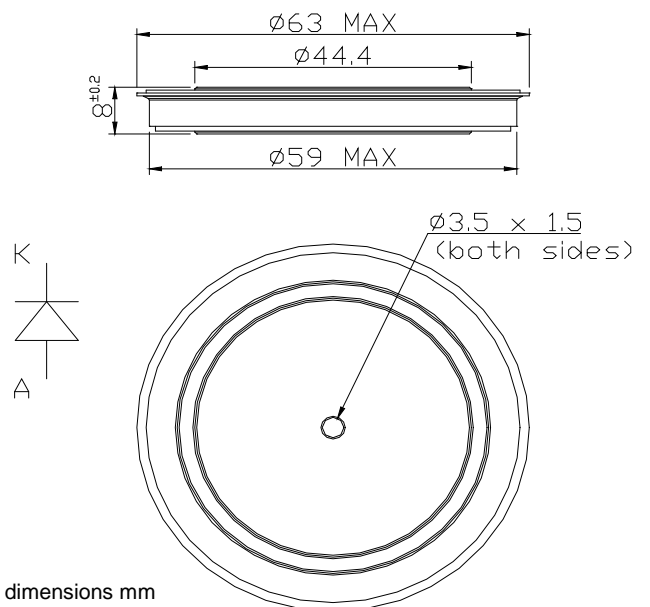
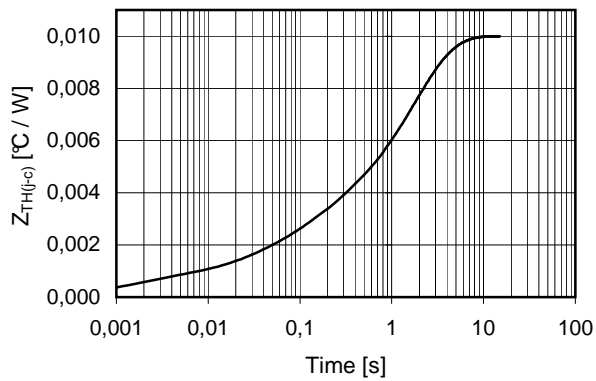

dimensions mm

In the interest of product improvement Green Power Solutions reserves the right to change any specification given in this data sheet without notice.