

**AUTOMOTIVE MOSFET**

**IRFR3505**  
**IRFU3505**  
 HEXFET® Power MOSFET

**Features**

- Advanced Process Technology
- Ultra Low On-Resistance
- 175°C Operating Temperature
- Fast Switching
- Repetitive Avalanche Allowed up to T<sub>Jmax</sub>

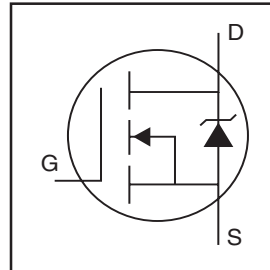

$V_{DSS} = 55V$
$R_{DS(on)} = 0.013\Omega$
$I_D = 30A$

**Description**

Specifically designed for Automotive applications, this HEXFET® Power MOSFET utilizes the latest processing techniques to achieve extremely low on-resistance per silicon area. Additional features of this product are a 175°C junction operating temperature, fast switching speed and improved repetitive avalanche rating. These features combine to make this design an extremely efficient and reliable device for use in Automotive applications and a wide variety of other applications.

The D-Pak is designed for surface mounting using vapor phase, infrared, or wave soldering techniques. The straight lead version (IRFU series) is for through-hole mounting applications. Power dissipation levels up to 1.5 watts are possible in typical surface mount applications.

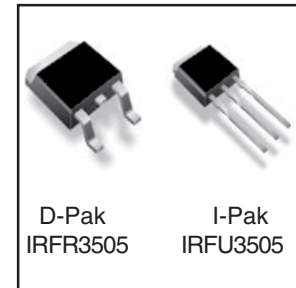

**Absolute Maximum Ratings**

	Parameter	Max.	Units
$I_D @ T_C = 25^\circ C$	Continuous Drain Current, $V_{GS} @ 10V$ (Silicon limited)	71	A
$I_D @ T_C = 100^\circ C$	Continuous Drain Current, $V_{GS} @ 10V$ (See Fig.9)	49	
$I_D @ T_C = 25^\circ C$	Continuous Drain Current, $V_{GS} @ 10V$ (Package limited)	30	
$I_{DM}$	Pulsed Drain Current ①	280	
$P_D @ T_C = 25^\circ C$	Power Dissipation	140	W
	Linear Derating Factor	0.92	W/°C
$V_{GS}$	Gate-to-Source Voltage	± 20	V
$E_{AS}$	Single Pulse Avalanche Energy②	210	mJ
$E_{AS} (tested)$	Single Pulse Avalanche Energy Tested Value②	410	
$I_{AR}$	Avalanche Current①	See Fig.12a, 12b, 15, 16	A
$E_{AR}$	Repetitive Avalanche Energy⑥		mJ
dv/dt	Peak Diode Recovery dv/dt ③	4.0	V/ns
$T_J$	Operating Junction and	-55 to + 175	°C
$T_{STG}$	Storage Temperature Range		
	Soldering Temperature, for 10 seconds	300 (1.6mm from case )	

**Thermal Resistance**

	Parameter	Typ.	Max.	Units
$R_{\theta JC}$	Junction-to-Case	—	1.09	°C/W
$R_{\theta JA}$	Junction-to-Ambient (PCB mount)④	—	40	
$R_{\theta JA}$	Junction-to-Ambient	—	110	



**KERSEMI**

# IRFR/U3505

## Electrical Characteristics @ T<sub>J</sub> = 25°C (unless otherwise specified)

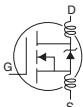
	Parameter	Min.	Typ.	Max.	Units	Conditions
V <sub>(BR)DSS</sub>	Drain-to-Source Breakdown Voltage	55	—	—	V	V <sub>GS</sub> = 0V, I <sub>D</sub> = 250μA
ΔV <sub>(BR)DSS/ΔT<sub>J</sub></sub>	Breakdown Voltage Temp. Coefficient	—	0.057	—	V/°C	Reference to 25°C, I <sub>D</sub> = 1mA
R <sub>DS(on)</sub>	Static Drain-to-Source On-Resistance	—	0.011	0.013	Ω	V <sub>GS</sub> = 10V, I <sub>D</sub> = 30A ④
V <sub>GS(th)</sub>	Gate Threshold Voltage	2.0	—	4.0	V	V <sub>DS</sub> = 10V, I <sub>D</sub> = 250μA
g <sub>fs</sub>	Forward Transconductance	41	—	—	S	V <sub>DS</sub> = 25V, I <sub>D</sub> = 30A
I <sub>DSS</sub>	Drain-to-Source Leakage Current	—	—	20	μA	V <sub>DS</sub> = 55V, V <sub>GS</sub> = 0V
		—	—	250		V <sub>DS</sub> = 55V, V <sub>GS</sub> = 0V, T <sub>J</sub> = 125°C
I <sub>GSS</sub>	Gate-to-Source Forward Leakage	—	—	200	nA	V <sub>GS</sub> = 20V
	Gate-to-Source Reverse Leakage	—	—	-200		V <sub>GS</sub> = -20V
Q <sub>g</sub>	Total Gate Charge	—	62	93	nC	I <sub>D</sub> = 30A
Q <sub>gs</sub>	Gate-to-Source Charge	—	17	26		V <sub>DS</sub> = 44V
Q <sub>gd</sub>	Gate-to-Drain ("Miller") Charge	—	22	33		V <sub>GS</sub> = 10V ④
t <sub>d(on)</sub>	Turn-On Delay Time	—	13	—	ns	V <sub>DD</sub> = 28V
t <sub>r</sub>	Rise Time	—	74	—		I <sub>D</sub> = 30A
t <sub>d(off)</sub>	Turn-Off Delay Time	—	43	—		R <sub>G</sub> = 6.8Ω
t <sub>f</sub>	Fall Time	—	54	—		V <sub>GS</sub> = 10V ④
L <sub>D</sub>	Internal Drain Inductance	—	4.5	—	nH	Between lead, 6mm (0.25in.) from package and center of die contact
L <sub>S</sub>	Internal Source Inductance	—	7.5	—		
C <sub>iss</sub>	Input Capacitance	—	2030	—	pF	V <sub>GS</sub> = 0V
C <sub>oss</sub>	Output Capacitance	—	470	—		V <sub>DS</sub> = 25V
C <sub>rss</sub>	Reverse Transfer Capacitance	—	91	—		f = 1.0MHz, See Fig. 5
C <sub>oss</sub>	Output Capacitance	—	2600	—		V <sub>GS</sub> = 0V, V <sub>DS</sub> = 1.0V, f = 1.0MHz
C <sub>oss</sub>	Output Capacitance	—	330	—		V <sub>GS</sub> = 0V, V <sub>DS</sub> = 44V, f = 1.0MHz
C <sub>oss eff.</sub>	Effective Output Capacitance ⑤	—	630	—		V <sub>GS</sub> = 0V, V <sub>DS</sub> = 0V to 44V

## Source-Drain Ratings and Characteristics

	Parameter	Min.	Typ.	Max.	Units	Conditions
I <sub>S</sub>	Continuous Source Current (Body Diode)	—	—	71	A	MOSFET symbol showing the integral reverse p-n junction diode.
I <sub>SM</sub>	Pulsed Source Current (Body Diode) ①	—	—	280		
V <sub>SD</sub>	Diode Forward Voltage	—	—	1.3	V	T <sub>J</sub> = 25°C, I <sub>S</sub> = 30A, V <sub>GS</sub> = 0V ④
t <sub>rr</sub>	Reverse Recovery Time	—	70	105	ns	T <sub>J</sub> = 25°C, I <sub>F</sub> = 30A, V <sub>DD</sub> = 28V
Q <sub>rr</sub>	Reverse Recovery Charge	—	180	270	nC	di/dt = 100A/μs ④
t <sub>on</sub>	Forward Turn-On Time	Intrinsic turn-on time is negligible (turn-on is dominated by L <sub>S</sub> +L <sub>D</sub> )				



KERSEMI

# IRFR/U3505

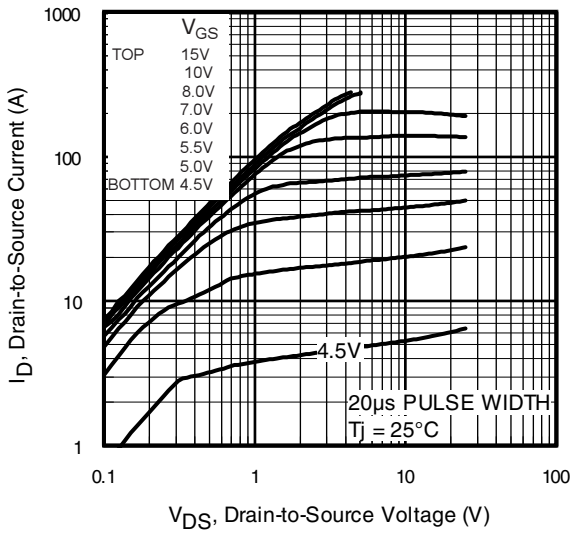

Fig 1. Typical Output Characteristics

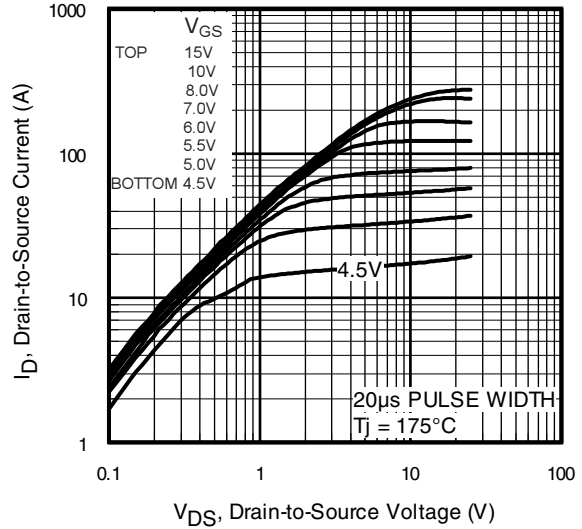

Fig 2. Typical Output Characteristics

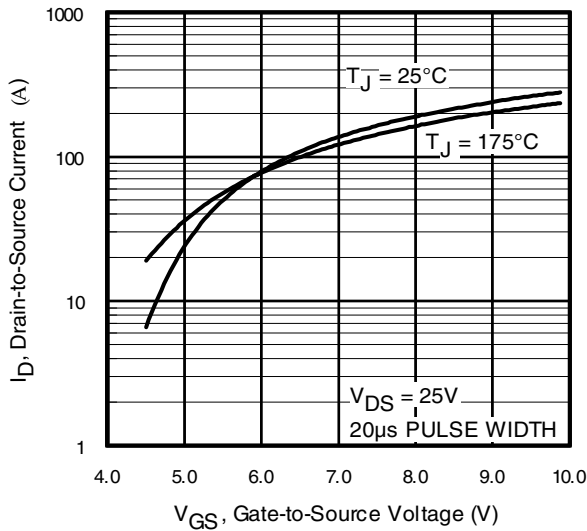

Fig 3. Typical Transfer Characteristics

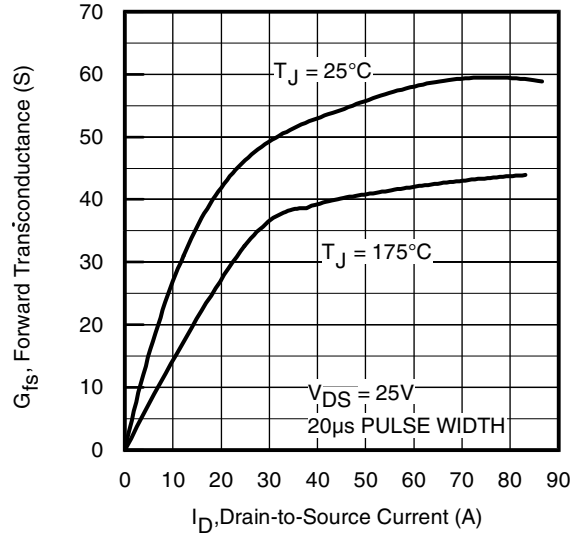
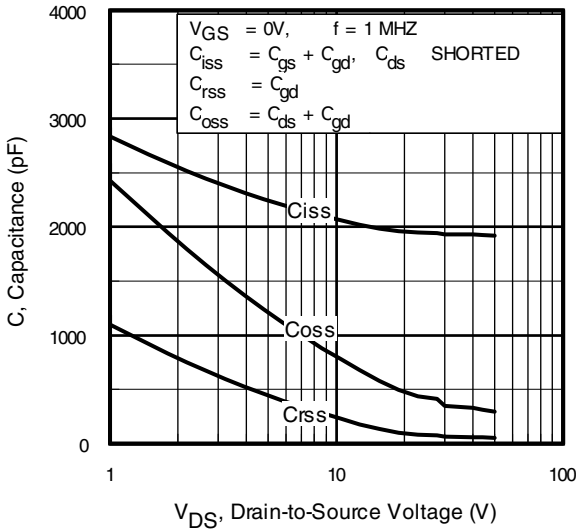
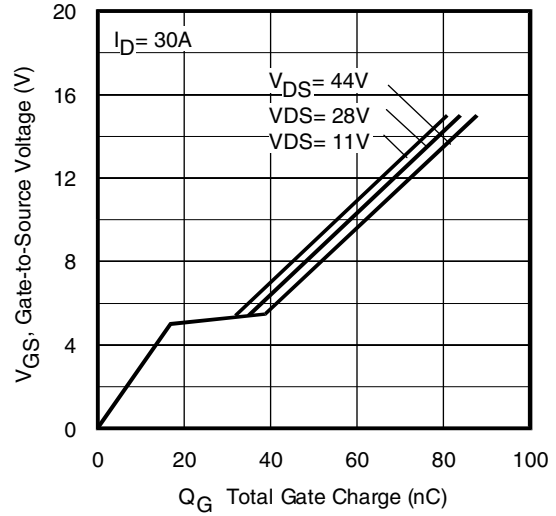

Fig 4. Typical Forward Transconductance Vs. Drain Current

# IRFR/U3505



**Fig 5.** Typical Capacitance Vs. Drain-to-Source Voltage



**Fig 6.** Typical Gate Charge Vs. Gate-to-Source Voltage

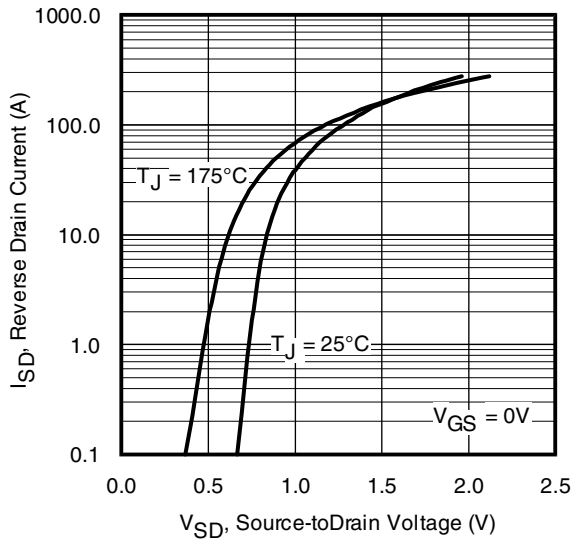

**Fig 7.** Typical Source-Drain Diode Forward Voltage

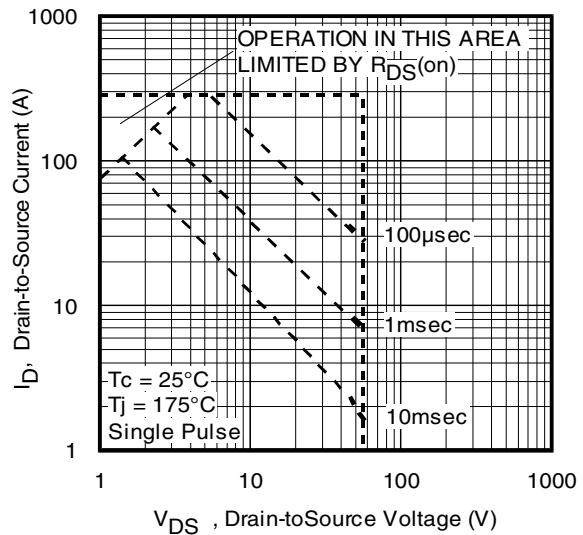

**Fig 8.** Maximum Safe Operating Area



KERSEMI

# IRFR/U3505

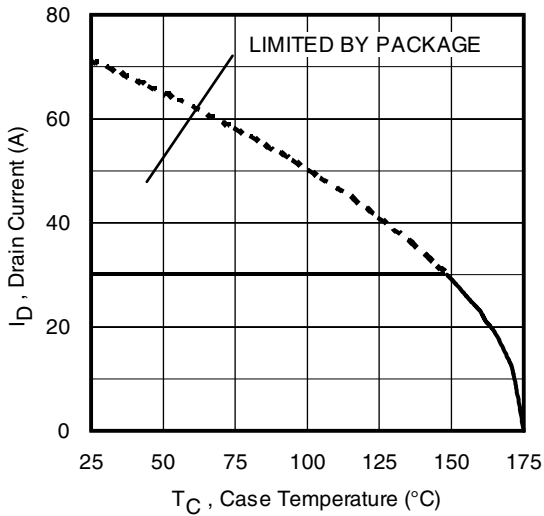

Fig 9. Maximum Drain Current Vs. Case Temperature

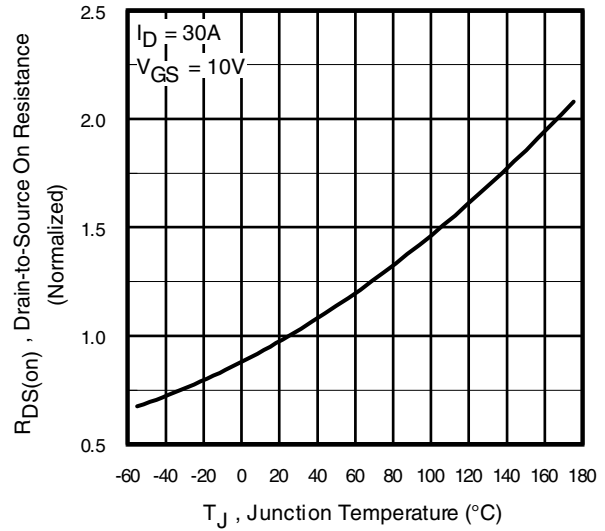

Fig 10. Normalized On-Resistance Vs. Temperature

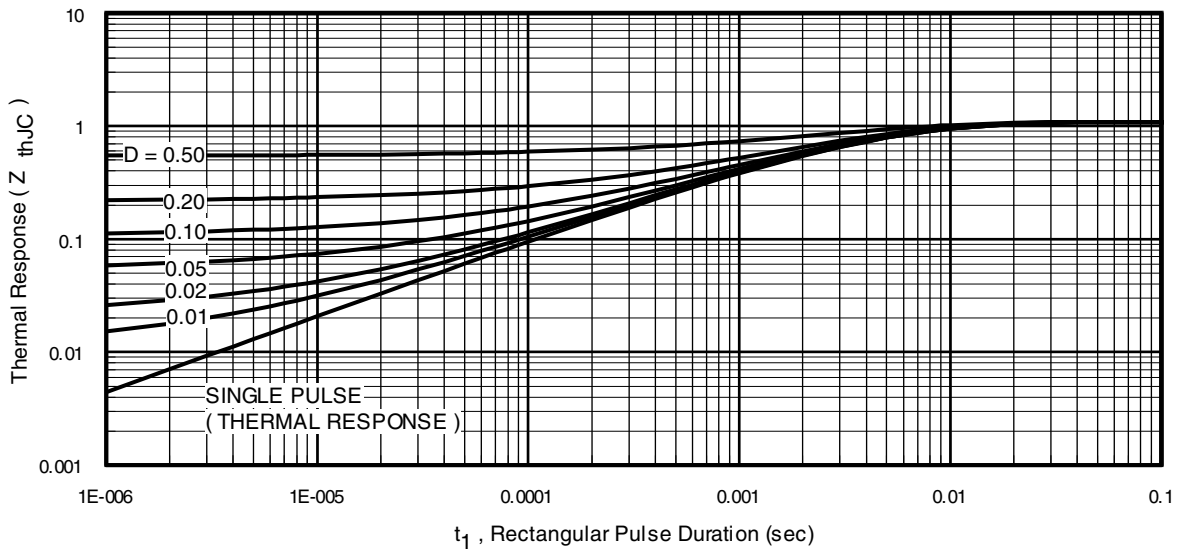
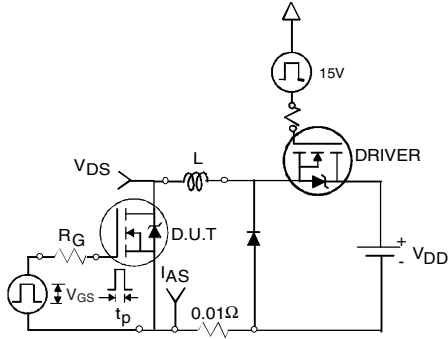

Fig 11. Maximum Effective Transient Thermal Impedance, Junction-to-Case



**KERSEMI**

# IRFR/U3505



**Fig 12a.** Unclamped Inductive Test Circuit

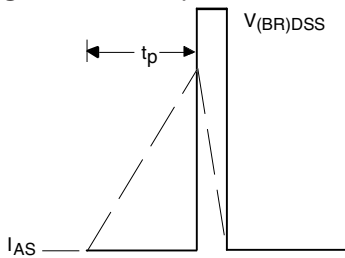

**Fig 12b.** Unclamped Inductive Waveforms

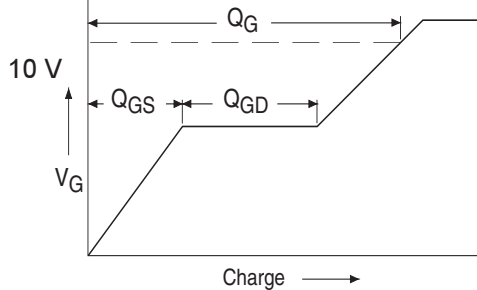

**Fig 13a.** Basic Gate Charge Waveform

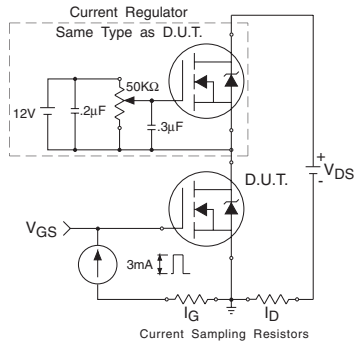

**Fig 13b.** Gate Charge Test Circuit

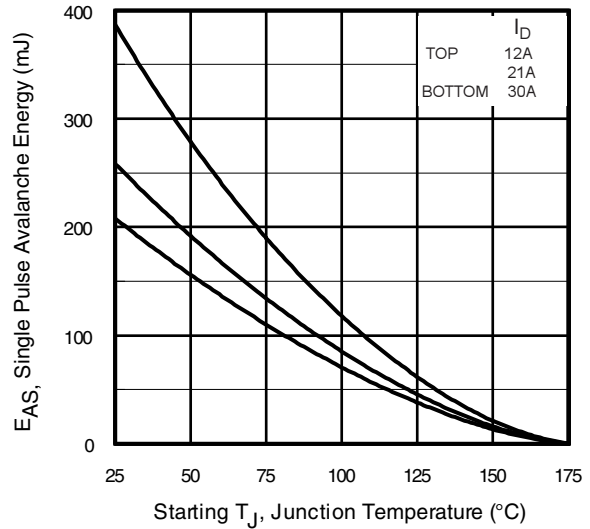

**Fig 12c.** Maximum Avalanche Energy Vs. Drain Current

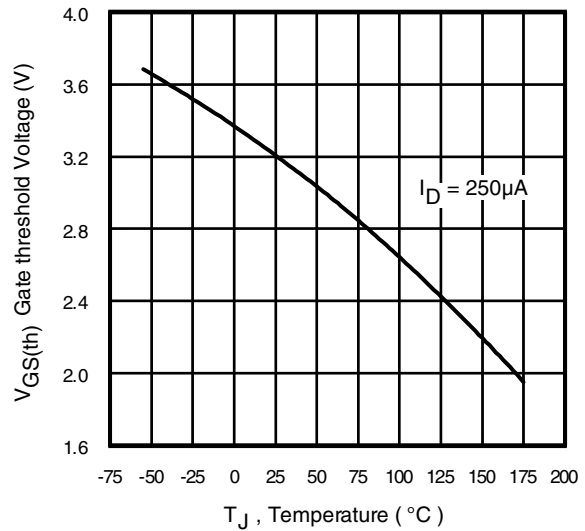
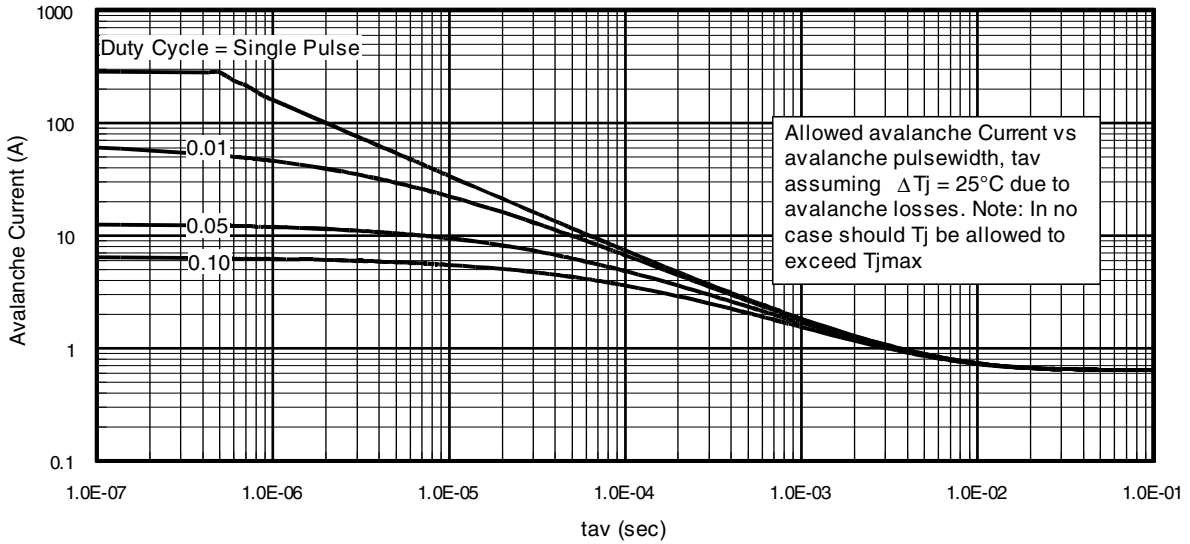

**Fig 14.** Threshold Voltage Vs. Temperature



KERSEMI

# IRFR/U3505



**Fig 15.** Typical Avalanche Current Vs.Pulsewidth

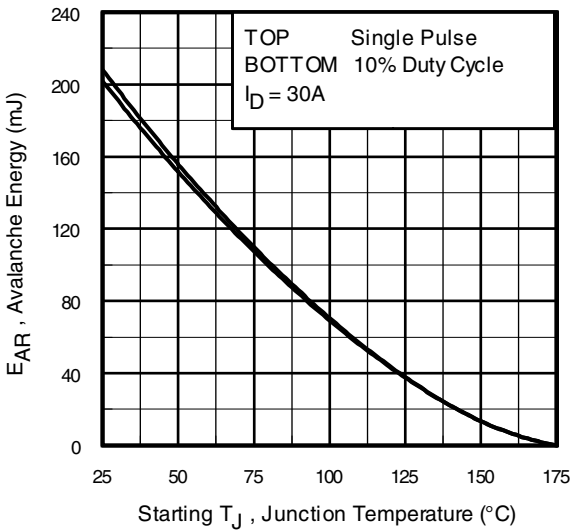

**Fig 16.** Maximum Avalanche Energy Vs. Temperature

**Notes on Repetitive Avalanche Curves , Figures 15, 16:**  
**(For further info, see AN-1005 at www.irf.com)**

1. Avalanche failures assumption:  
Purely a thermal phenomenon and failure occurs at a temperature far in excess of  $T_{jmax}$ . This is validated for every part type.
2. Safe operation in Avalanche is allowed as long as  $T_{jmax}$  is not exceeded.
3. Equation below based on circuit and waveforms shown in Figures 12a, 12b.
4.  $P_{D(ave)}$  = Average power dissipation per single avalanche pulse.
5. BV = Rated breakdown voltage (1.3 factor accounts for voltage increase during avalanche).
6.  $I_{av}$  = Allowable avalanche current.
7.  $\Delta T$  = Allowable rise in junction temperature, not to exceed  $T_{jmax}$  (assumed as 25°C in Figure 15, 16).  
 $t_{av}$  = Average time in avalanche.  
 $D$  = Duty cycle in avalanche =  $t_{av} \cdot f$   
 $Z_{thJC}(D, t_{av})$  = Transient thermal resistance, see figure 11)

$$P_{D(ave)} = 1/2 ( 1.3 \cdot BV \cdot I_{av} ) = \Delta T / Z_{thJC}$$

$$I_{av} = 2\Delta T / [1.3 \cdot BV \cdot Z_{th}]$$

$$E_{AS(AR)} = P_{D(ave)} \cdot t_{av}$$



KERSEMI

# IRFR/U3505

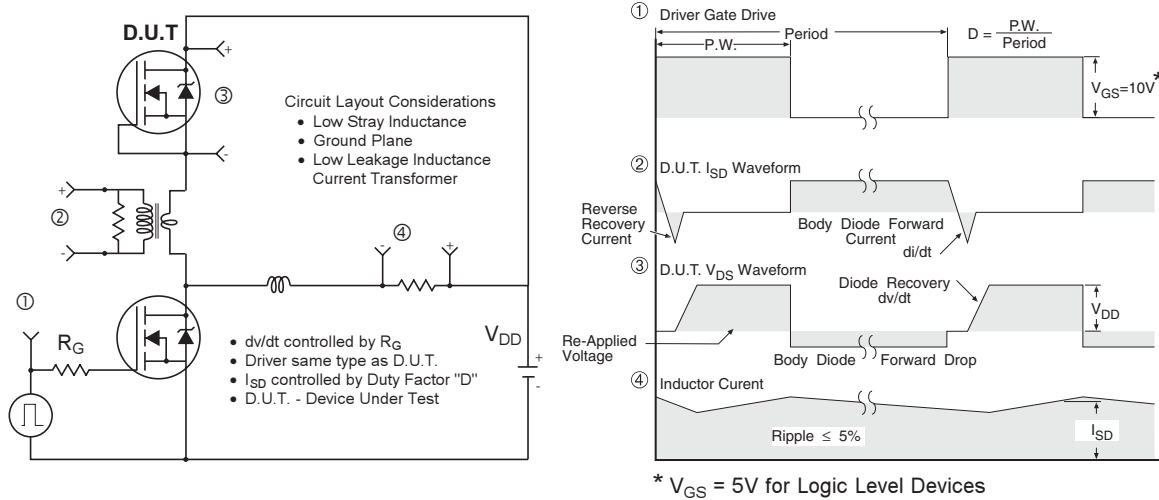

**Fig 17. Peak Diode Recovery  $dv/dt$  Test Circuit for N-Channel HEXFET® Power MOSFETs**

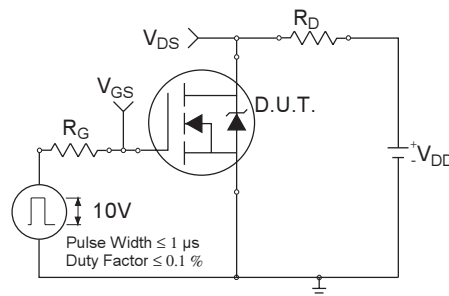

**Fig 18a. Switching Time Test Circuit**

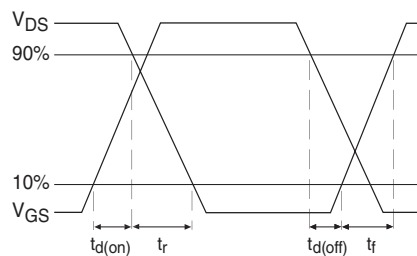
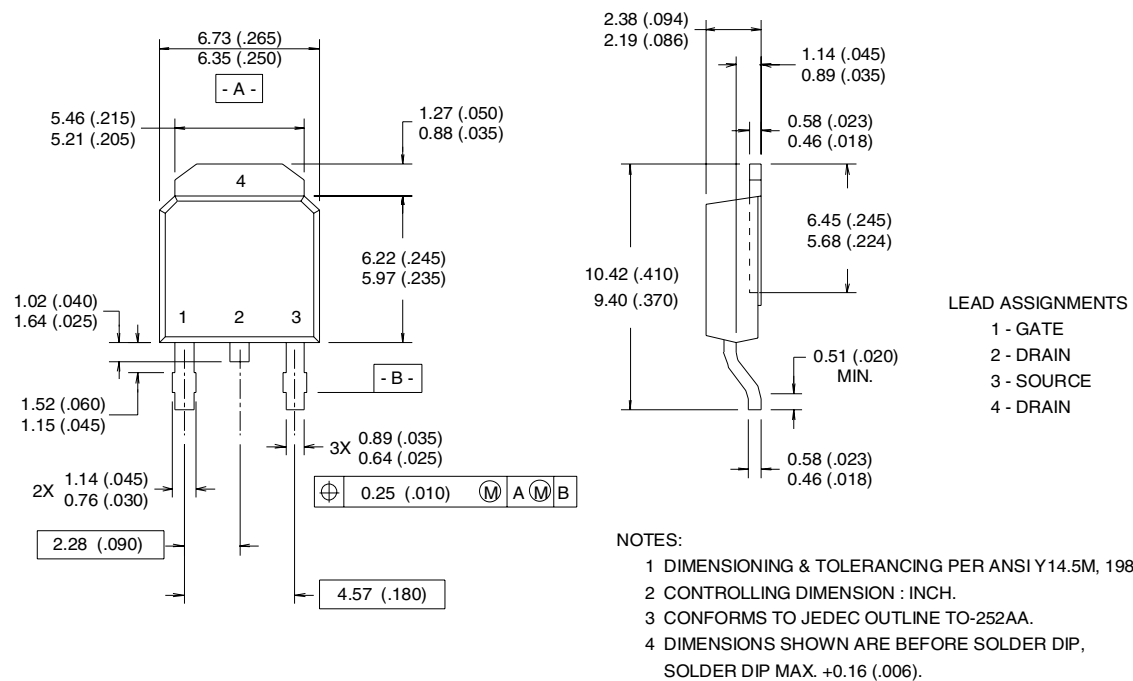

**Fig 18b. Switching Time Waveforms**



## D-Pak (TO-252AA) Package Outline

Dimensions are shown in millimeters (inches)



## D-Pak (TO-252AA) Part Marking Information

EXAMPLE: THIS IS AN IRFR120  
 LOT CODE 1789  
 ASSEMBLED ON WW 19, 1997  
 IN THE ASSEMBLY LINE "C"

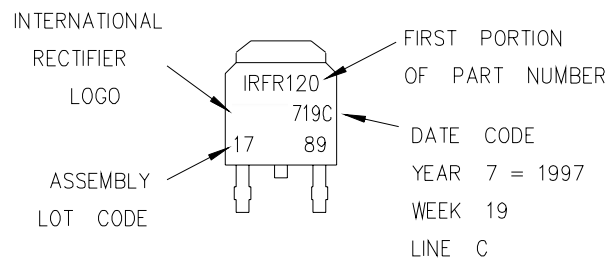

# IRFR/U3505

## I-Pak (TO-251AA) Package Outline

Dimensions are shown in millimeters (inches)

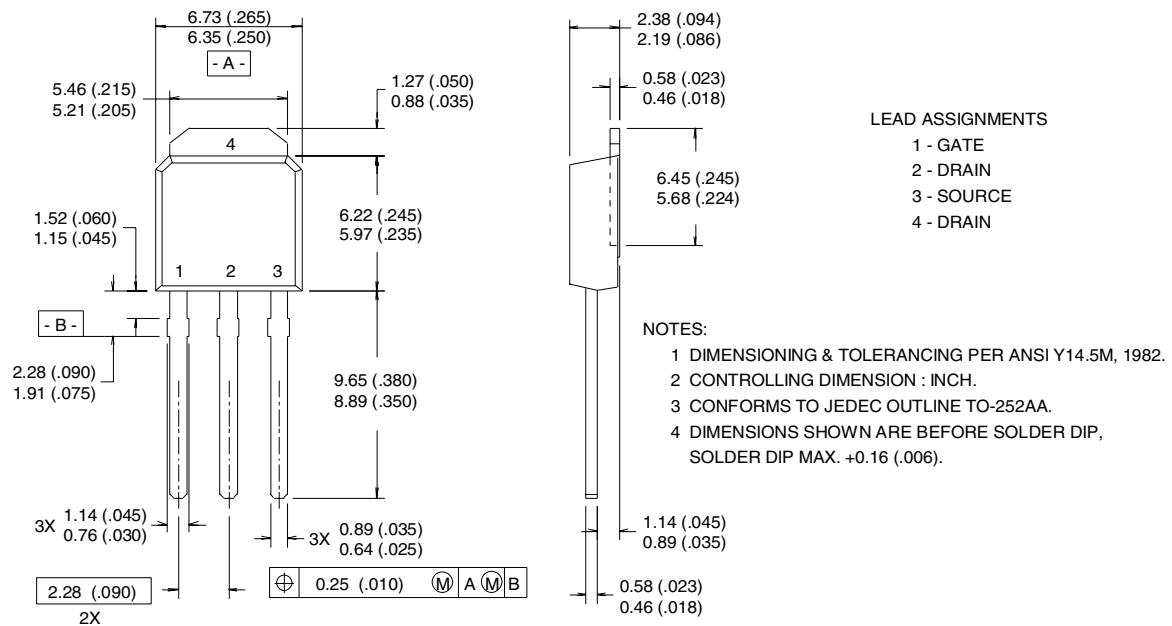

## I-Pak (TO-251AA) Part Marking Information

EXAMPLE: THIS IS AN IRFU120  
 LOT CODE 1789  
 ASSEMBLED ON WW 19, 1997  
 IN THE ASSEMBLY LINE "C"

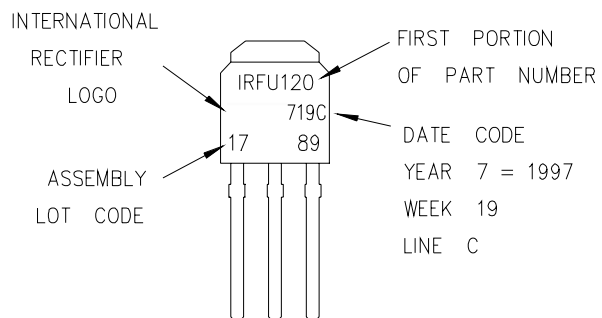



**KERSEMI**

# IRFR/U3505

## D-Pak (TO-252AA) Tape & Reel Information

Dimensions are shown in millimeters (inches)

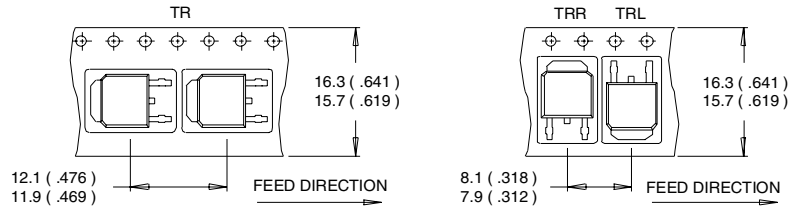

- NOTES :
1. CONTROLLING DIMENSION : MILLIMETER.
  2. ALL DIMENSIONS ARE SHOWN IN MILLIMETERS ( INCHES ).
  3. OUTLINE CONFORMS TO EIA-481 & EIA-541.

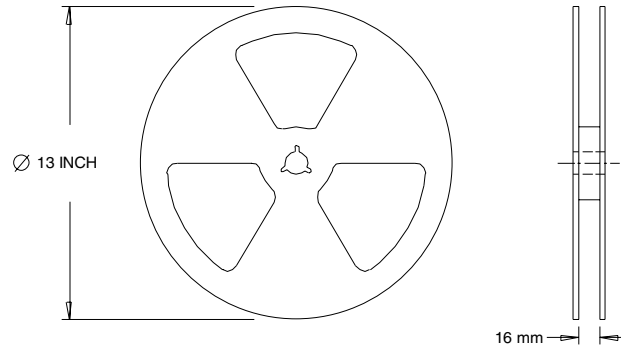

- NOTES :
1. OUTLINE CONFORMS TO EIA-481.

### Notes:

- ① Repetitive rating; pulse width limited by max. junction temperature. (See fig. 11).
- ② Limited by  $T_{Jmax}$ , starting  $T_J = 25^\circ C$ ,  $L = 0.47mH$ ,  $R_G = 25\Omega$ ,  $I_{AS} = 30A$ ,  $V_{GS} = 10V$ . Part not recommended for use above this value.
- ③  $I_{SD} \leq 30A$ ,  $di/dt \leq 300A/\mu s$ ,  $V_{DD} \leq V_{(BR)DSS}$ ,  $T_J \leq 175^\circ C$
- ④ Pulse width  $\leq 1.0ms$ ; duty cycle  $\leq 2\%$ .
- ⑤  $C_{OSS}$  eff. is a fixed capacitance that gives the same charging time as  $C_{OSS}$  while  $V_{DS}$  is rising from 0 to 80%  $V_{DSS}$ .
- ⑥ Limited by  $T_{Jmax}$ , see Fig.12a, 12b, 15, 16 for typical repetitive avalanche performance.
- ⑦ This value determined from sample failure population. 100% tested to this value in production.
- ⑧ When mounted on 1" square PCB (FR-4 or G-10 Material) . For recommended footprint and soldering techniques refer to application note #AN-994