



Integrated Device Technology, Inc.

# FAST CMOS OCTAL BIDIRECTIONAL TRANSCEIVERS

IDT54/74FCT245T/AT/CT/DT - 2245T/AT/CT  
IDT54/74FCT640T/AT/CT  
IDT54/74FCT645T/AT/CT/DT

## FEATURES:

- **Common features:**
  - Low input and output leakage  $\leq 1\mu\text{A}$  (max.)
  - CMOS power levels
  - True TTL input and output compatibility
    - $V_{OH} = 3.3\text{V}$  (typ.)
    - $V_{OL} = 0.3\text{V}$  (typ.)
  - Meets or exceeds JEDEC standard 18 specifications
  - Product available in Radiation Tolerant and Radiation Enhanced versions
  - Military product compliant to MIL-STD-883, Class B and DESC listed (dual marked)
  - Available in DIP, SOIC, SSOP, QSOP, CERPACK and LCC packages
- **Features for FCT245T/FCT640T/FCT645T:**
  - Std., A, C and D speed grades
  - High drive outputs (-15mA IOH, 64mA IOL)
- **Features for FCT2245T:**
  - Std., A and C speed grades
  - Resistor outputs (-15mA IOH, 12mA IOL Com.) (-12mA IOH, 12mA IOL Mil.)
  - Reduced system switching noise

## DESCRIPTION:

The IDT octal bidirectional transceivers are built using an advanced dual metal CMOS technology. The FCT245T/FCT2245T, FCT640T and FCT645T are designed for asynchronous two-way communication between data buses. The transmit/receive (T/R) input determines the direction of data flow through the bidirectional transceiver. Transmit (active HIGH) enables data from A ports to B ports, and receive (active LOW) from B ports to A ports. The output enable (OE) input, when HIGH, disables both A and B ports by placing them in HIGH Z condition.

The FCT245T/FCT2245T and FCT645T transceivers have non-inverting outputs. The FCT640T has inverting outputs.

The FCT2245T has balanced drive outputs with current limiting resistors. This offers low ground bounce, minimal undershoot and controlled output fall times- reducing the need for external series terminating resistors. The FCT2xxxT parts are plug-in replacements for FCTxxxT parts.

## FUNCTIONAL BLOCK DIAGRAM

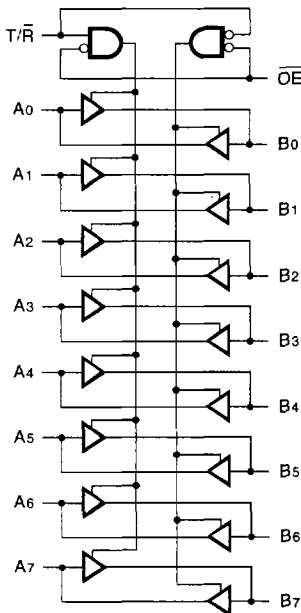

FCT245T/2245T, FCT645T are non-inverting options.  
FCT640T is the inverting options.

2539 drw 01

## PIN CONFIGURATIONS

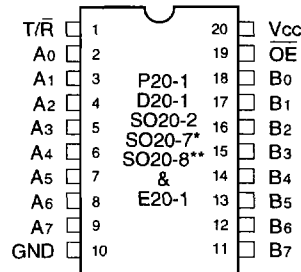

DIP/SOIC/SSOP/QSOP/CERPACK  
TOP VIEW

2539 drw 02

\*FCT245T/2245T, FCT645T only.  
\*\*FCT245T/2245T, FCT640T

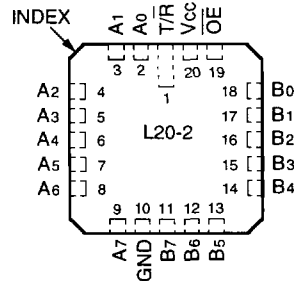

LCC  
TOP VIEW

2539 drw 03

The IDT logo is a registered trademark of Integrated Device Technology, Inc.

## MILITARY AND COMMERCIAL TEMPERATURE RANGES

JUNE 1996

**PIN DESCRIPTION**

Pin Names	Description
$\overline{OE}$	Output Enable Input (Active LOW)
$T/\overline{R}$	Transmit/Receive Input
A0-A7	Side A Inputs or 3-State Outputs
B0-B7	Side B Inputs or 3-State Outputs

2539 tbl 01

**FUNCTION TABLE<sup>(2)</sup>**

Inputs		Outputs
$\overline{OE}$	$T/\overline{R}$	
L	L	Bus B Data to Bus A <sup>(1)</sup>
L	H	Bus B Data to Bus B <sup>(1)</sup>
H	X	High Z State

2539 tbl 02

**NOTES:**

- 640 is inverting from input to output.
- H = HIGH Voltage Level  
 L = LOW Voltage Level  
 X = Don't Care

**ABSOLUTE MAXIMUM RATINGS<sup>(1)</sup>**

Symbol	Rating	Commercial	Military	Unit
$V_{TERM}^{(2)}$	Terminal Voltage with Respect to GND	-0.5 to +7.0	-0.5 to +7.0	V
$V_{TERM}^{(3)}$	Terminal Voltage with Respect to GND	-0.5 to $V_{CC}+0.5$	-0.5 to $V_{CC}+0.5$	V
$T_A$	Operating Temperature	0 to +70	-55 to +125	°C
$T_{BIAS}$	Temperature Under Bias	-55 to +125	-65 to +135	°C
$T_{STG}$	Storage Temperature	-55 to +125	-65 to +150	°C
$P_T$	Power Dissipation	0.5	0.5	W
$I_{OUT}$	DC Output Current	-60 to +120	-60 to +120	mA

2539 lmk 03

**NOTES:**

- Stresses greater than those listed under ABSOLUTE MAXIMUM RATINGS may cause permanent damage to the device. This is a stress rating only and functional operation of the device at these or any other conditions above those indicated in the operational sections of this specification is *not implied*. Exposure to absolute maximum rating conditions for extended periods may affect reliability. No terminal voltage may exceed  $V_{CC}$  by +0.5V unless otherwise noted.
- Input and  $V_{CC}$  terminals only.
- Outputs and I/O terminals only.

**CAPACITANCE ( $T_A = +25^\circ\text{C}$ ,  $F = 1.0\text{MHz}$ )**

Symbol	Parameter <sup>(1)</sup>	Conditions	Typ.	Max.	Unit
$C_{IN}$	Input Capacitance	$V_{IN} = 0V$	6	10	pF
$C_{OUT}$	Output Capacitance	$V_{OUT} = 0V$	8	12	pF

2539 lmk 04

**NOTE:**

- This parameter is measured at characterization but not tested.

## DC ELECTRICAL CHARACTERISTICS OVER OPERATING RANGE

Following Conditions Apply Unless Otherwise Specified:

Commercial: TA = 0°C to +70°C, VCC = 5.0V ± 5%; Military: TA = -55°C to +125°C, VCC = 5.0V ± 10%

Symbol	Parameter	Test Conditions <sup>(1)</sup>	Min.	Typ. <sup>(2)</sup>	Max.	Unit
V <sub>IH</sub>	Input HIGH Level	Guaranteed Logic HIGH Level	2.0	—	—	V
V <sub>IL</sub>	Input LOW Level	Guaranteed Logic LOW Level	—	—	0.8	V
I <sub>IH</sub>	Input HIGH Current <sup>(4)</sup>	VCC = Max. V <sub>I</sub> = 2.7V	—	—	±1	μA
I <sub>IL</sub>	Input LOW Current <sup>(4)</sup>		V <sub>I</sub> = 0.5V	—	—	
I <sub>OZH</sub>	High Impedance Output Current (3-State Output pins) <sup>(4)</sup>	VCC = Max. V <sub>O</sub> = 2.7V	—	—	±1	μA
I <sub>OZL</sub>			V <sub>O</sub> = 0.5V	—	—	
I <sub>I</sub>	Input HIGH Current <sup>(4)</sup>	VCC = Max., V <sub>I</sub> = VCC (Max.)	—	—	±1	μA
V <sub>IK</sub>	Clamp Diode Voltage	VCC = Min., I <sub>IN</sub> = -18mA	—	-0.7	-1.2	V
V <sub>H</sub>	Input Hysteresis	—	—	200	—	mV
I <sub>CC</sub>	Quiescent Power Supply Current	VCC = Max., V <sub>IN</sub> = GND or VCC	—	0.01	1	mA

2539 Ink 05

## OUTPUT DRIVE CHARACTERISTICS FOR FCT245T/640T/645T

Symbol	Parameter	Test Conditions <sup>(1)</sup>	Min.	Typ. <sup>(2)</sup>	Max.	Unit	
V <sub>OH</sub>	Output HIGH Voltage	VCC = Min. V <sub>IN</sub> = V <sub>IH</sub> or V <sub>IL</sub>	I <sub>OH</sub> = -6mA MIL.	2.4	3.3	—	V
			I <sub>OH</sub> = -8mA COM'L.	2.0	3.0	—	V
			I <sub>OH</sub> = -12mA MIL. I <sub>OH</sub> = -15mA COM'L.				
V <sub>OL</sub>	Output LOW Voltage	VCC = Min. V <sub>IN</sub> = V <sub>IH</sub> or V <sub>IL</sub>	—	0.3	0.55	V	
I <sub>OS</sub>	Short Circuit Current	VCC = Max., V <sub>O</sub> = GND <sup>(3)</sup>	-60	-120	-225	mA	

2539 Ink 06

## OUTPUT DRIVE CHARACTERISTICS FOR FCT2245T

Symbol	Parameter	Test Conditions <sup>(1)</sup>	Min.	Typ. <sup>(2)</sup>	Max.	Unit	
I <sub>ODL</sub>	Output LOW Current	VCC = 5V, V <sub>IN</sub> = V <sub>IH</sub> or V <sub>IL</sub> , V <sub>OUT</sub> = 1.5V <sup>(3)</sup>	16	48	—	mA	
I <sub>ODH</sub>	Output HIGH Current	VCC = 5V, V <sub>IN</sub> = V <sub>IH</sub> or V <sub>IL</sub> , V <sub>OUT</sub> = 1.5V <sup>(3)</sup>	-16	-48	—	mA	
V <sub>OH</sub>	Output HIGH Voltage	VCC = Min. V <sub>IN</sub> = V <sub>IH</sub> or V <sub>IL</sub>	I <sub>OH</sub> = -12mA MIL.	2.4	3.3	—	V
			I <sub>OH</sub> = -15mA COM'L.				
V <sub>OL</sub>	Output LOW Voltage	VCC = Min. V <sub>IN</sub> = V <sub>IH</sub> or V <sub>IL</sub>	—	0.3	0.50	V	

2539 Ink 07

### NOTES:

- For conditions shown as Max. or Min., use appropriate value specified under Electrical Characteristics for the applicable device type.
- Typical values are at VCC = 5.0V, +25°C ambient.
- Not more than one output should be shorted at one time. Duration of the short circuit test should not exceed one second.
- The test limit for this parameter is ±5μA at TA = -55°C.

6

## POWER SUPPLY CHARACTERISTICS

Symbol	Parameter	Test Conditions <sup>(1)</sup>			Min.	Typ. <sup>(2)</sup>	Max.	Unit
$\Delta I_{CC}$	Quiescent Power Supply Current TTL Inputs HIGH	V <sub>CC</sub> = Max. V <sub>IN</sub> = 3.4V <sup>(3)</sup>			—	0.5	2.0	mA
I <sub>CCD</sub>	Dynamic Power Supply Current <sup>(4)</sup>	V <sub>CC</sub> = Max. Outputs Open $\overline{OE} = T/\overline{R} = GND$ One Input Toggling 50% Duty Cycle	V <sub>IN</sub> = V <sub>CC</sub> V <sub>IN</sub> = GND	FCTxxxT FCT2xxxT	— —	0.15 0.06	0.25 0.12	mA/ MHz
I <sub>C</sub>	Total Power Supply Current <sup>(6)</sup>	V <sub>CC</sub> = Max. Outputs Open f <sub>i</sub> = 10MHz 50% Duty Cycle $\overline{OE} = T/\overline{R} = GND$ One Bit Toggling	V <sub>IN</sub> = V <sub>CC</sub> V <sub>IN</sub> = GND V <sub>IN</sub> = 3.4 V <sub>IN</sub> = GND	FCTxxxT FCT2xxxT FCTxxxT FCT2xxxT	— — — —	1.5 0.6 1.8 0.9	3.5 2.2 4.5 3.2	mA
		V <sub>CC</sub> = Max. Outputs Open f <sub>i</sub> = 2.5MHz 50% Duty Cycle $\overline{OE} = T/\overline{R} = GND$ Eight Bits Toggling	V <sub>IN</sub> = V <sub>CC</sub> V <sub>IN</sub> = GND V <sub>IN</sub> = 3.4 V <sub>IN</sub> = GND	FCTxxxT FCT2xxxT FCTxxxT FCT2xxxT	— — — —	3.0 1.2 5.0 3.2	6.0 <sup>(5)</sup> 3.4 <sup>(5)</sup> 14.0 <sup>(5)</sup> 11.4 <sup>(5)</sup>	

2539 tbl 08

### NOTES:

- For conditions shown as Max. or Min., use appropriate value specified under Electrical Characteristics for the applicable device type.
- Typical values are at V<sub>CC</sub> = 5.0V, +25°C ambient.
- Per TTL driven input (V<sub>IN</sub> = 3.4V). All other inputs at V<sub>CC</sub> or GND.
- This parameter is not directly testable, but is derived for use in Total Power Supply Calculations.
- Values for these conditions are examples of the I<sub>CC</sub> formula. These limits are guaranteed but not tested.
- I<sub>C</sub> = I<sub>QUIESCENT</sub> + I<sub>INPUTS</sub> + I<sub>DYNAMIC</sub>  
 $I_C = I_{CC} + \Delta I_{CC} D_H N_T + I_{CCD} (f_{CP}/2 + f_i N_i)$   
 I<sub>CC</sub> = Quiescent Current  
 $\Delta I_{CC}$  = Power Supply Current for a TTL High Input (V<sub>IN</sub> = 3.4V)  
 D<sub>H</sub> = Duty Cycle for TTL Inputs High  
 N<sub>T</sub> = Number of TTL Inputs at D<sub>H</sub>  
 I<sub>CCD</sub> = Dynamic Current Caused by an Input Transition Pair (HLH or LHL)  
 f<sub>CP</sub> = Clock Frequency for Register Devices (Zero for Non-Register Devices)  
 f<sub>i</sub> = Input Frequency  
 N<sub>i</sub> = Number of Inputs at f<sub>i</sub>  
 All currents are in milliamps and all frequencies are in megahertz.

**SWITCHING CHARACTERISTICS OVER OPERATING RANGE**

Symbol	Parameter	Conditions <sup>(1)</sup>	FCT245T FCT2245T				FCT245AT FCT2245AT				Unit
			Com'l.		Mil.		Com'l.		Mil.		
			Min. <sup>(2)</sup>	Max.	Min. <sup>(2)</sup>	Max.	Min. <sup>(2)</sup>	Max.	Min. <sup>(2)</sup>	Max.	
tPLH tPHL	Propagation Delay A to B, B to A	CL = 50 pF RL = 500Ω	1.5	7.0	1.5	7.5	1.5	4.6	1.5	4.9	ns
tPZH tPZL	Output Enable Time OE to A or B		1.5	9.5	1.5	10.0	1.5	6.2	1.5	6.5	ns
tPHZ tPLZ	Output Disable Time OE to A or B		1.5	7.5	1.5	10.0	1.5	5.0	1.5	6.0	ns
tPZH tPZL	Output Enable Time T/R to A or B <sup>(3)</sup>		1.5	9.5	1.5	10.0	1.5	6.2	1.5	6.5	ns
tPHZ tPLZ	Output Disable Time T/R to A or B <sup>(3)</sup>		1.5	7.5	1.5	10.0	1.5	5.0	1.5	6.0	ns

2534 tbi 09

Symbol	Parameter	Conditions <sup>(1)</sup>	FCT245CT FCT2245CT				FCT245DT				Unit
			Com'l.		Mil.		Com'l.		Mil.		
			Min. <sup>(2)</sup>	Max.	Min. <sup>(2)</sup>	Max.	Min. <sup>(2)</sup>	Max.	Min. <sup>(2)</sup>	Max.	
tPLH tPHL	Propagation Delay A to B, B to A	CL = 50 pF RL = 500Ω	1.5	4.1	1.5	4.5	1.5	3.8	—	—	ns
tPZH tPZL	Output Enable Time OE to A or B		1.5	5.8	1.5	6.2	1.5	5.0	—	—	ns
tPHZ tPLZ	Output Disable Time OE to A or B		1.5	4.8	1.5	5.2	1.5	4.3	—	—	ns
tPZH tPZL	Output Enable Time T/R to A or B <sup>(3)</sup>		1.5	5.8	1.5	6.2	1.5	5.0	—	—	ns
tPHZ tPLZ	Output Disable Time T/R to A or B <sup>(3)</sup>		1.5	4.8	1.5	5.2	1.5	4.3	—	—	ns

2534 tbi 10

**6**

**SWITCHING CHARACTERISTICS OVER OPERATING RANGE**

Symbol	Parameter	Conditions <sup>(1)</sup>	FCT640T				FCT640AT				FCT640CT				Unit
			Com'l.		Mil.		Com'l.		Mil.		Com'l.		Mil.		
			Min. <sup>(2)</sup>	Max.	Min. <sup>(2)</sup>	Max.	Min. <sup>(2)</sup>	Max.	Min. <sup>(2)</sup>	Max.	Min. <sup>(2)</sup>	Max.	Min. <sup>(2)</sup>	Max.	
tPLH tPHL	Propagation Delay A to B, B to A	CL = 50 pF RL = 500Ω	2.0	7.0	2.0	8.0	1.5	5.0	1.5	5.3	1.5	4.4	1.5	4.7	ns
tPZH tPZL	Output Enable Time OE to A or B		2.0	13.0	2.0	16.0	1.5	6.2	1.5	6.5	1.5	5.8	1.5	6.2	ns
tPHZ tPLZ	Output Disable Time OE to A or B		2.0	10.0	2.0	12.0	1.5	5.0	1.5	6.0	1.5	4.8	1.5	5.2	ns
tPZH tPZL	Output Enable Time T/R to A or B <sup>(3)</sup>		2.0	13.0	2.0	16.0	1.5	6.2	1.5	6.5	1.5	5.8	1.5	6.2	ns
tPHZ tPLZ	Output Disable Time T/R to A or B <sup>(3)</sup>		2.0	10.0	2.0	12.0	1.5	5.0	1.5	6.0	1.5	4.8	1.5	5.2	ns

**NOTES:**

2534 tbi 11

1. See test circuit and waveforms.
2. Minimum limits are guaranteed but not tested on Propagation Delays.
3. This parameter is guaranteed but not tested.

**SWITCHING CHARACTERISTICS OVER OPERATING RANGE**

Symbol	Parameter	Conditions <sup>(1)</sup>	FCT645T				FCT645AT				Unit
			Com'l.		Mil.		Com'l.		Mil.		
			Min. <sup>(2)</sup>	Max.	Min. <sup>(2)</sup>	Max.	Min. <sup>(2)</sup>	Max.	Min. <sup>(2)</sup>	Max.	
tPLH	Propagation Delay	CL = 50 pF RL = 500Ω	1.5	9.5	1.5	11.0	1.5	4.6	1.5	4.9	ns
tPHL	A to B, B to A										
tPZH	Output Enable Time		1.5	11.0	1.5	12.0	1.5	6.2	1.5	6.5	ns
tPZL	$\overline{OE}$ to A or B										
tPHZ	Output Disable Time		1.5	12.0	1.5	13.0	1.5	5.0	1.5	6.0	ns
tPLZ	$\overline{OE}$ to A or B										
tPZH	Output Enable Time	T/ $\overline{R}$ to A or B <sup>(3)</sup>	1.5	11.0	1.5	12.0	1.5	6.2	1.5	6.5	ns
tPZL	T/ $\overline{R}$ to A or B <sup>(3)</sup>										
tPHZ	Output Disable Time	T/ $\overline{R}$ to A or B <sup>(3)</sup>	1.5	12.0	1.5	13.0	1.5	5.0	1.5	6.0	ns
tPLZ	T/ $\overline{R}$ to A or B <sup>(3)</sup>										

2534 tbl 12

Symbol	Parameter	Conditions <sup>(1)</sup>	FCT645CT				FCT645DT				Unit
			Com'l.		Mil.		Com'l.		Mil.		
			Min. <sup>(2)</sup>	Max.	Min. <sup>(2)</sup>	Max.	Min. <sup>(2)</sup>	Max.	Min. <sup>(2)</sup>	Max.	
tPLH	Propagation Delay	CL = 50 pF RL = 500Ω	1.5	4.1	1.5	4.5	1.5	3.8	—	—	ns
tPHL	A to B, B to A										
tPZH	Output Enable Time		1.5	5.8	1.5	6.2	1.5	5.0	—	—	ns
tPZL	$\overline{OE}$ to A or B										
tPHZ	Output Disable Time		1.5	4.8	1.5	5.2	1.5	4.3	—	—	ns
tPLZ	$\overline{OE}$ to A or B										
tPZH	Output Enable Time	T/ $\overline{R}$ to A or B <sup>(3)</sup>	1.5	5.8	1.5	6.2	1.5	5.0	—	—	ns
tPZL	T/ $\overline{R}$ to A or B <sup>(3)</sup>										
tPHZ	Output Disable Time	T/ $\overline{R}$ to A or B <sup>(3)</sup>	1.5	4.8	1.5	5.2	1.5	4.3	—	—	ns
tPLZ	T/ $\overline{R}$ to A or B <sup>(3)</sup>										

2534 tbl 13

**NOTES:**

1. See test circuit and waveforms.
2. Minimum limits are guaranteed but not tested on Propagation Delays.
3. This parameter is guaranteed but not tested.

## TEST CIRCUITS AND WAVEFORMS

### TEST CIRCUITS FOR ALL OUTPUTS

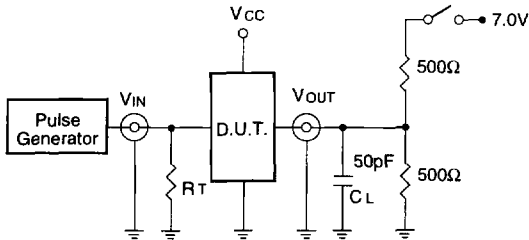

2534 drw 04

### SWITCH POSITION

Test	Switch
Open Drain	Closed
Disable Low	
Enable Low	
All Other Tests	Open

#### DEFINITIONS:

CL = Load capacitance: includes jig and probe capacitance.  
 RT = Termination resistance: should be equal to Zout of the Pulse Generator.

2534 Ink 14

### SET-UP, HOLD AND RELEASE TIMES

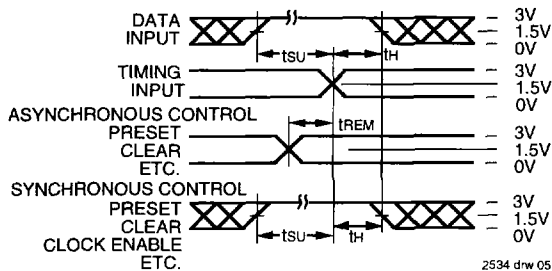

2534 drw 05

### PULSE WIDTH

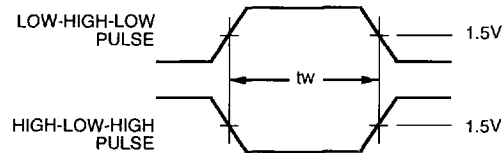

2534 drw 06

### PROPAGATION DELAY

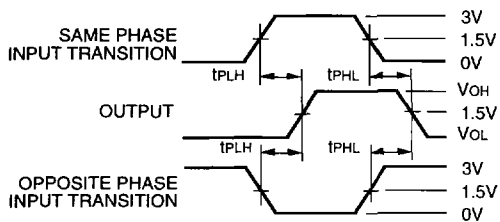

2534 drw 07

### ENABLE AND DISABLE TIMES

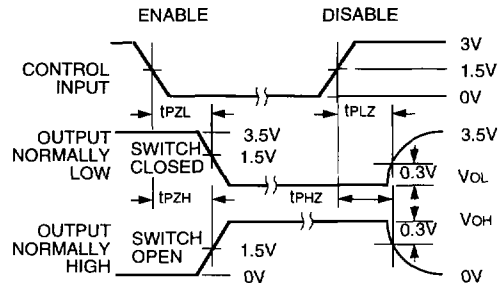

2534 drw 08

#### NOTES:

1. Diagram shown for input Control Enable-LOW and input Control Disable-HIGH
2. Pulse Generator for All Pulses: Rate  $\leq 1.0\text{MHz}$ ;  $t_r \leq 2.5\text{ns}$ ;  $t_s \leq 2.5\text{ns}$

**ORDERING INFORMATION**

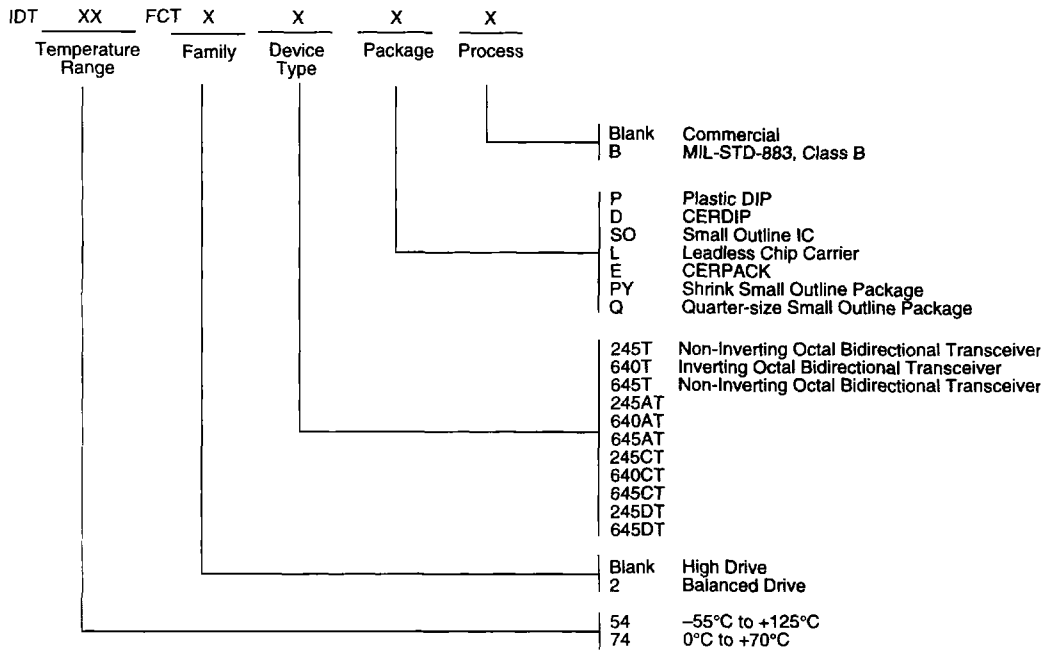

2539 drw 09