

# MMBT3906L, SMMBT3906L

## General Purpose Transistor

### PNP Silicon

#### Features

- AEC-Q101 Qualified and PPAP Capable
- S Prefix for Automotive and Other Applications Requiring Unique Site and Control Change Requirements
- These Devices are Pb-Free, Halogen Free/BFR Free and are RoHS Compliant

#### MAXIMUM RATINGS

Rating	Symbol	Value	Unit
Collector - Emitter Voltage	$V_{CEO}$	-40	Vdc
Collector - Base Voltage	$V_{CBO}$	-40	Vdc
Emitter - Base Voltage	$V_{EBO}$	-5.0	Vdc
Collector Current - Continuous	$I_C$	-200	mAdc
Collector Current - Peak (Note 3)	$I_{CM}$	-800	mAdc

#### THERMAL CHARACTERISTICS

Characteristic	Symbol	Max	Unit
Total Device Dissipation FR-5 Board (Note 1) @ $T_A = 25^\circ\text{C}$ Derate above $25^\circ\text{C}$	$P_D$	225 1.8	mW mW/ $^\circ\text{C}$
Thermal Resistance, Junction-to-Ambient	$R_{\theta JA}$	556	$^\circ\text{C}/\text{W}$
Total Device Dissipation Alumina Substrate, (Note 2) @ $T_A = 25^\circ\text{C}$ Derate above $25^\circ\text{C}$	$P_D$	300 2.4	mW mW/ $^\circ\text{C}$
Thermal Resistance, Junction-to-Ambient	$R_{\theta JA}$	417	$^\circ\text{C}/\text{W}$
Junction and Storage Temperature	$T_J, T_{stg}$	-55 to +150	$^\circ\text{C}$

Stresses exceeding Maximum Ratings may damage the device. Maximum Ratings are stress ratings only. Functional operation above the Recommended Operating Conditions is not implied. Extended exposure to stresses above the Recommended Operating Conditions may affect device reliability.

1. FR-5 =  $1.0 \times 0.75 \times 0.062$  in.
2. Alumina =  $0.4 \times 0.3 \times 0.024$  in. 99.5% alumina.
3. Reference SOA curve.



ON Semiconductor®

<http://onsemi.com>

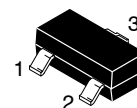
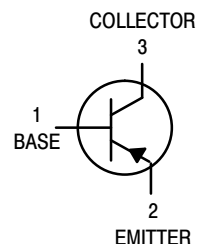

SOT-23 (TO-236)  
CASE 318  
STYLE 6

#### MARKING DIAGRAM

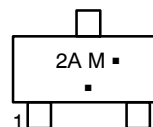

2A = Specific Device Code  
M = Date Code\*  
▪ = Pb-Free Package

(Note: Microdot may be in either location)

\*Date Code orientation and/or overbar may vary depending upon manufacturing location.

#### ORDERING INFORMATION

Device	Package	Shipping†
MMBT3906LT1G	SOT-23 (Pb-Free)	3,000 / Tape & Reel
MMBT3906LT3G	SOT-23 (Pb-Free)	10,000 / Tape & Reel
SMMBT3906LT1G	SOT-23 (Pb-Free)	3,000 / Tape & Reel
SSMBT3906LT3G	SOT-23 (Pb-Free)	10,000 / Tape & Reel

†For information on tape and reel specifications, including part orientation and tape sizes, please refer to our Tape and Reel Packaging Specifications Brochure, BRD8011/D.

# MMBT3906L, SMMBT3906L

## ELECTRICAL CHARACTERISTICS ( $T_A = 25^\circ\text{C}$ unless otherwise noted)

Characteristic	Symbol	Min	Max	Unit
<b>OFF CHARACTERISTICS</b>				
Collector – Emitter Breakdown Voltage ( $I_C = -1.0\text{ mAdc}$ , $I_B = 0$ )	$V_{(BR)CEO}$	-40	-	Vdc
Collector – Base Breakdown Voltage ( $I_C = -10\ \mu\text{Adc}$ , $I_E = 0$ )	$V_{(BR)CBO}$	-40	-	Vdc
Emitter – Base Breakdown Voltage ( $I_E = -10\ \mu\text{Adc}$ , $I_C = 0$ )	$V_{(BR)EBO}$	-5.0	-	Vdc
Base Cutoff Current ( $V_{CE} = -30\text{ Vdc}$ , $V_{EB} = -3.0\text{ Vdc}$ )	$I_{BL}$	-	-50	nAdc
Collector Cutoff Current ( $V_{CE} = -30\text{ Vdc}$ , $V_{EB} = -3.0\text{ Vdc}$ )	$I_{CEX}$	-	-50	nAdc

## ON CHARACTERISTICS (Note 4)

DC Current Gain ( $I_C = -0.1\text{ mAdc}$ , $V_{CE} = -1.0\text{ Vdc}$ ) ( $I_C = -1.0\text{ mAdc}$ , $V_{CE} = -1.0\text{ Vdc}$ ) ( $I_C = -10\text{ mAdc}$ , $V_{CE} = -1.0\text{ Vdc}$ ) ( $I_C = -50\text{ mAdc}$ , $V_{CE} = -1.0\text{ Vdc}$ ) ( $I_C = -100\text{ mAdc}$ , $V_{CE} = -1.0\text{ Vdc}$ )	$H_{FE}$	60 80 100 60 30	- - 300 - -	-
Collector – Emitter Saturation Voltage ( $I_C = -10\text{ mAdc}$ , $I_B = -1.0\text{ mAdc}$ ) ( $I_C = -50\text{ mAdc}$ , $I_B = -5.0\text{ mAdc}$ )	$V_{CE(sat)}$	- -	-0.25 -0.4	Vdc
Base – Emitter Saturation Voltage ( $I_C = -10\text{ mAdc}$ , $I_B = -1.0\text{ mAdc}$ ) ( $I_C = -50\text{ mAdc}$ , $I_B = -5.0\text{ mAdc}$ )	$V_{BE(sat)}$	-0.65 -	-0.85 -0.95	Vdc

## SMALL-SIGNAL CHARACTERISTICS

Current – Gain – Bandwidth Product ( $I_C = -10\text{ mAdc}$ , $V_{CE} = -20\text{ Vdc}$ , $f = 100\text{ MHz}$ )	$f_T$	250	-	MHz
Output Capacitance ( $V_{CB} = -5.0\text{ Vdc}$ , $I_E = 0$ , $f = 1.0\text{ MHz}$ )	$C_{obo}$	-	4.5	pF
Input Capacitance ( $V_{EB} = -0.5\text{ Vdc}$ , $I_C = 0$ , $f = 1.0\text{ MHz}$ )	$C_{ibo}$	-	10	pF
Input Impedance ( $I_C = -1.0\text{ mAdc}$ , $V_{CE} = -10\text{ Vdc}$ , $f = 1.0\text{ kHz}$ )	$h_{ie}$	2.0	12	k $\Omega$
Voltage Feedback Ratio ( $I_C = -1.0\text{ mAdc}$ , $V_{CE} = -10\text{ Vdc}$ , $f = 1.0\text{ kHz}$ )	$h_{re}$	0.1	10	$\times 10^{-4}$
Small – Signal Current Gain ( $I_C = -1.0\text{ mAdc}$ , $V_{CE} = -10\text{ Vdc}$ , $f = 1.0\text{ kHz}$ )	$h_{fe}$	100	400	-
Output Admittance ( $I_C = -1.0\text{ mAdc}$ , $V_{CE} = -10\text{ Vdc}$ , $f = 1.0\text{ kHz}$ )	$h_{oe}$	3.0	60	$\mu\text{mhos}$
Noise Figure ( $I_C = -100\ \mu\text{Adc}$ , $V_{CE} = -5.0\text{ Vdc}$ , $R_S = 1.0\text{ k}\Omega$ , $f = 1.0\text{ kHz}$ )	NF	-	4.0	dB

## SWITCHING CHARACTERISTICS

Delay Time	$(V_{CC} = -3.0\text{ Vdc}$ , $V_{BE} = 0.5\text{ Vdc}$ , $I_C = -10\text{ mAdc}$ , $I_{B1} = -1.0\text{ mAdc}$ )	$t_d$	-	35	ns
Rise Time		$t_r$	-	35	
Storage Time	$(V_{CC} = -3.0\text{ Vdc}$ , $I_C = -10\text{ mAdc}$ , $I_{B1} = I_{B2} = -1.0\text{ mAdc}$ )	$t_s$	-	225	ns
Fall Time		$t_f$	-	75	

4. Pulse Test: Pulse Width  $\leq 300\ \mu\text{s}$ , Duty Cycle  $\leq 2.0\%$ .

# MMBT3906L, SMMBT3906L

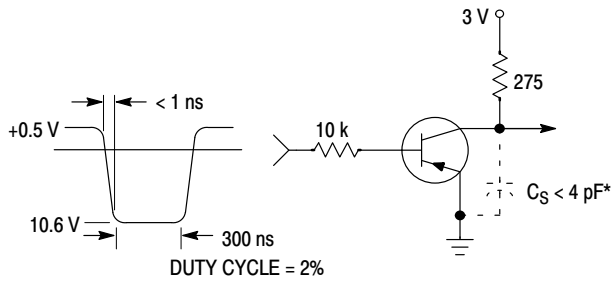

**Figure 1. Delay and Rise Time Equivalent Test Circuit**

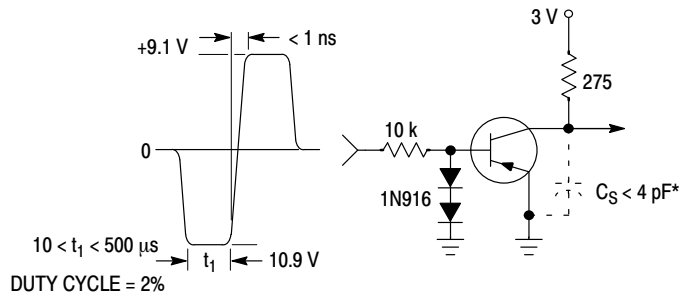
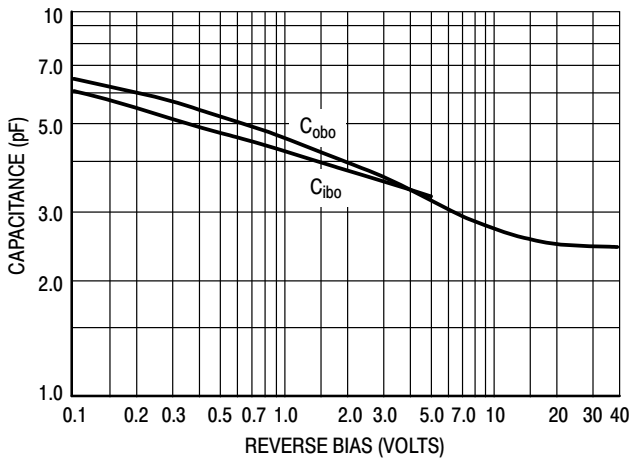

**Figure 2. Storage and Fall Time Equivalent Test Circuit**

\* Total shunt capacitance of test jig and connectors

## TYPICAL TRANSIENT CHARACTERISTICS

—  $T_J = 25^\circ\text{C}$   
 - - -  $T_J = 125^\circ\text{C}$



**Figure 3. Capacitance**

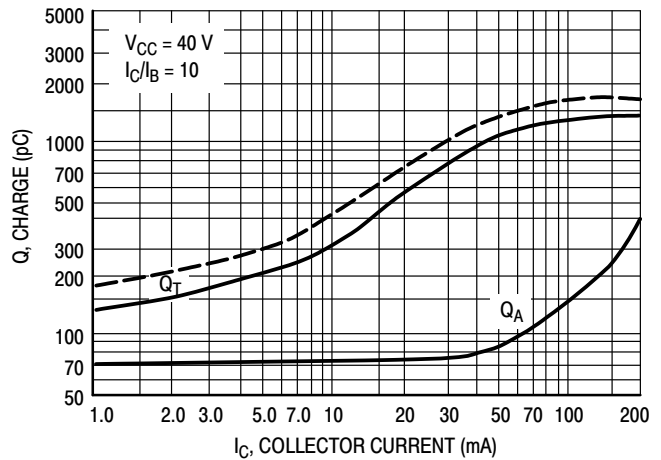

**Figure 4. Charge Data**

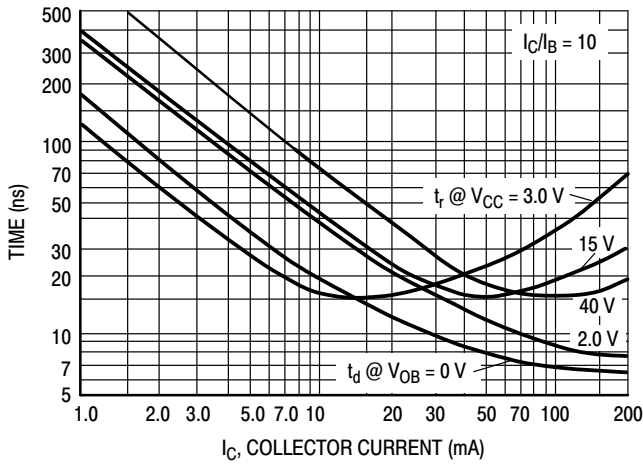

**Figure 5. Turn-On Time**

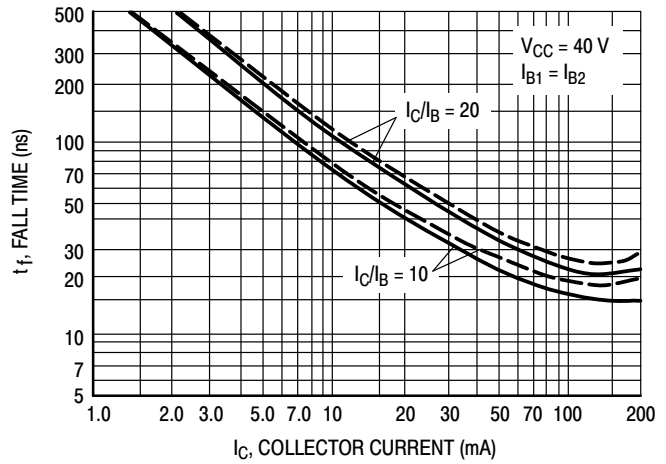

**Figure 6. Fall Time**

# MMBT3906L, SMMBT3906L

## TYPICAL AUDIO SMALL-SIGNAL CHARACTERISTICS NOISE FIGURE VARIATIONS

( $V_{CE} = -5.0$  Vdc,  $T_A = 25^\circ\text{C}$ , Bandwidth = 1.0 Hz)

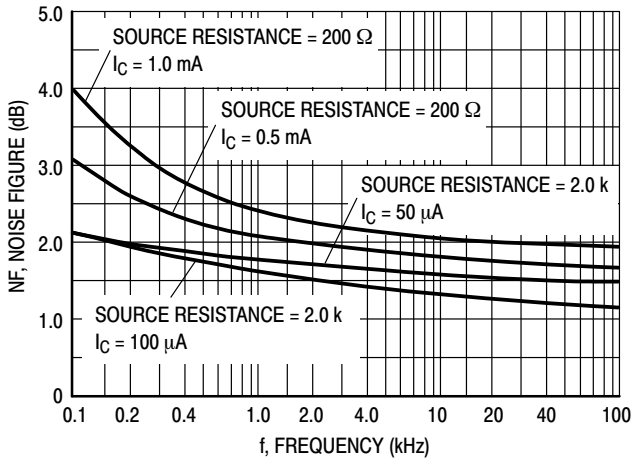

Figure 7.

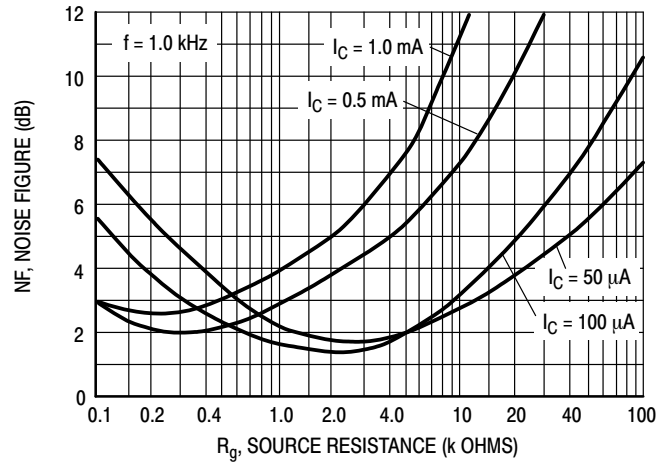

Figure 8.

## h PARAMETERS

( $V_{CE} = -10$  Vdc,  $f = 1.0$  kHz,  $T_A = 25^\circ\text{C}$ )

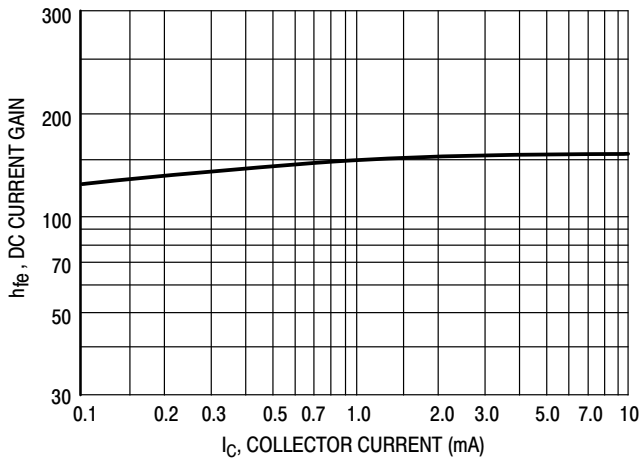

Figure 9. Current Gain

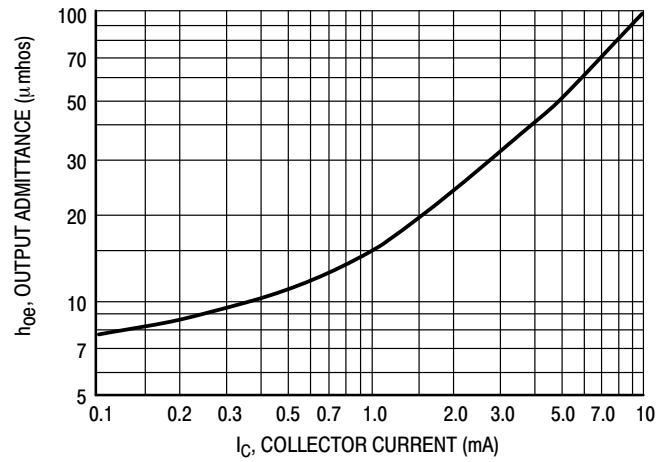

Figure 10. Output Admittance

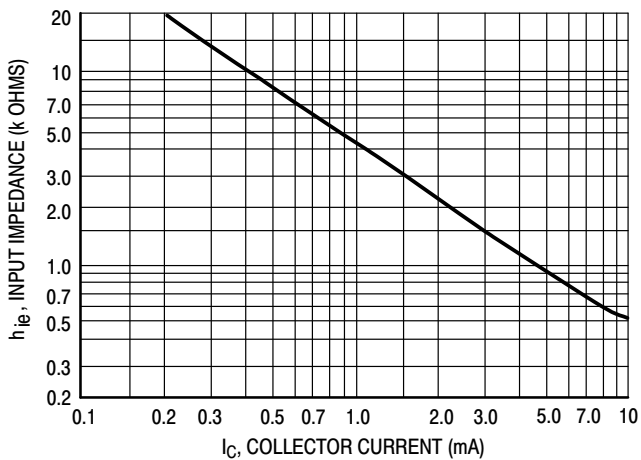

Figure 11. Input Impedance

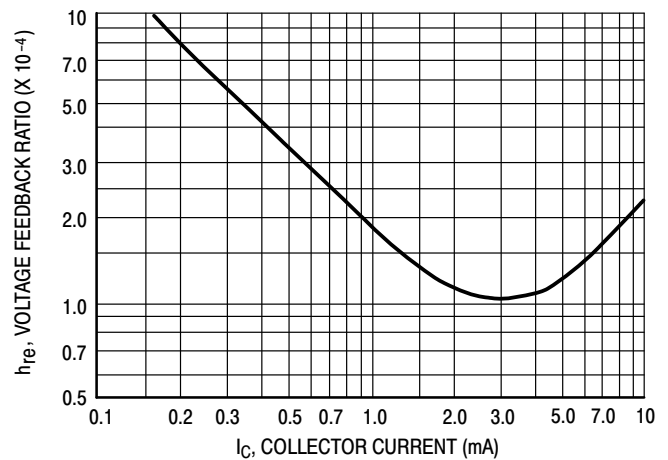

Figure 12. Voltage Feedback Ratio

# MMBT3906L, SMMBT3906L

## TYPICAL STATIC CHARACTERISTICS

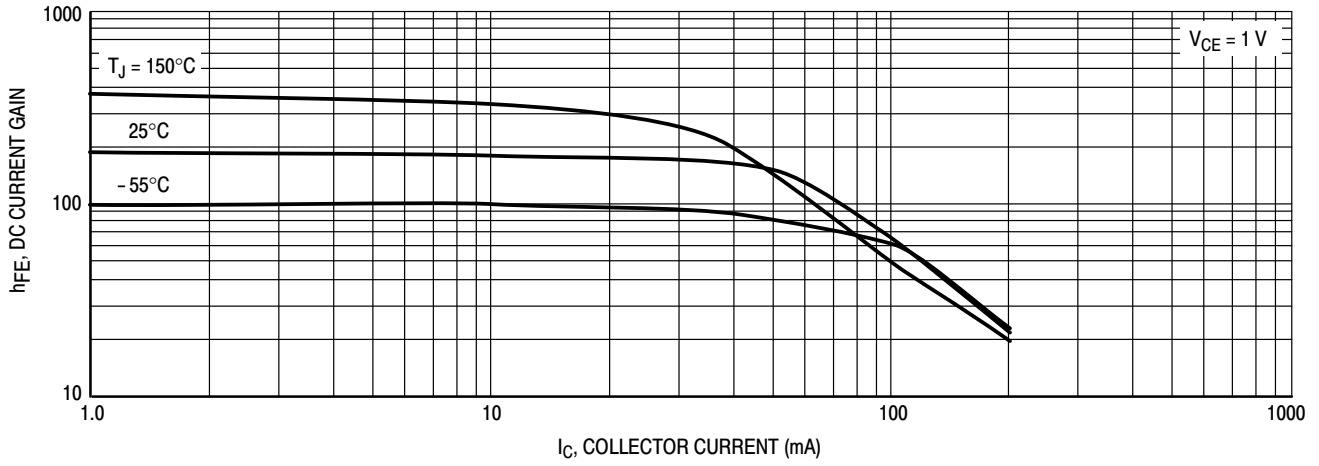

Figure 13. DC Current Gain

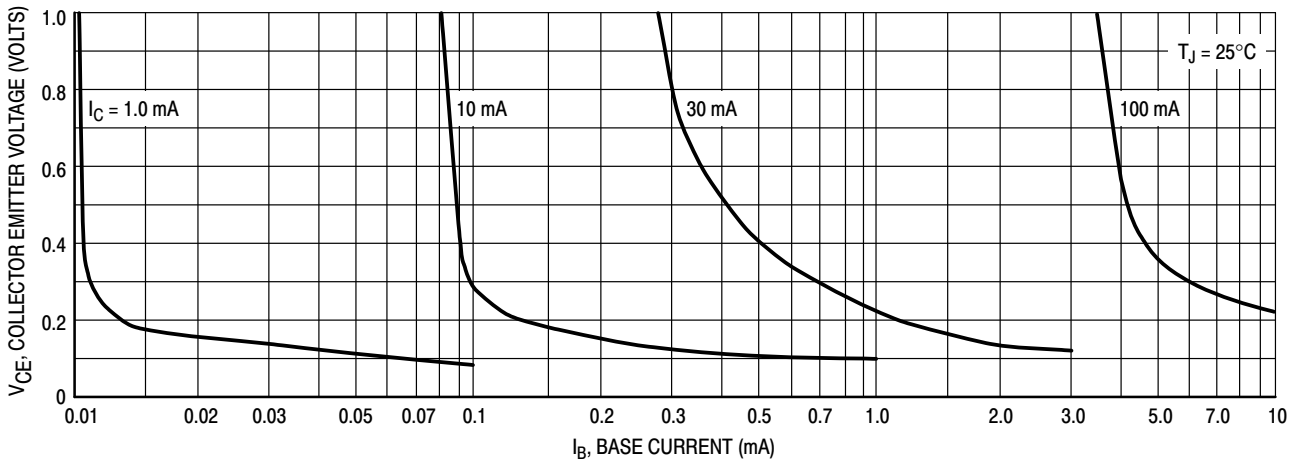
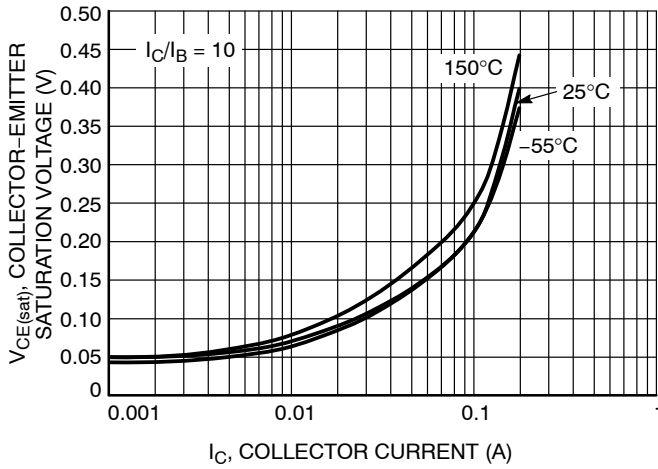
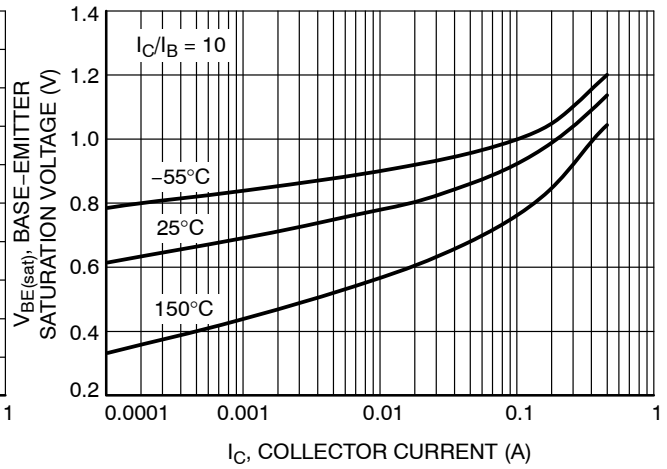

Figure 14. Collector Saturation Region

# MMBT3906L, SMMBT3906L



**Figure 15. Collector Emitter Saturation Voltage vs. Collector Current**



**Figure 16. Base Emitter Saturation Voltage vs. Collector Current**

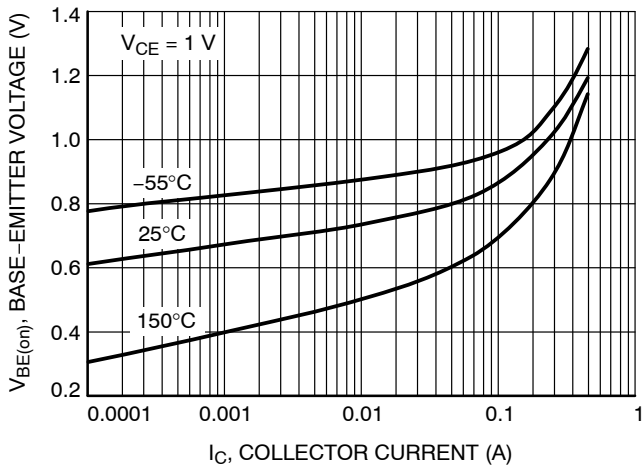

**Figure 17. Base Emitter Voltage vs. Collector Current**

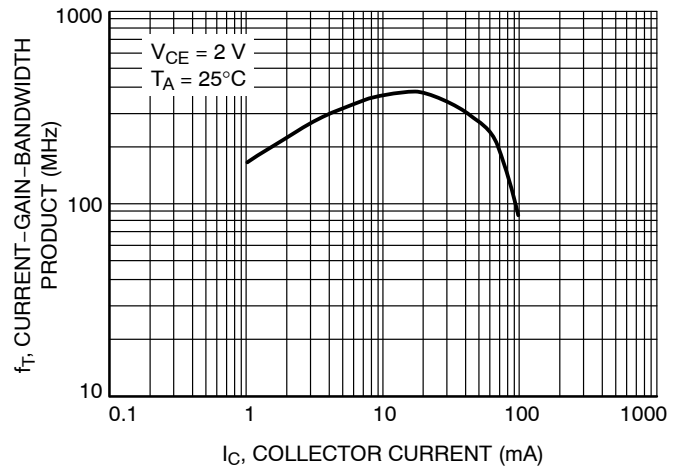

**Figure 18. Current Gain Bandwidth vs. Collector Current**

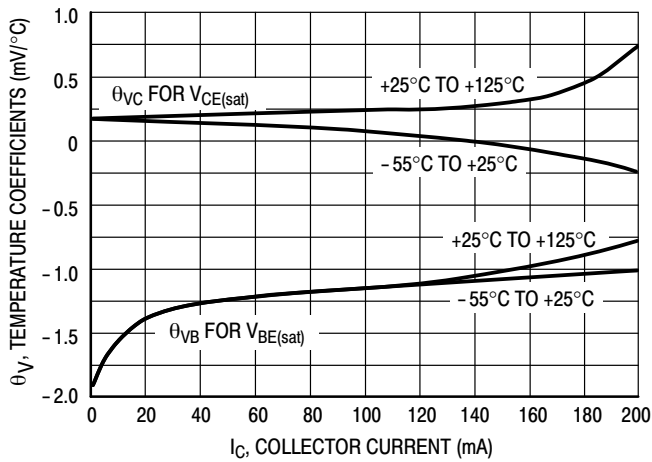

**Figure 19. Temperature Coefficients**

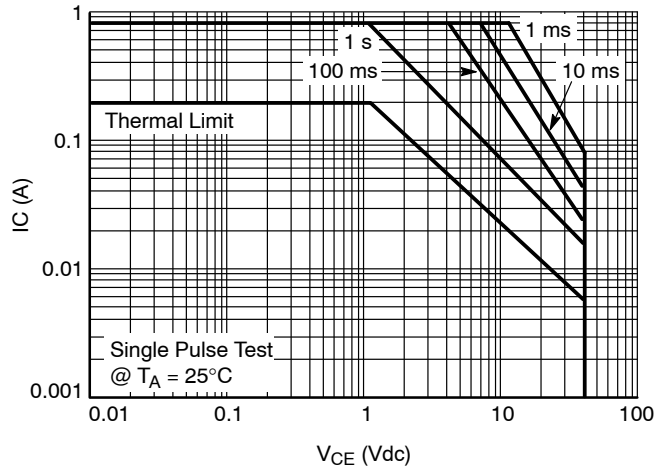
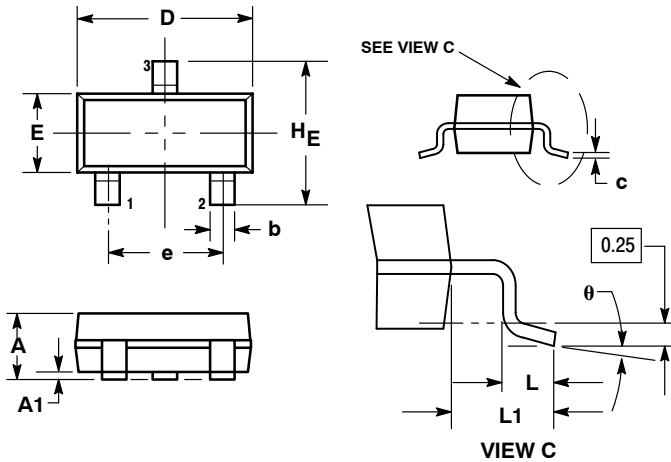

**Figure 20. Safe Operating Area**

# MMBT3906L, SMMBT3906L

## PACKAGE DIMENSIONS

SOT-23 (TO-236)  
CASE 318-08  
ISSUE AP



NOTES:

1. DIMENSIONING AND TOLERANCING PER ANSI Y14.5M, 1982.
2. CONTROLLING DIMENSION: INCH.
3. MAXIMUM LEAD THICKNESS INCLUDES LEAD FINISH THICKNESS. MINIMUM LEAD THICKNESS IS THE MINIMUM THICKNESS OF BASE MATERIAL.
4. DIMENSIONS D AND E DO NOT INCLUDE MOLD FLASH, PROTRUSIONS, OR GATE BURRS.

DIM	MILLIMETERS			INCHES		
	MIN	NOM	MAX	MIN	NOM	MAX
A	0.89	1.00	1.11	0.035	0.040	0.044
A1	0.01	0.06	0.10	0.001	0.002	0.004
b	0.37	0.44	0.50	0.015	0.018	0.020
c	0.09	0.13	0.18	0.003	0.005	0.007
D	2.80	2.90	3.04	0.110	0.114	0.120
E	1.20	1.30	1.40	0.047	0.051	0.055
e	1.78	1.90	2.04	0.070	0.075	0.081
L	0.10	0.20	0.30	0.004	0.008	0.012
L1	0.35	0.54	0.69	0.014	0.021	0.029
HE	2.10	2.40	2.64	0.083	0.094	0.104
θ	0°	---	10°	0°	---	10°

STYLE 6:

1. BASE
2. EMITTER
3. COLLECTOR

### SOLDERING FOOTPRINT\*

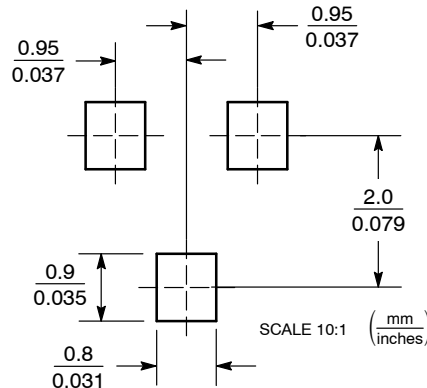

\*For additional information on our Pb-Free strategy and soldering details, please download the ON Semiconductor Soldering and Mounting Techniques Reference Manual, SOLDERRM/D.

ON Semiconductor and are registered trademarks of Semiconductor Components Industries, LLC (SCILLC). SCILLC reserves the right to make changes without further notice to any products herein. SCILLC makes no warranty, representation or guarantee regarding the suitability of its products for any particular purpose, nor does SCILLC assume any liability arising out of the application or use of any product or circuit, and specifically disclaims any and all liability, including without limitation special, consequential or incidental damages. "Typical" parameters which may be provided in SCILLC data sheets and/or specifications can and do vary in different applications and actual performance may vary over time. All operating parameters, including "Typicals" must be validated for each customer application by customer's technical experts. SCILLC does not convey any license under its patent rights nor the rights of others. SCILLC products are not designed, intended, or authorized for use as components in systems intended for surgical implant into the body, or other applications intended to support or sustain life, or for any other application in which the failure of the SCILLC product could create a situation where personal injury or death may occur. Should Buyer purchase or use SCILLC products for any such unintended or unauthorized application, Buyer shall indemnify and hold SCILLC and its officers, employees, subsidiaries, affiliates, and distributors harmless against all claims, costs, damages, and expenses, and reasonable attorney fees arising out of, directly or indirectly, any claim of personal injury or death associated with such unintended or unauthorized use, even if such claim alleges that SCILLC was negligent regarding the design or manufacture of the part. SCILLC is an Equal Opportunity/Affirmative Action Employer. This literature is subject to all applicable copyright laws and is not for resale in any manner.

### PUBLICATION ORDERING INFORMATION

**LITERATURE FULFILLMENT:**  
Literature Distribution Center for ON Semiconductor  
P.O. Box 5163, Denver, Colorado 80217 USA  
**Phone:** 303-675-2175 or 800-344-3860 Toll Free USA/Canada  
**Fax:** 303-675-2176 or 800-344-3867 Toll Free USA/Canada  
**Email:** orderlit@onsemi.com

**N. American Technical Support:** 800-282-9855 Toll Free  
USA/Canada  
**Europe, Middle East and Africa Technical Support:**  
Phone: 421 33 790 2910  
**Japan Customer Focus Center**  
Phone: 81-3-5817-1050

**ON Semiconductor Website:** [www.onsemi.com](http://www.onsemi.com)  
**Order Literature:** <http://www.onsemi.com/orderlit>  
For additional information, please contact your local Sales Representative