

PRODUCT NUMBER

71600-YXXLF

LEAD FREE, SEE NOTE 6

TOTAL NB OF POSITION 04 TO 64
SEE SHEET 2

OPTIONAL STRAIN RELIEF
SEE SHEET 2

TRIANGLE INDICATES
POSITION 1
NOTE 5

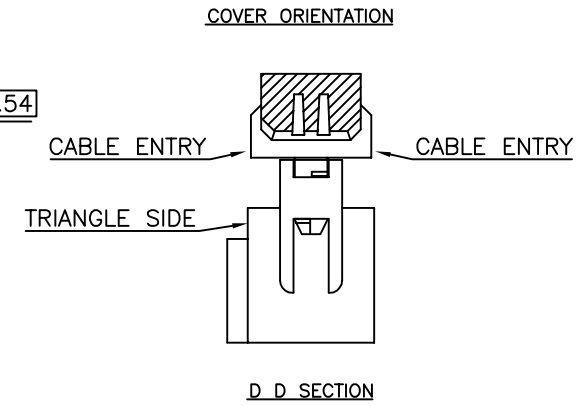
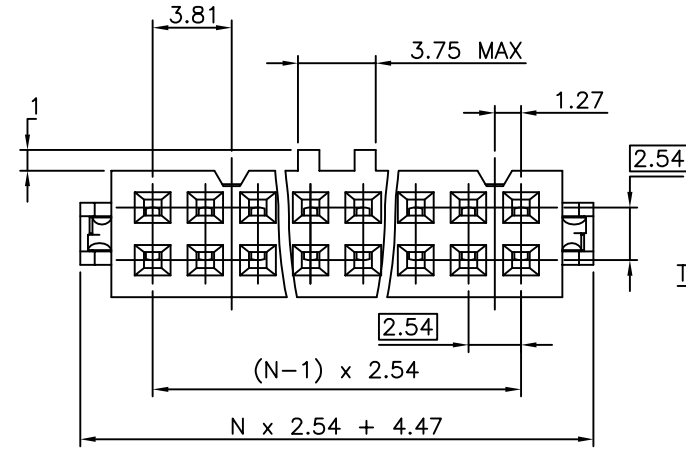
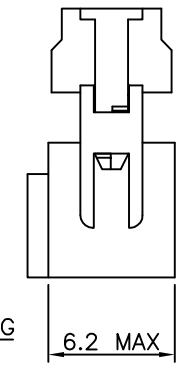
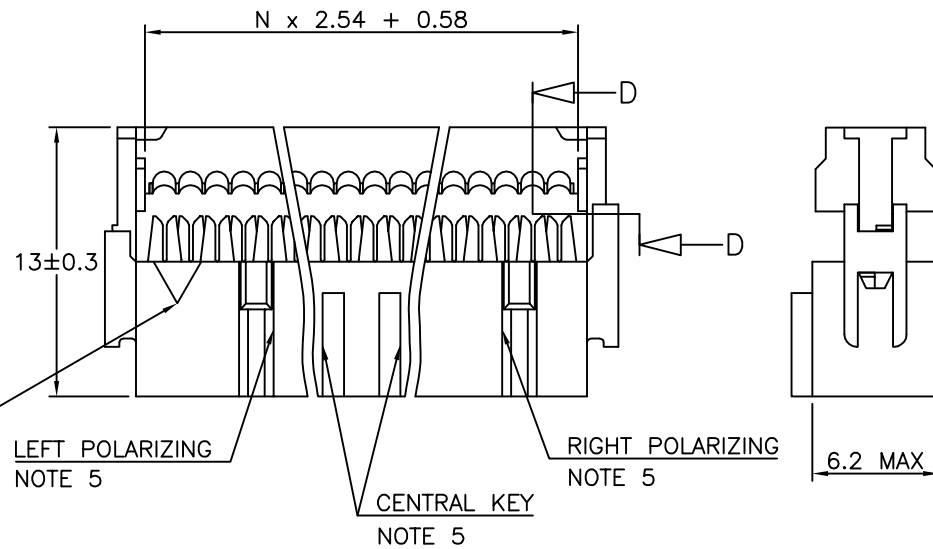

NOTES:

- 1 - PLASTIC MAT'L : GLASS FILLED HIGH TEMPERATURE THERMOPLASTIC. UL94V-0 COLOR: GREY
- 2 - PIN MATERIAL : PHOSPHOR BRONZE
- 3 - PRODUCT PACKAGED IN TUBES.
- 4 - TO DETERMINE DIMENSIONS :
N = NUMBER OF POSITIONS PER ROW
EXAMPLE : 8 POS N x 2.54 = 20.32mm
- 5 - 2x5, 2x6, 2x7 HAVE NO LEFT POLARIZING SLOT.
- 2x2, 2x3 WITH CENTRAL KEY HAVE NO TRIANGLE, NO LEFT AND RIGHT POLARIZING SLOT.
- 2x2 WITHOUT CENTRAL KEY HAS NO LEFT AND RIGHT POLARIZING SLOT.
- 2x3, 2x4 WITHOUT CENTRAL KEY HAVE NO LEFT POLARIZING SLOT
- 2x4 WITH CENTRAL KEY HAVE NO LEFT AND RIGHT POLARIZING SLOT
- 6 - THIS PRODUCT MEETS EUROPEAN UNION DIRECTIVES AND OTHER COUNTRY REGULATIONS AS PER GS-22-008.
PACKAGING SPECIFICATION AS PER GS-14-920.

mat'l. code SEE NOTES		surface ISO 1302	tolerance ISO 406 ISO 1101	projection	product family 2.54MM IDC
ltr	ecn no	dr	date	tolerances unless otherwise specified	title
AP	F12-0046	LMU	12.04.25	angles	QUICKIE III FEM
				linear	0.76µm Au
AJ	F05-0171	LMU	05.04.07		scale 5:1
AK	F05-0180	LMU	05.04.22	dr	D.LE
AL	F06-0270	LMU	06.09.12	engr	P.NZ
AM	F06-0274	LMU	06.09.25	chr	JF.N
AN	F09-0233	LMU	09.12.15	appd	P.NZ
sheet index	revision sheet	AP	AE		
	1	2			



dwg no 71600 sheet 1 of 2 size A3
type CUSTOMER Drawing

CORE RANGE	
STRAIN RELIEF	Nbr OF POSITIONS
0/1	04
0/1	06
0/1	08
0/1	10
0/1	14
0/1	16
0/1	18
0/1	20
0/1	24
0/1	26
0/1	30
0/1	34
0/1	40
0/1	50
0/1	60
0/1	64

PLATING	
0.76µm GOLD ON CONTACT AREA	
1.27 µm Ni REMAINDER OF PRODUCT	

CATALOGUE RANGE	
STRAIN RELIEF	Nbr OF POSITIONS
2/6	04
2/6	06
2/6	08
2/6	10
2/6	14
2/6	16
2/6	18
2/6	20
2/6	24
2/6	26
2/6	30
2/6	34
2/6	40
2/6	50
2/6	60
2/6	64

PLATING	
0.76µm GOLD ON CONTACT AREA	
1.27 µm Ni REMAINDER OF PRODUCT	

624
304
204 / 224
004
DASHES NOT AVAILABLE

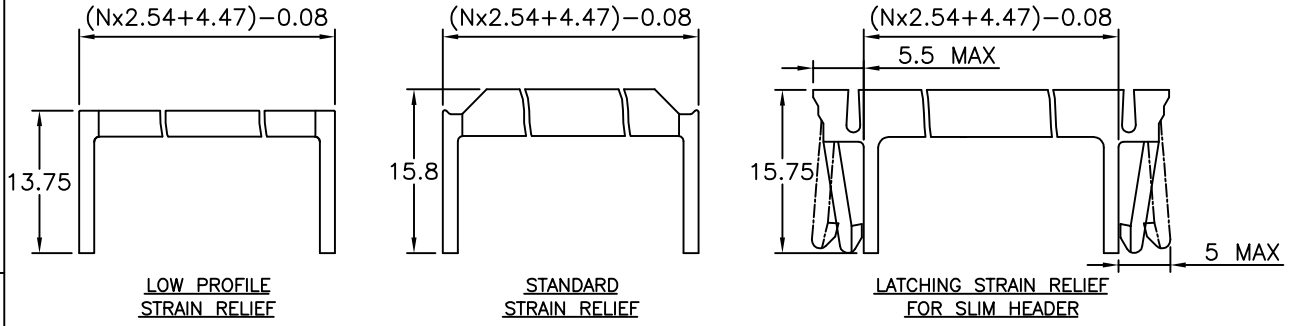
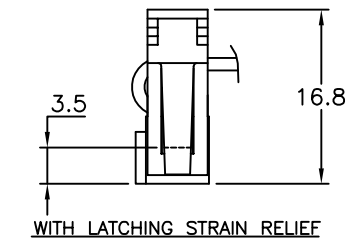
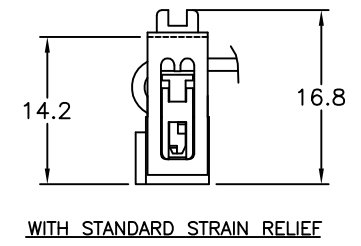
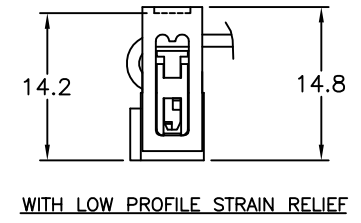
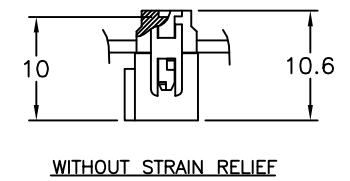

71600-6YYLF	●					●
71600-3YYLF		●	●			
71600-2YYLF	●				●	
71600-1YYLF	●			●		
71600-0YYLF	●		●			
PRODUCT NUMBER	WITH	WITHOUT	STANDARD	WITHOUT	LOW PROFILE	LATCHING
	CENTRAL KEY		STRAIN RELIEF			

mat'l. code		surface <input checked="" type="checkbox"/> ISO 1302		tolerance <input checked="" type="checkbox"/> ISO 406 <input type="checkbox"/> ISO 1101		projection		product family QUICKIE	
ltr	ecn no	dr	date	tolerances unless otherwise specified		mm		title IDC RECEPT DR	
X	F70666	AAN	97.11.05	angles	linear	scale N/A		dwg no 71600 sheet 2 of - size A3	
Y	F10121	DLE	01.01.24					type CUSTOMER Drawing	
AA	F10199	GCO	01.04.26						
AB	F03019	DLE	03.01.23	dr	D.LE	01.01.24			
AC	F05-0180	LMU	05.04.22	engr	P.NZ	01.01.24			
AD	F06-0270	LMU	06.09.12	chr	JF.N	01.01.24			
AE	F06-0274	LMU	06.09.25	appd	P.NZ	01.01.24			
sheet index	revision sheet								

FCI
 FCIconnect.com
 Copyright FCI