

MGA-43428

High Linearity 851 – 894 MHz Power Amplifier Module



Data Sheet

Description

Avago Technologies' MGA-43428 is a fully matched power amplifier for use in the (851-894) MHz band. High linear output power at 5V is achieved through the use of Avago Technologies' proprietary 0.25um GaAs Enhancement-mode pHEMT process. MGA-43428 is housed in a miniature 5.0mm x 5.0mm molded-chip-on-board (MCOB) module package. A detector is also included on-chip. The compact footprint coupled with high gain, high linearity and good efficiency makes the MGA-43428 an ideal choice as a power amplifier for small cell BTS PA applications.

Applications

- Final stage high linearity amplifier for Picocell and Enterprise Femtocell PA targeted for small cell BTS downlink applications.

Component Image

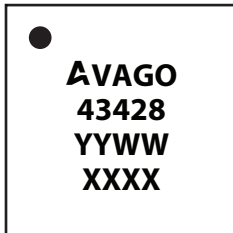

TOP VIEW

5.0 x 5.0 x 0.9 mm Package Outline

Note:
 Package marking provides orientation and identification
 "43428" = Device part number
 "YYWW" = year and work week
 "XXXX" = assembly lot number

Pin Configuration

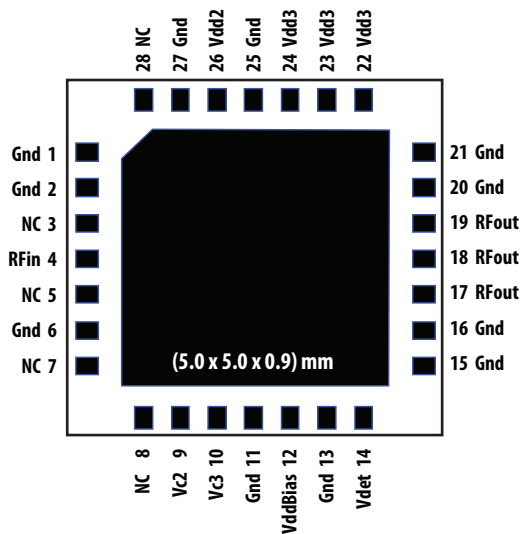

Features

- High linearity performance : Max -50dBc ACLR ^[1] at 27.2dBm linear output power (biased on 5V supply)
- High gain : 33.7dB
- Good efficiency
- Fully matched
- Built-in detector
- GaAs E-pHEMT Technology ^[2]
- Low cost small package size: (5.0 x 5.0 x 0.9) mm
- MSL3
- Lead free/Halogen free/RoHS compliance

Specifications

880MHz; 5.0V, Idqtotal = 350mA (typ), W-CDMA Test model #1, 64DPCH downlink signal

- PAE : 14.9%
- 27.2dBm linear Pout @ ACLR = -50dBc ^[1]
- 33.7dB Gain
- Detector range : 20dB

Note:

- W-CDMA Test model #1, 64DPCH downlink signal.
- Enhancement mode technology employs positive Vgs, thereby eliminating the need of negative gate voltage associated with conventional depletion mode devices.

Functional Block Diagram

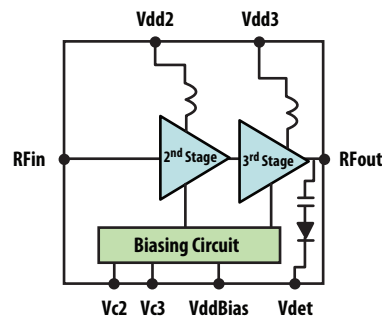

Attention: Observe precautions for handling electrostatic sensitive devices.

ESD Machine Model = 80 V
 ESD Human Body Model = 400 V
 Refer to Avago Application Note A004R:
 Electrostatic Discharge, Damage and Control.

Absolute Maximum Rating^[1] $T_A = 25^\circ\text{C}$

Symbol	Parameter	Units	Absolute Max.
Vdd, VddBias	Supply voltages, bias supply voltage	V	6
Vc	Control Voltage	V	(Vdd)
P _{in,max}	CW RF Input Power	dBm	20
P _{diss}	Total Power Dissipation ^[3]	W	4.9
T _j	Junction Temperature	°C	150
T _{STG}	Storage Temperature	°C	-65 to 150

Thermal Resistance^[2,3]

$\theta_{jc} = 13.5^\circ\text{C/W}$

Notes:

1. Operation of this device in excess of any of these limits may cause permanent damage.
2. Thermal resistance measured using Infra-Red Measurement Technique at Vdd = 5.5 V operating voltage.
3. Board temperature (TB) is 25 °C, for TB >83.8 °C derate the device power at 74mW per °C rise in Board (package belly) temperature.

Electrical Specifications

$T_A = 25^\circ\text{C}$, Vdd = VddBias = 5.0V, Vc2=Vc3=3V, Idqtotal = 350mA, RF performance at 880MHz, W-CDMA Test model #1, 64DPCH downlink signal operation unless otherwise stated.

Symbol	Parameter and Test Condition	Units	Min.	Typ.	Max.
Vdd	Supply Voltage	V	-	5.0	-
Idqtotal	Quiescent Supply Current	mA	-	350	560
Gain	Gain	dB	31	33.7	-
OP1dB	Output Power at 1dB Gain Compression	dBm	-	36.4	-
ACLR1 @ Pout = 27.2 dBm	W-CDMA Test model #1, 64DPCH downlink signal	dBc	-	-50	-
PAE @ Pout = 27.2 dBm	Power Added Efficiency	%	13	14.9	-
S11	Input Return Loss, 50 Ω source	dB	-	25	-
DetR	Detector RF dynamic range	dB	-	20	-

$T_A = 25^\circ\text{C}$, Vdd = VddBias=5.5V, Vc2=2.9V, Vc3=2.7V Idqtotal = 345mA, RF performance at 880MHz, W-CDMA Test model #1, 64DPCH downlink signal operation unless otherwise stated.

Symbol	Parameter and Test Condition	Units	Typ.
Vdd	Supply Voltage	V	5.5
Idqtotal	Quiescent Supply Current	mA	345
Gain	Gain	dB	33.7
OP1dB	Output Power at 1dB Gain Compression	dBm	37.0
ACLR1 @ Pout = 27.9 dBm	W-CDMA Test model #1, 64DPCH downlink signal	dBc	-50
PAE @ Pout = 27.9 dBm	Power Added Efficiency	%	15
S11	Input Return Loss, 50 Ω source	dB	25
DetR	Detector RF dynamic range	dB	20

Product Consistency Distribution Charts [1]

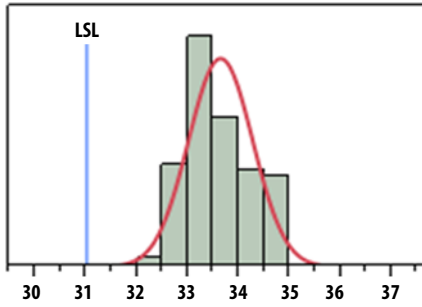

Figure 1. Gain at Pout=27.2dBm, LSL=31dB, nominal = 33.7dB

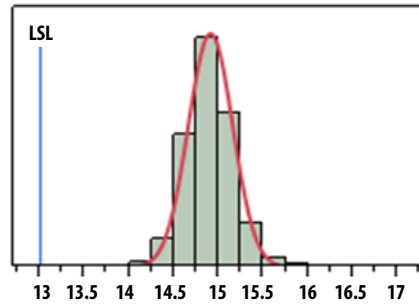

Figure 2. PAE at Pout=27.2dBm, LSL=13%, nominal = 14.9%

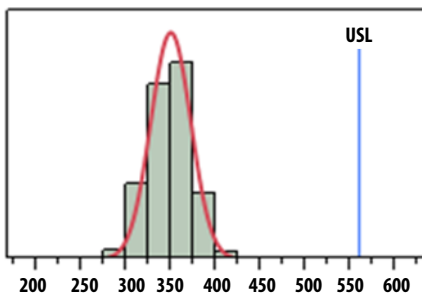

Figure 3. Idqtotal, Nominal = 350mA, USL=560mA

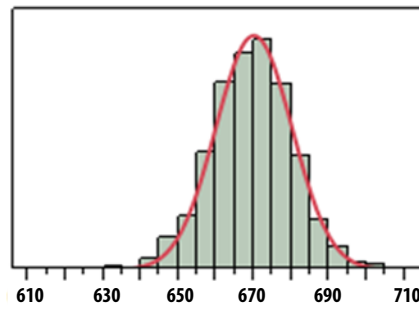

Figure 4. Idd_Total at Pout=27.2dBm, nominal = 670mA

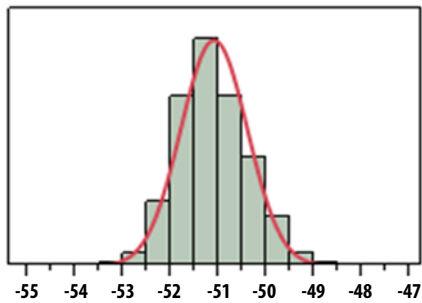

Figure 5. ACLR1 at Pout=27.2dBm, nominal = -51.1dBc

Note:

1. Distribution data sample size is 1500 samples taken from 3 different wafer lots. $T_A = 25^\circ\text{C}$, $V_{dd} = V_{ddBias} = 5.0\text{V}$, $V_{c2} = V_{c3} = 3\text{V}$, RF performance at 880MHz unless otherwise stated. Future wafers allocated to this product may have nominal values anywhere between the upper and lower limits.

MGA-43428 typical over-temperature performance at $V_{c2}=V_{c3}=3V$ ($V_{dd}=V_{ddBias}=5V$) as shown in Figure 35 and $V_{c2}=2.9V, V_{c3}=2.7V$ ($V_{dd}=V_{ddBias}=5.5V$) unless otherwise stated.

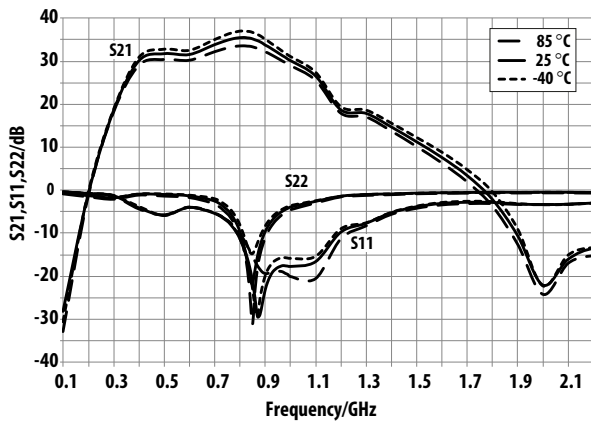

Figure 6. Small-signal performance Over-temperature $V_{dd}=V_{ddBias}=5.0V$ operating voltage

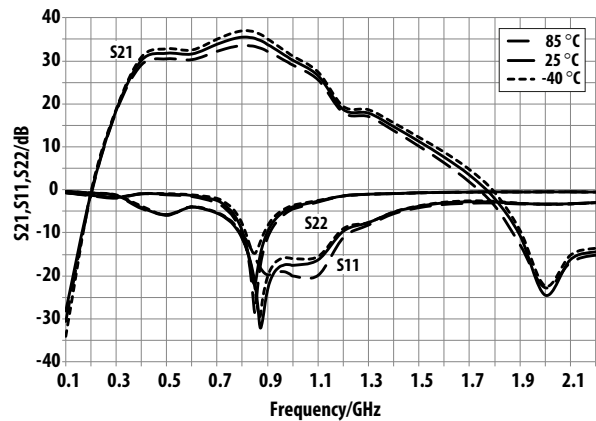

Figure 7. Small-signal performance Over-temperature $V_{dd}=V_{ddBias}=5.5V$ operating voltage

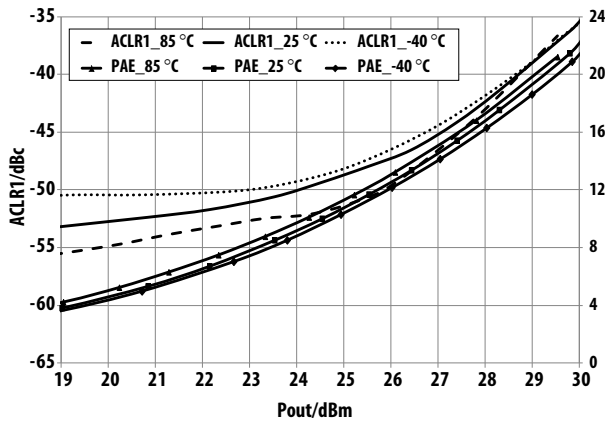

Figure 8. Over-temperature ACLR1, PAE vs Pout @ 851MHz $V_{dd}=V_{ddBias}=5.0V$ operating voltage

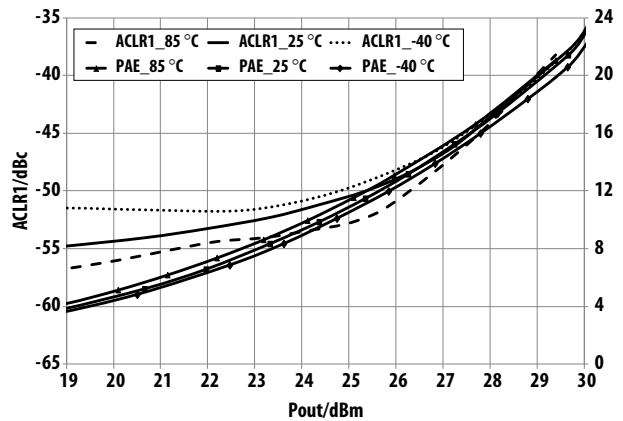

Figure 9. Over-temperature ACLR1, PAE vs Pout @ 859MHz $V_{dd}=V_{ddBias}=5V$ operating voltage

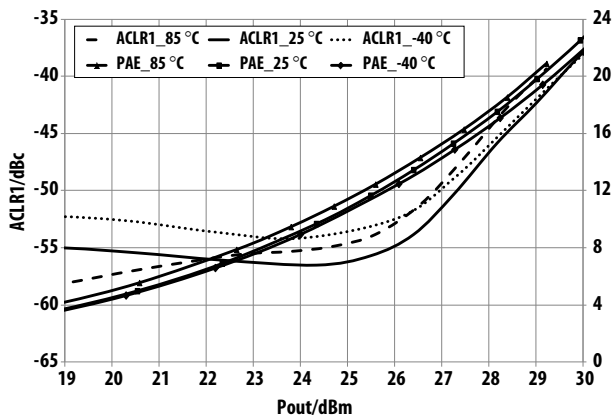

Figure 10. Over-temperature ACLR1, PAE vs Pout @ 869MHz $V_{dd}=V_{ddBias}=5.0V$ operating voltage

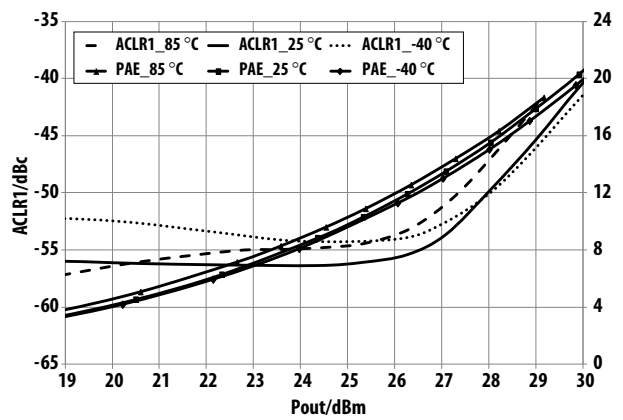

Figure 11. Over-temperature ACLR1, PAE vs Pout @ 869MHz $V_{dd}=V_{ddBias}=5.5V$ operating voltage

MGA-43428 typical over-temperature performance at $V_{c2}=V_{c3}=3V$ ($V_{dd}=V_{ddBias}=5V$) as shown in Figure 35 and $V_{c2}=2.9V, V_{c3}=2.7V$ ($V_{dd}=V_{ddBias}=5.5V$) unless otherwise stated.

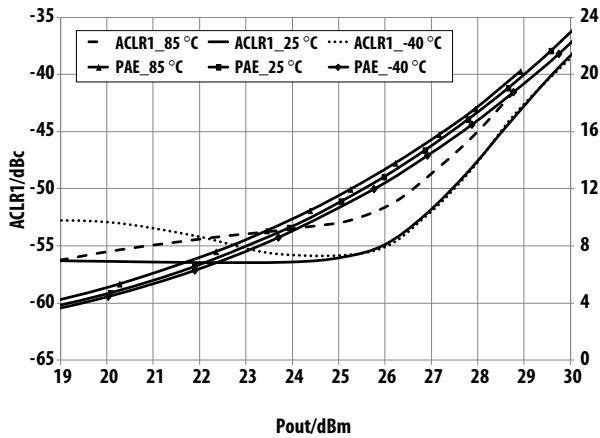

Figure 12. Over-temperature ACLR1, PAE vs Pout @ 880MHz $V_{dd}=V_{ddBias}=5.0V$ operating voltage

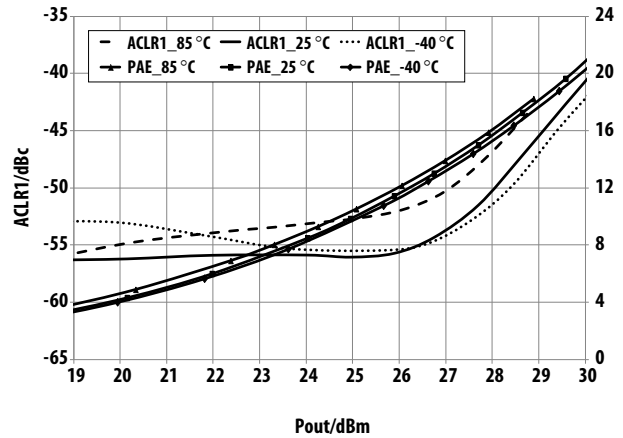

Figure 13. Over-temperature ACLR1, PAE vs Pout @ 880MHz $V_{dd}=V_{ddBias}=5.5V$ operating voltage

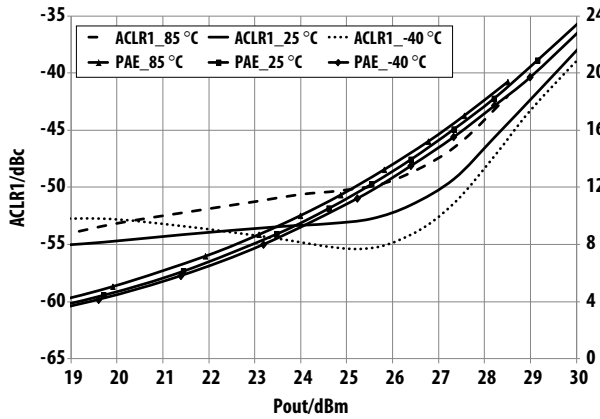

Figure 14. Over-temperature ACLR1, PAE vs Pout @ 894MHz $V_{dd}=V_{ddBias}=5.0V$ operating voltage

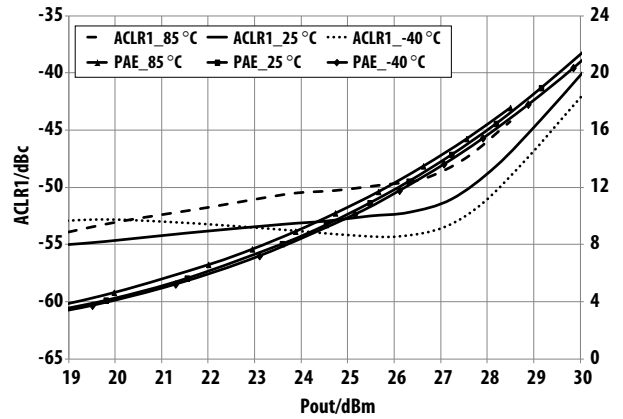

Figure 15. Over-temperature ACLR1, PAE vs Pout @ 894MHz $V_{dd}=V_{ddBias}=5.5V$ operating voltage

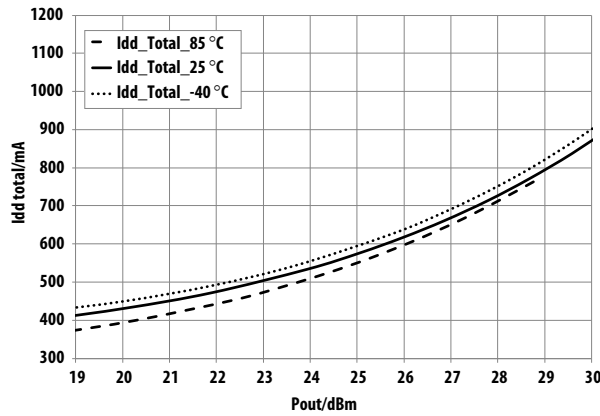

Figure 16. Over-temperature Idd_Total vs Pout @ 880MHz $V_{dd}=V_{ddBias}=5.0V$ operating voltage

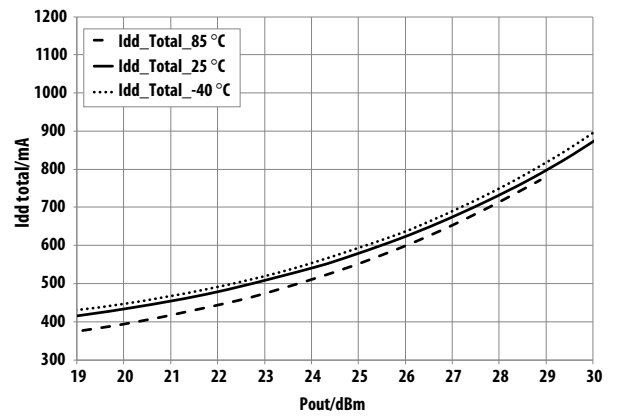

Figure 17. Over-temperature Idd_Total vs Pout @ 880MHz $V_{dd}=V_{ddBias}=5.5V$ operating voltage

MGA-43428 typical over-temperature performance at $V_{c2}=V_{c3}=3V$ ($V_{dd}=V_{ddBias}=5.0V$) as shown in Figure 35 and $V_{c2}=2.9V, V_{c3}=2.7V$ ($V_{dd}=V_{ddBias}=5.5V$) unless otherwise stated.

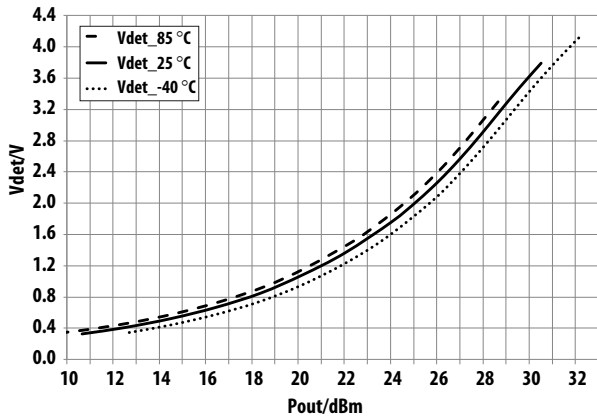

Figure 18. Over-temperature Vdet vs Pout @ 880MHz $V_{dd}=V_{ddBias}=5.0V$ operating voltage

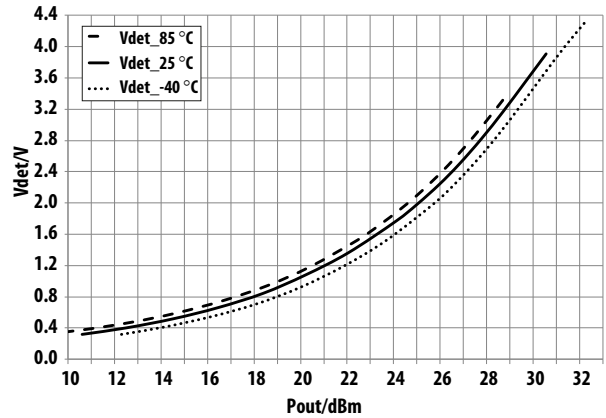

Figure 19. Over-temperature Vdet vs Pout @ 880MHz $V_{dd}=V_{ddBias}=5.5V$ operating voltage

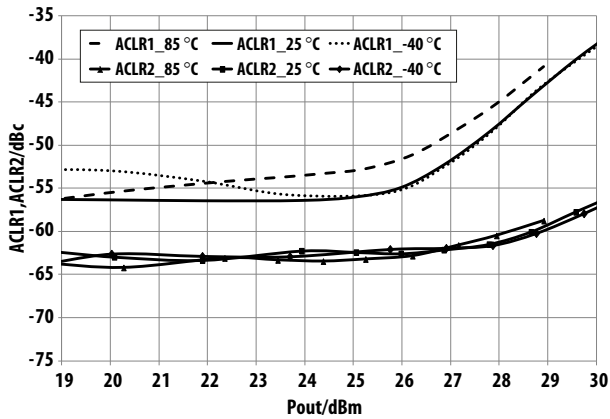

Figure 20. Over-temperature ACLR1, ACLR2/dBc vs Pout @ 880MHz $V_{dd}=V_{ddBias}=5.0V$ operating voltage

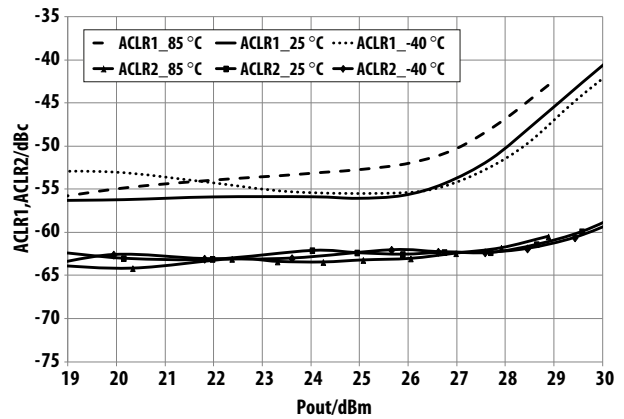

Figure 21. Over-temperature ACLR1, ACLR2/dBc vs Pout @ 880MHz $V_{dd}=V_{ddBias}=5.5V$ operating voltage

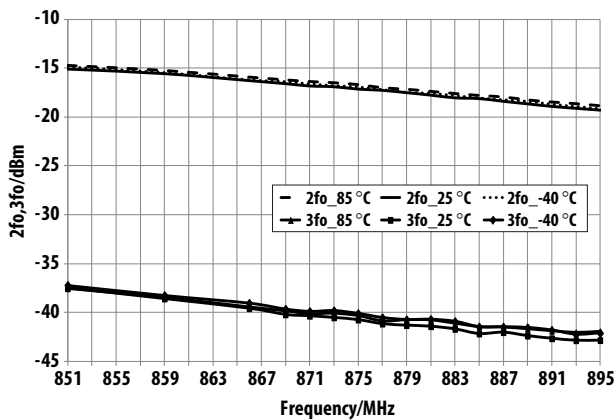

Figure 22. Over-temperature 2nd, 3rd Harmonics vs Freq at Pout=27.2dBm, $V_{dd}=V_{ddBias}=5.0V$ operating voltage

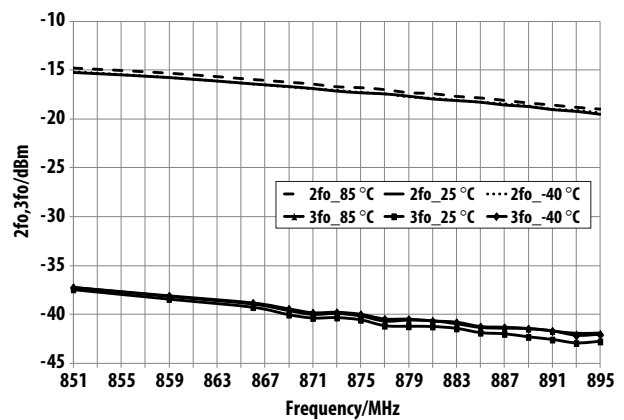

Figure 23. Over-temperature 2nd, 3rd Harmonics vs Freq at Pout=27.2dBm, $V_{dd}=V_{ddBias}=5.5V$ operating voltage

MGA-43428 typical over-temperature performance at $V_{c2}=V_{c3}=3V$ ($V_{dd}=V_{ddBias}=5V$) as shown in Figure 35 and $V_{c2}=2.9V, V_{c3}=2.7V$ ($V_{dd}=V_{ddBias}=5.5V$) unless otherwise stated.

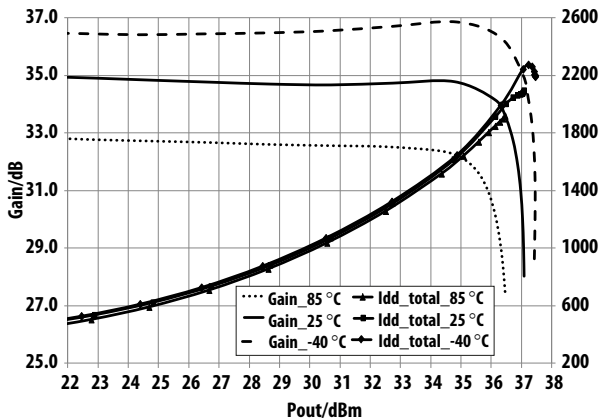

Figure 24. Over-temperature Gain, Idd_Total vs Pout @ 851MHz
 $V_{dd}=V_{ddBias}=5.0V$ operating voltage

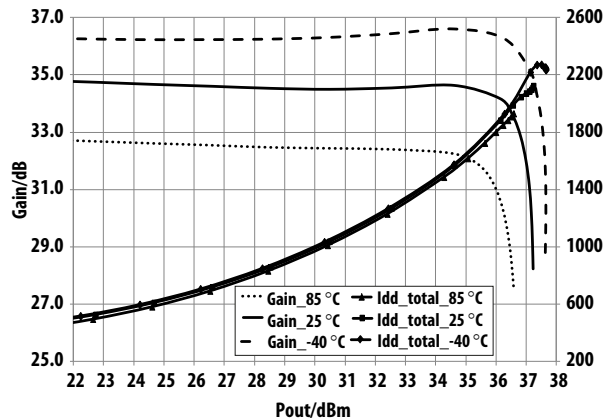

Figure 25. Over-temperature Gain, Idd_Total vs Pout @ 859MHz
 $V_{dd}=V_{ddBias}=5.0V$ voltage

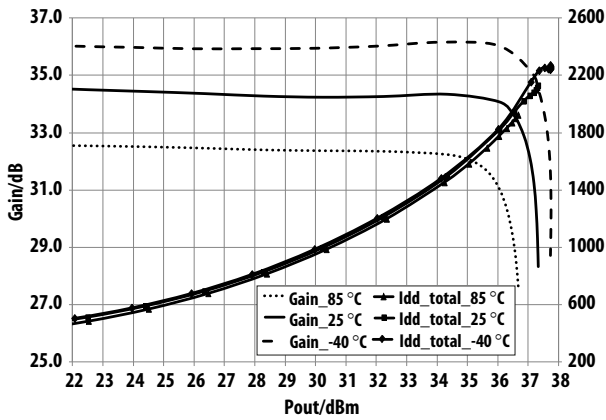

Figure 26. Over-temperature Gain, Idd_Total vs Pout @ 869MHz
 $V_{dd}=V_{ddBias}=5.0V$ operating voltage

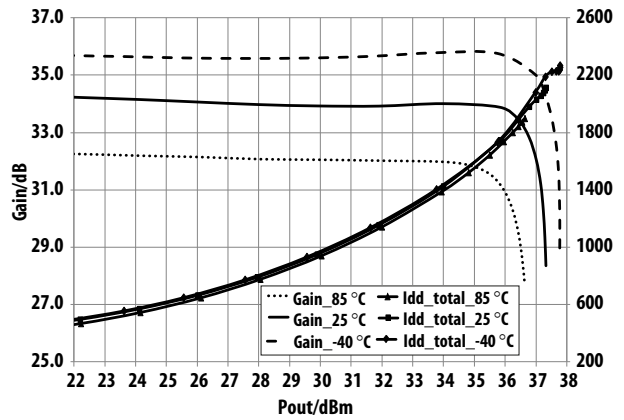

Figure 27. Over-temperature Gain, Idd_Total vs Pout @ 880MHz
 $V_{dd}=V_{ddBias}=5.0V$ voltage

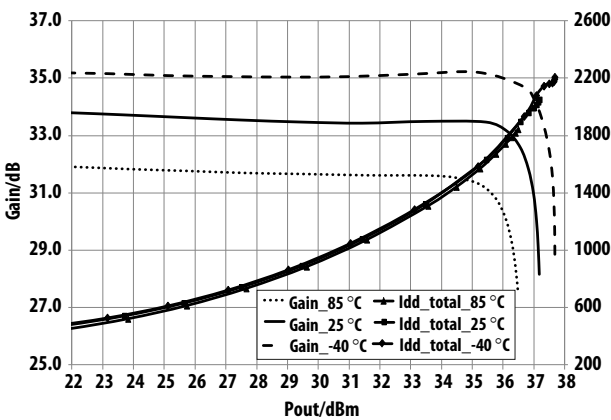

Figure 28. Over-temperature Gain, Idd_Total vs Pout @ 894MHz
 $V_{dd}=V_{ddBias}=5.0V$ operating voltage

MGA-43428 typical 3GPP W-CDMA Test model #1 Spectrum Emission Mask performance at Vdd=VddBias=5.0V, Vc2=Vc3=3V unless otherwise stated.

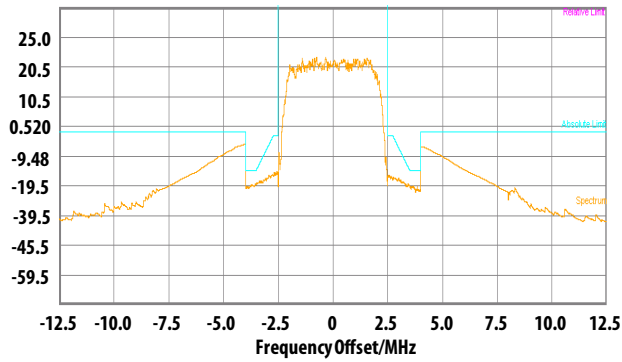

Figure 29. SEM at Pout=28dBm @ 851MHz

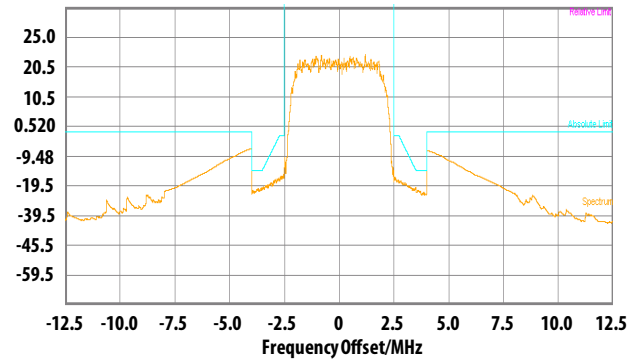

Figure 30. SEM at Pout=28dBm @ 859MHz

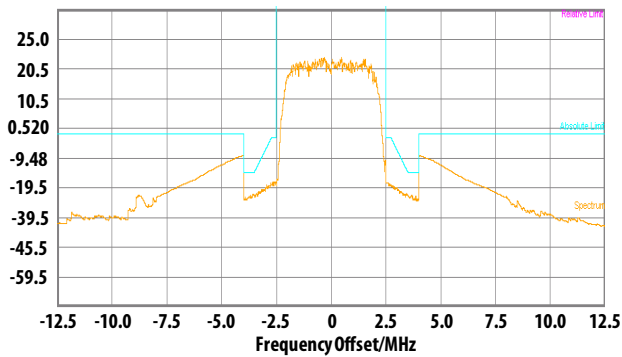

Figure 31. SEM at Pout=28dBm @ 869MHz

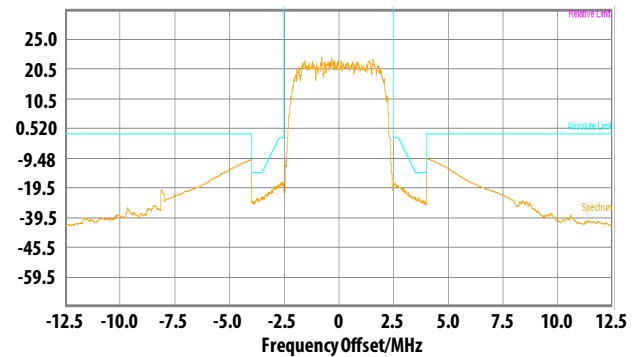

Figure 32. SEM at Pout=28dBm @ 880MHz

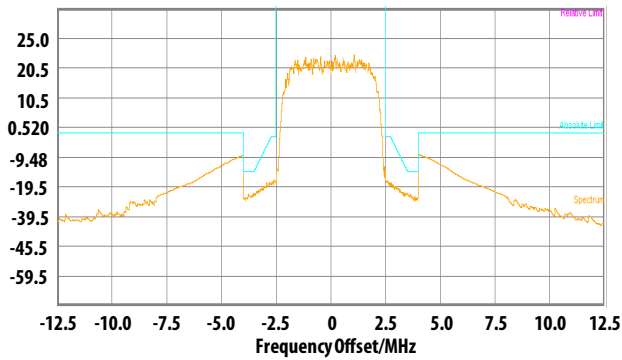

Figure 33. SEM at Pout=28dBm @ 894MHz

S-Parameter^[5] (Vdd=VddBias=5.0V, Vc2=Vc3=3V, TA=25 °C, 50ohm)

Freq	S11	S11	S21	S21	S12	S12	S22	S22
(GHz)	(dB)	(ang)	(dB)	(ang)	(dB)	(ang)	(dB)	(ang)
0.1	-0.279	163.713	-28.202	-21.616	-63.031	-63.949	-0.748	174.481
0.2	-0.462	144.704	-1.01	-61.828	-63.509	-121.03	-1.172	171.921
0.3	-0.847	114.595	17.853	-124.749	-79.206	-132.692	-1.461	173.548
0.4	-3.813	40.322	29.673	139.221	-65.466	-51.065	-0.637	170.986
0.5	-6.353	-105.622	31.19	44.592	-63.041	-112.889	-0.818	162.172
0.6	-3.764	-175.42	31.777	5.7	-57.981	-156.352	-0.88	155.194
0.70	-4.76	148.36	33.604	-44.016	-51.025	178.006	-1.968	136.005
0.75	-6.288	129.471	34.716	-70.21	-48.786	161.263	-3.67	120.258
0.76	-6.763	125.483	34.918	-75.948	-48.366	158.687	-4.22	116.371
0.77	-7.339	121.292	35.114	-81.952	-47.791	151.075	-4.906	111.915
0.78	-8.001	117.126	35.286	-88.131	-47.225	147.119	-5.734	107.047
0.79	-8.796	112.954	35.429	-94.496	-46.979	141.353	-6.727	101.727
0.80	-9.741	108.927	35.539	-101.032	-46.63	134.179	-7.933	95.81
0.81	-10.83	105.292	35.614	-107.702	-45.549	129.29	-9.429	89.08
0.82	-12.153	101.863	35.634	-114.496	-45.766	121.44	-11.386	80.772
0.83	-13.737	99.621	35.609	-121.38	-46.181	116.344	-13.877	69.025
0.84	-15.608	98.82	35.54	-128.276	-45.979	109.828	-17.087	49.51
0.85	-17.824	100.403	35.422	-135.133	-45.224	101.98	-20.429	16.245
0.86	-20.478	105.858	35.255	-141.912	-44.529	95.379	-21.19	-35.397
0.87	-23.096	120.412	35.035	-148.549	-45.07	90.014	-17.336	-67.009
0.88	-24.32	144.578	34.78	-155.023	-45.382	86.305	-14.306	-84.631
0.89	-23.832	167.094	34.491	-161.319	-45.459	80.565	-12.037	-95.432
0.90	-22.279	-177.303	34.171	-167.415	-45.402	74.488	-10.302	-102.979
0.91	-20.561	-170.127	33.823	-173.297	-45.396	72.391	-8.924	-109.046
0.92	-19.244	-167.627	33.451	-178.939	-45.905	66.811	-7.864	-113.892
0.93	-18.252	-166.43	33.074	175.672	-45.84	64.594	-6.996	-118.083
0.94	-17.533	-166.226	32.691	170.464	-45.894	59.934	-6.266	-121.89
0.95	-17.021	-166.597	32.299	165.435	-46.183	53.987	-5.651	-125.334
0.96	-16.655	-167.016	31.893	160.607	-46.477	51.213	-5.139	-128.326
0.97	-16.434	-167.132	31.502	155.928	-46.507	42.658	-4.705	-131.01
0.98	-16.369	-167.175	31.106	151.415	-46.475	41.817	-4.333	-133.457
0.99	-16.39	-167.015	30.713	147.009	-46.787	41.403	-4.01	-135.701
1.0	-16.836	-165.927	30.35	142.87	-47.117	39.826	-3.775	-137.292
1.1	-16.787	-123.059	26.778	103.521	-48.588	4.326	-2.322	-150.146
1.2	-9.819	-126.66	19.659	68.37	-53.365	-29.741	-1.188	-154.668
1.3	-7.267	-125.881	18.231	53.823	-53.431	-32.282	-0.737	-163.55
1.4	-4.808	-136.026	14.993	28.337	-54.615	-57.338	-0.553	-168.2
1.5	-3.381	-147.083	11.549	5.48	-56.792	-54.424	-0.422	-171.185
1.6	-2.589	-157.355	8.124	-16.899	-59.051	-79.166	-0.194	-174.217
1.7	-2.235	-166.689	4.221	-40.731	-63.931	-92.696	-0.185	-177.218

S-Parameter^[5] (Vdd=VddBias=5.0V, Vc2=Vc3=3V, TA=25 °C, 50ohm) Continued

Freq	S11	S11	S21	S21	S12	S12	S22	S22
(GHz)	(dB)	(ang)	(dB)	(ang)	(dB)	(ang)	(dB)	(ang)
1.8	-2.282	-174.564	-0.751	-65.616	-69.219	-91.567	-0.208	-179.247
1.9	-2.582	-179.634	-8.178	-88.022	-64.601	92.695	-0.198	179.406
2.0	-2.757	178.106	-21.965	-70.735	-64.369	14.153	-0.119	177.883
2.1	-2.669	176.392	-17.748	6.253	-65.617	79.033	-0.112	176.235
2.2	-2.458	174.164	-14.874	-2.106	-65.682	-47.983	-0.118	174.931
2.3	-2.251	171.2	-14.688	-15.524	-69.286	47.691	-0.11	173.746
2.4	-2.109	167.967	-15.533	-29.596	-67.105	-173.868	-0.077	172.506
2.5	-2.053	164.605	-17.077	-44.476	-69.846	72.07	-0.062	171.142
2.6	-2.104	161.476	-19.799	-62.06	-65.351	-126.523	-0.095	169.817
2.7	-2.276	159.689	-26.062	-80.022	-71.683	-152.203	-0.14	168.728
2.8	-2.162	159.831	-30.924	10.411	-73.062	110.648	-0.129	167.958
2.9	-1.68	157.912	-23.025	-1.993	-65.882	100.057	-0.063	166.791
3.0	-1.397	154.167	-21.821	-18.25	-64.199	36.793	-0.09	165.216
3.5	-1.164	137.153	-17.47	-103.818	-69.85	46.932	-0.1	159.674
4.0	-1.288	122.791	-29.151	73.457	-62.117	92.479	-0.143	153.672
4.5	-1.534	109.313	-38.499	24.405	-70.059	62.88	-0.127	147.428
5.0	-1.814	99.01	-41.898	-11.621	-64.041	23.512	-0.161	140.379
5.5	-1.835	91.189	-46.309	-38.949	-68.856	47.119	-0.166	134.306
6.0	-1.749	81.178	-54.485	-36.192	-66.832	29.174	-0.2	127.319
7.0	-1.435	62.172	-49.891	13.721	-74.107	-28.35	-0.268	113.34
8.0	-1.369	41.12	-43.968	-24.325	-68.592	-20.144	-1.14	94.776
9.0	-2.048	8.852	-28.906	-154.272	-47.076	-160.962	-10.112	109.804
10.0	-3.801	-25.311	-45.49	120.099	-50.085	74.482	-1.003	47.132
11.0	-3.308	-57.449	-43.674	-14.743	-45.763	19.486	-1.497	-3.019
12.0	-2.966	-105.22	-46.11	-100.306	-43.048	-34.07	-2.188	-57.299
13.0	-4.892	-158.802	-45.46	77.676	-55.304	-92.766	-4.392	-93.561
14.0	-10.148	31.119	-39.937	-34.287	-46.152	-37.767	-1.789	-121.928
15.0	-5.004	-132.258	-40.974	-98.027	-39.762	-109.061	-1.151	-162.806
16.0	-2.471	165.237	-45.503	-142.428	-44.893	-161.603	-0.833	171.414
17.0	-1.547	146.582	-41.172	-160.839	-42.663	-162.441	-1.362	145.508
18.0	-1.616	112.011	-44.76	122.642	-44.824	119.407	-4.375	70.222
19.0	-2.206	78.724	-59.163	22.859	-54.654	50.726	-3.611	-38.084
20.0	-2.549	52.466	-50.574	120.932	-48.794	110.88	-3.061	-100.732

S-Parameter^[5] (Vdd=VddBias=5.5V, Vc2=2.9V, Vc3=2.7V, TA=25 °C, 50ohm)

Freq	S11	S11	S21	S21	S12	S12	S22	S22
(GHz)	(dB)	(ang)	(dB)	(ang)	(dB)	(ang)	(dB)	(ang)
0.1	-0.286	163.587	-28.113	-20.473	-59.949	124.392	-0.764	174.406
0.2	-0.465	144.74	-0.954	-60.978	-72.397	143.991	-1.201	171.792
0.3	-0.852	114.587	17.985	-124.557	-70.615	-59.588	-1.506	173.659
0.4	-3.81	40.462	29.736	138.709	-63.075	-5.667	-0.644	171.064
0.5	-6.333	-105.35	31.199	44.086	-58.997	-149.366	-0.842	162.243
0.6	-3.747	-175.157	31.77	5.281	-55.079	-147.417	-0.913	155.328
0.70	-4.752	148.707	33.561	-44.539	-50.92	177.275	-2.04	136.354
0.75	-6.262	130.173	34.639	-70.706	-48.526	155.844	-3.785	121.029
0.76	-6.745	126.145	34.834	-76.43	-47.924	154.719	-4.345	117.267
0.77	-7.297	122.137	35.026	-82.402	-47.162	146.629	-5.042	113.067
0.78	-7.957	118.09	35.19	-88.535	-47.265	144.931	-5.867	108.432
0.79	-8.743	114.122	35.326	-94.847	-46.736	140.178	-6.867	103.394
0.80	-9.659	110.345	35.433	-101.326	-45.772	131.728	-8.099	97.832
0.81	-10.701	106.869	35.505	-107.934	-45.359	124.52	-9.64	91.528
0.82	-12.004	103.81	35.522	-114.66	-46.047	124.202	-11.645	83.853
0.83	-13.518	101.689	35.494	-121.48	-46.159	114.997	-14.301	73.481
0.84	-15.277	101.048	35.425	-128.302	-45.533	107.384	-17.882	55.435
0.85	-17.332	102.713	35.312	-135.082	-44.982	103.656	-21.844	20.215
0.86	-19.743	107.781	35.147	-141.803	-45.587	100.985	-22.734	-41.021
0.87	-21.994	120.516	34.933	-148.379	-45.245	92.519	-18.069	-72.179
0.88	-23.38	140.646	34.684	-154.773	-45.448	84.093	-14.697	-88.553
0.89	-23.249	160.564	34.402	-161.028	-45.609	79.511	-12.303	-98.361
0.90	-21.997	176.014	34.09	-167.105	-45.602	76.916	-10.524	-105.294
0.91	-20.56	-175.193	33.75	-172.934	-45.575	71.343	-9.117	-110.743
0.92	-19.322	-171.735	33.39	-178.576	-45.468	65.167	-8.024	-115.281
0.93	-18.389	-169.954	33.02	176.049	-45.427	62.522	-7.131	-119.253
0.94	-17.692	-169.259	32.643	170.862	-45.449	59.112	-6.387	-122.873
0.95	-17.181	-169.17	32.256	165.842	-45.719	54.312	-5.764	-126.15
0.96	-16.813	-169.225	31.86	160.993	-46.491	49.458	-5.238	-129.005
0.97	-16.614	-169.18	31.473	156.308	-46.529	43.464	-4.801	-131.602
0.98	-16.544	-169.187	31.083	151.795	-46.174	40.697	-4.422	-133.965
0.99	-16.567	-168.844	30.696	147.381	-46.449	38.713	-4.089	-136.141
1.0	-17.035	-167.585	30.336	143.218	-46.977	36.093	-3.842	-137.678
1.1	-17.075	-122.526	26.798	103.645	-48.729	5.626	-2.362	-150.208
1.2	-9.913	-126.184	19.671	68.526	-53.615	-32.039	-1.2	-154.678
1.3	-7.305	-125.412	18.279	53.652	-52.97	-36.668	-0.748	-163.544
1.4	-4.826	-135.822	15.026	27.891	-54.817	-59.095	-0.558	-168.195
1.5	-3.399	-146.974	11.554	4.822	-56.408	-75.543	-0.424	-171.164
1.6	-2.615	-157.241	8.082	-17.645	-61.14	-92.315	-0.193	-174.207
1.7	-2.269	-166.539	4.121	-41.437	-63.405	-145.986	-0.182	-177.204
1.8	-2.308	-174.296	-0.908	-66.026	-66.51	-130.127	-0.205	-179.259
1.9	-2.584	-179.354	-8.352	-87.931	-73.06	173.723	-0.206	179.382

S-Parameter^[5] (Vdd=VddBias=5.5V, Vc2=2.9V, Vc3=2.7V, TA=25 °C, 50ohm) Continued

Freq	S11	S11	S21	S21	S12	S12	S22	S22
(GHz)	(dB)	(ang)	(dB)	(ang)	(dB)	(ang)	(dB)	(ang)
2.0	-2.761	178.271	-22.039	-69.716	-65.774	151.339	-0.121	177.893
2.1	-2.663	176.54	-17.819	6.795	-63.97	-13.319	-0.113	176.222
2.2	-2.464	174.227	-14.889	-1.559	-67.191	104.434	-0.119	174.928
2.3	-2.251	171.314	-14.697	-15.111	-66.77	-106.52	-0.111	173.744
2.4	-2.104	168.054	-15.546	-29.015	-68.601	-19.953	-0.077	172.53
2.5	-2.047	164.65	-17.094	-44.425	-62.938	-9.8	-0.064	171.132
2.6	-2.092	161.602	-19.729	-61.989	-72.969	-143.209	-0.094	169.813
2.7	-2.258	159.742	-26.149	-79.872	-71.475	65.475	-0.135	168.749
2.8	-2.145	159.798	-30.83	10.899	-72.344	120.391	-0.126	167.924
2.9	-1.681	157.858	-22.97	-1.781	-73.269	131.105	-0.059	166.765
3.0	-1.395	154.134	-21.785	-18.675	-62.432	106.999	-0.095	165.205
3.5	-1.159	137.132	-17.429	-104.237	-67.221	44.106	-0.094	159.67
4.0	-1.288	122.79	-29.08	73.168	-62.342	67.886	-0.148	153.651
4.5	-1.527	109.297	-38.443	21.915	-64.339	63.746	-0.128	147.402
5.0	-1.803	98.976	-42.087	-12.946	-68.747	-12.26	-0.162	140.367
5.5	-1.821	91.127	-46.559	-42.386	-64.34	28.7	-0.173	134.291
6.0	-1.744	81.077	-53.972	-39.128	-67.047	9.154	-0.198	127.323
7.0	-1.44	62.029	-50.315	13.331	-64.987	-8.73	-0.271	113.315
8.0	-1.38	41.054	-43.776	-23.713	-68.971	6.022	-1.142	94.756
9.0	-2.061	8.775	-28.893	-155.39	-47.692	-159.637	-10.044	109.905
10.0	-3.817	-25.346	-46.107	116.46	-51.239	74.057	-1.006	47.044
11.0	-3.305	-57.386	-43.697	-11.253	-45.56	19.399	-1.499	-3.149
12.0	-2.955	-105.162	-45.718	-108.798	-42.729	-35.532	-2.193	-57.433
13.0	-4.867	-158.812	-44.919	75.339	-52.813	-85.386	-4.396	-93.647
14.0	-10.184	30.467	-39.941	-33.914	-46.323	-32.018	-1.793	-122.102
15.0	-5.008	-132.666	-41.079	-100.137	-39.888	-107.586	-1.155	-162.923
16.0	-2.467	165.054	-45.916	-140.817	-45.06	-165.069	-0.838	171.323
17.0	-1.544	146.276	-41.593	-160.555	-42.588	-158.639	-1.378	145.37
18.0	-1.619	111.824	-44.741	119.814	-45.26	119.527	-4.408	69.888
19.0	-2.211	78.503	-58.683	56.644	-54.262	31.438	-3.612	-38.577
20.0	-2.547	52.28	-49.019	110.908	-50.645	116.823	-3.059	-101.004

Notes:

5. S-parameter is measured with deembedded reference plane at DUT RFin and RFout pins.

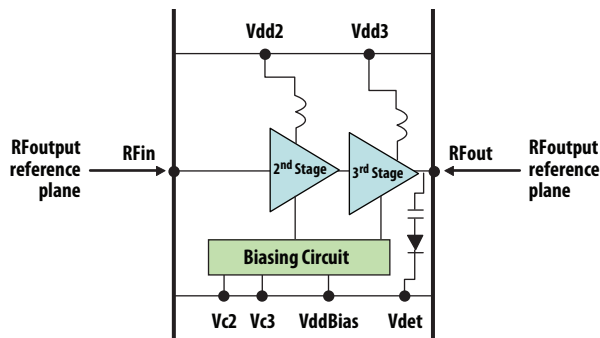
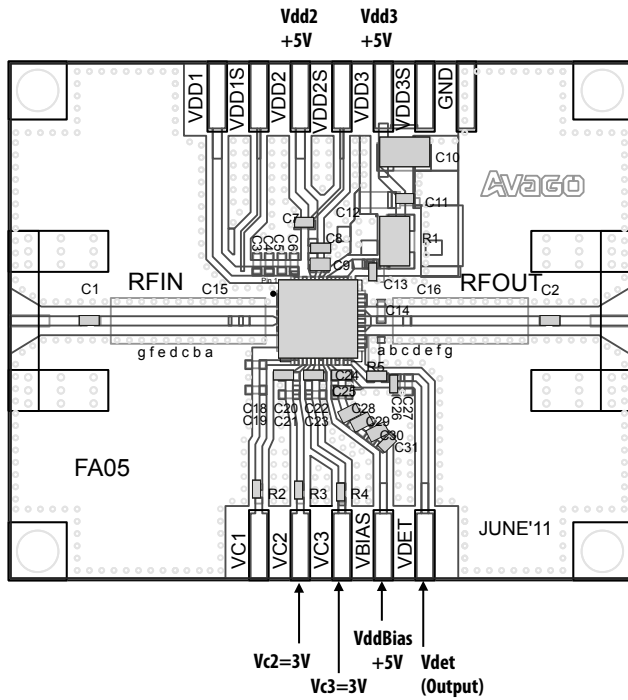

Figure 34. RFininput and RFoutput Reference Plane

Demonstration Board Top View

(Vdd=VddBias=5.0V, Vc2= Vc3=3V; Vdd=VddBias=5.5V operating voltage, Vc2=2.9V, Vc3=2.7V)



Component	Value	Supplier	Size
C1, C2, C20, C22	56pF ± 5%	Murata	0402
C11, C31	0.1uF ± 10%	Murata	0402
C3, C4, C5, C6, C12, C14, C18, C19, C21, C23, C27	Not Used	Murata	0402
C10	2.2uF ± 10%	Murata	0805
C26	22nF ± 10%	Kyocera	0402
R1	0Ω	KOA	0805
R3, R4, R5	0Ω	KOA	0402
C24	3.9pF ± 0.025	Murata	0402
C25	22pF ± 5%	Murata	0402
C28	82pF JA01	Murata	0402
C8, C29	2200pF JA01	Murata	0402
C7, C13, C30	0.047uF ± 5%	Murata	0402
C9	12pF ± 5%	Murata	0402

Note:

For performance optimization control voltage for individual stages can be adjusted by varying R2, R3 and R4 resistor value.

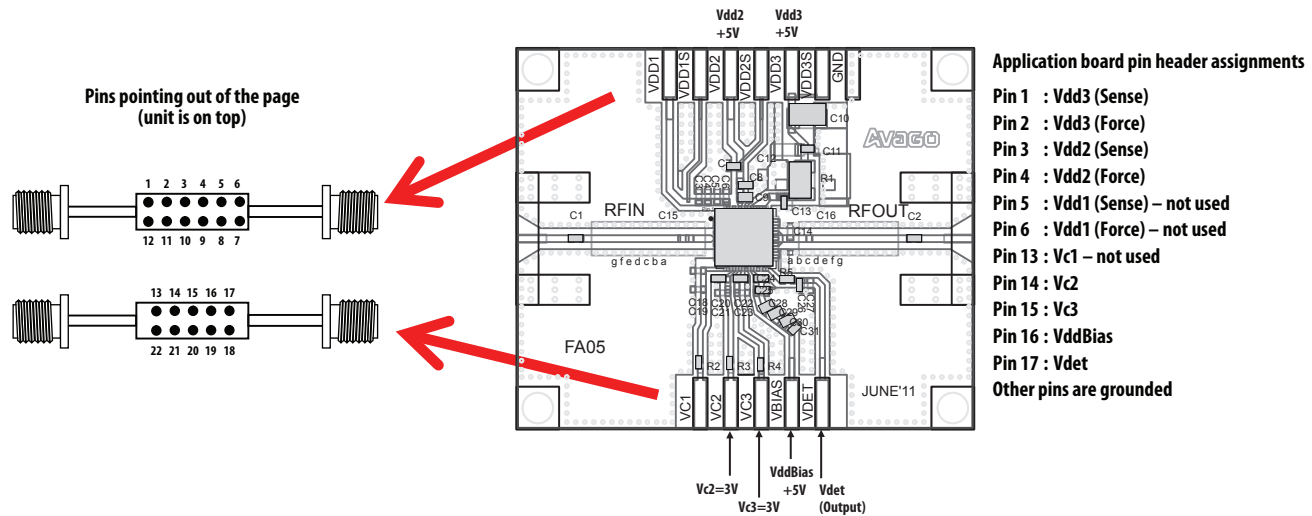

Figure 35. Demonstration board application circuit for MGA-43428 module

Application Schematic

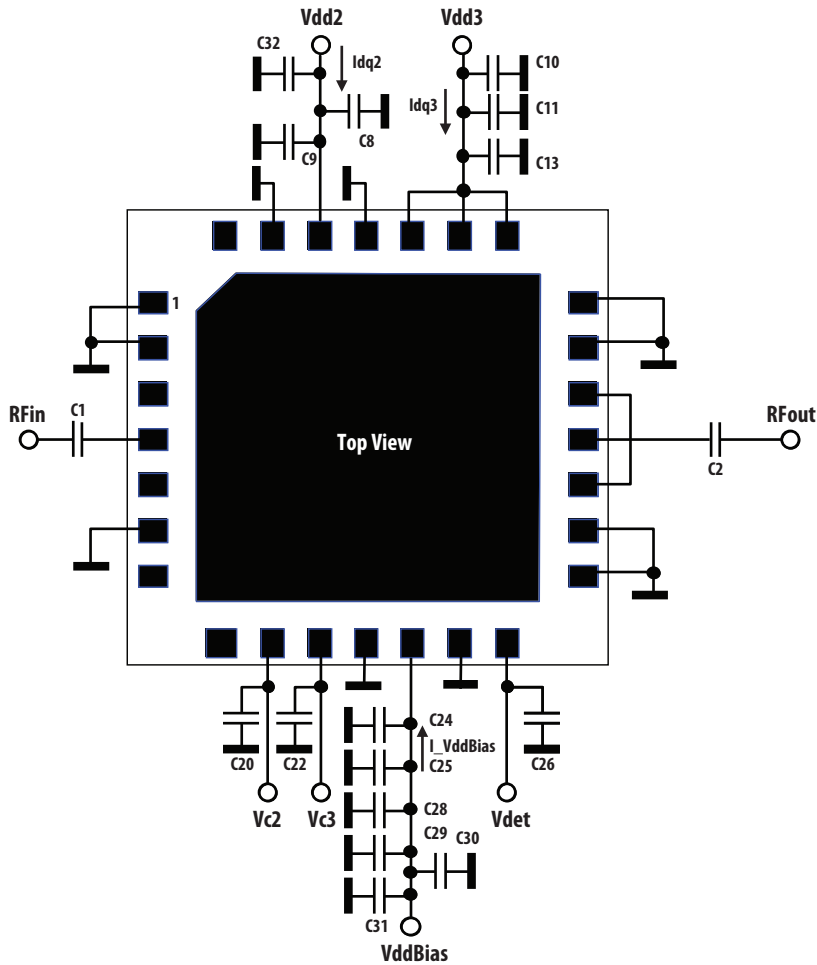

Figure 36. Application schematic in demonstration board

Notes

1. All capacitors on supply lines are bypass capacitors
2. C1 / C2 are RF coupling capacitors.
3. For Vdd=VddBias=5V, Idq2 = 100 mA, Idq3 = 250 mA, I_VddBias = 14 mA. Idq 2/3 are adjusted by voltages to CMOS-compatible control pins Vc 2/3 respectively. These typical bias currents were obtained with Vc 2/3 voltages in Fig 2 below. Adjustment of these currents enable optimum bias conditions to be achieved for best linearity and efficiency for a given modulation type.
4. For Vdd=VddBias=5.5V, Vc2 = 2.9V and Vc3 = 2.7V with typical Idq2 = 100 mA, Idq3 = 245 mA, I_VddBias = 14 mA

MGA-43428 typical I_{c2} , I_{c3} Vs V_c performance unless otherwise stated

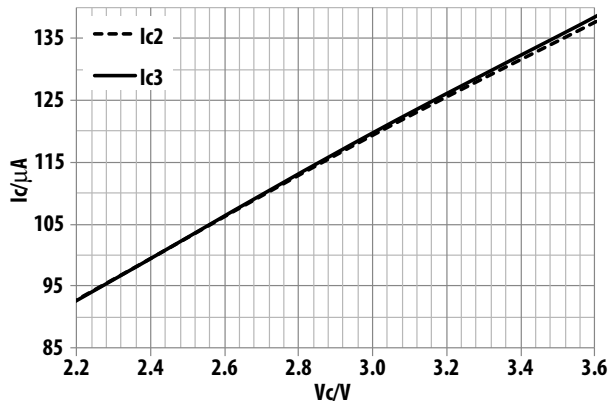

Figure 37. I_c Versus V_c at $V_{dd}=V_{dd}Bias=5.0V$

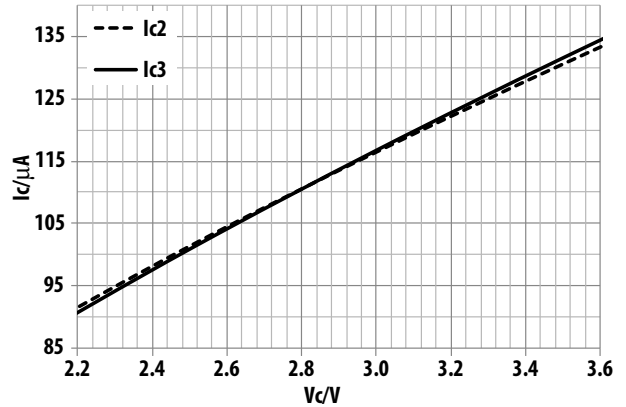
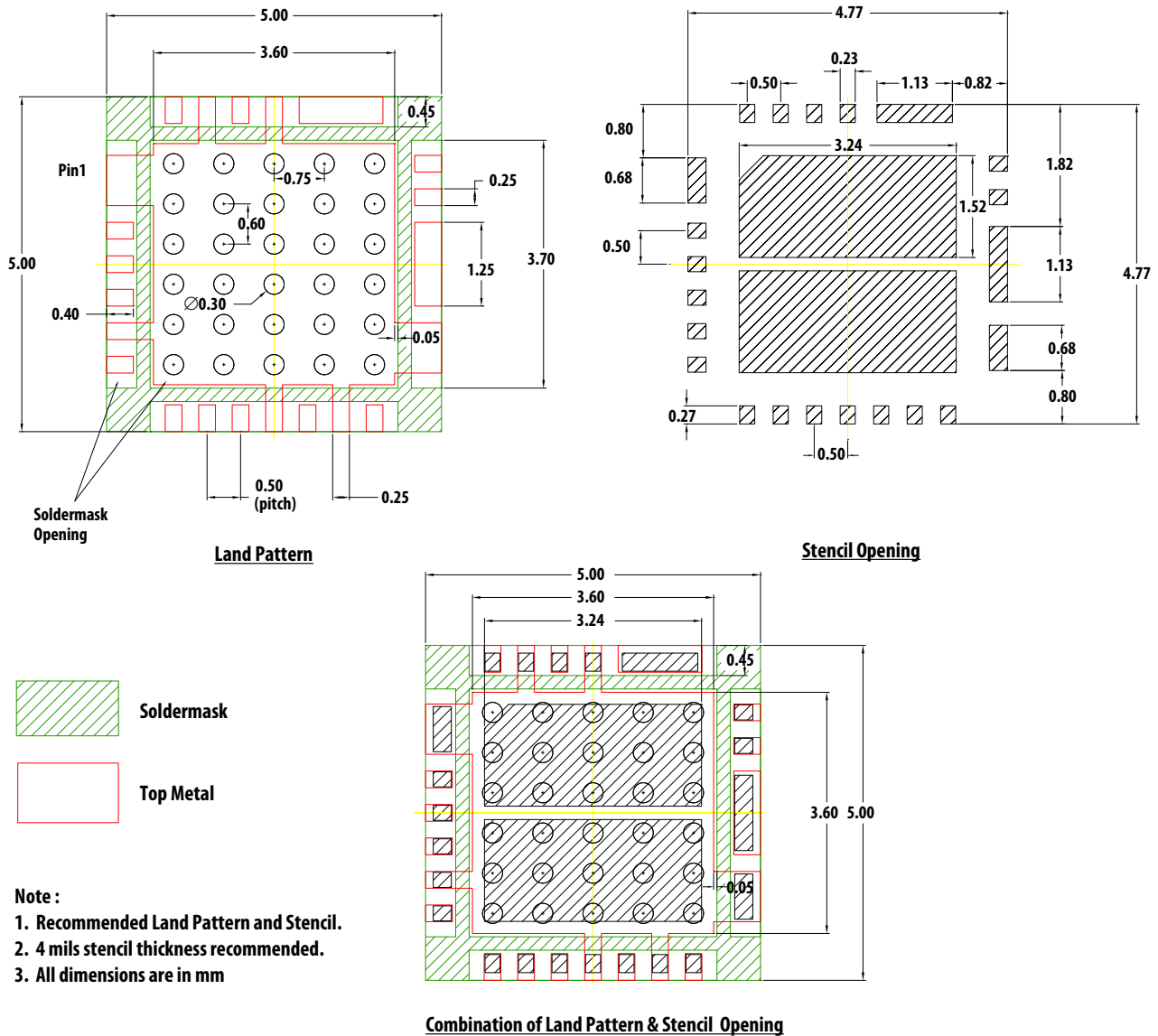
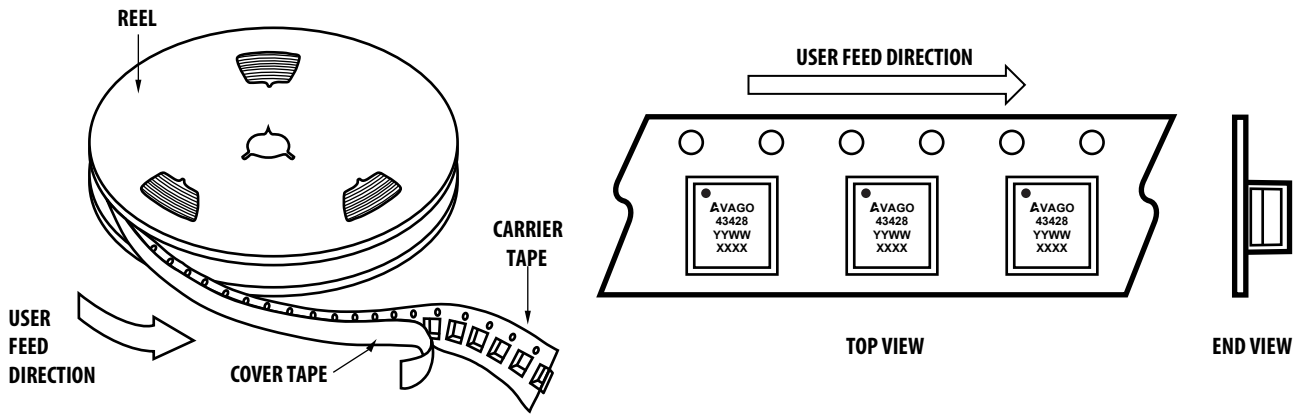

Figure 38. I_c Versus V_c at $V_{dd}=V_{dd}Bias=5.5V$

PCB Land Pattern and Stencil Outline



Device Orientation



Tape Dimensions

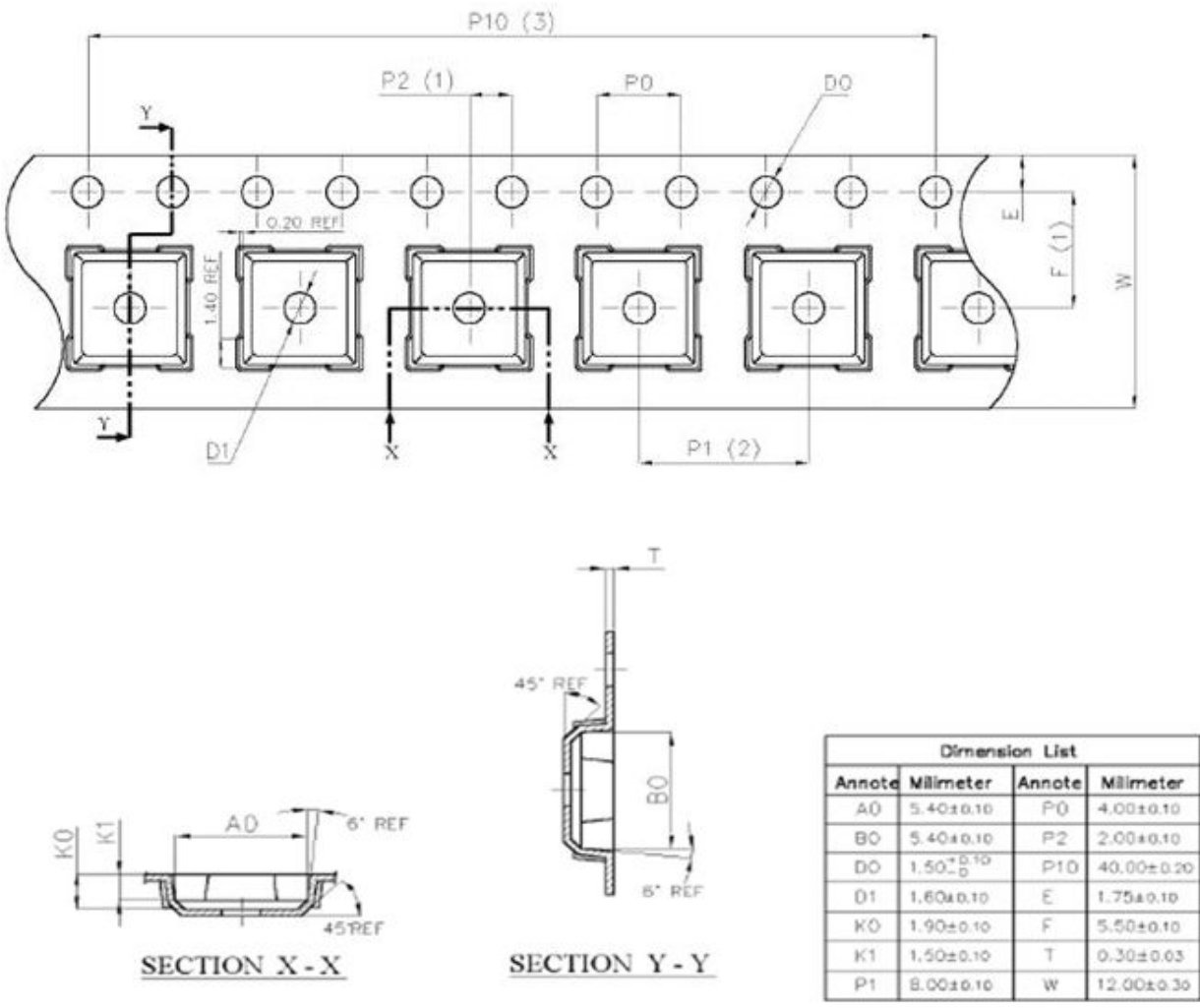

Dimension List			
Annote	Millimeter	Annote	Millimeter
A0	5.40±0.10	P0	4.00±0.10
B0	5.40±0.10	P2	2.00±0.10
D0	1.50 ^{+0.10} ₀	P10	40.00±0.20
D1	1.60±0.10	E	1.75±0.10
K0	1.90±0.10	F	5.50±0.10
K1	1.50±0.10	T	0.30±0.03
P1	8.00±0.10	W	12.00±0.30

Reel Dimensions (7" reel)

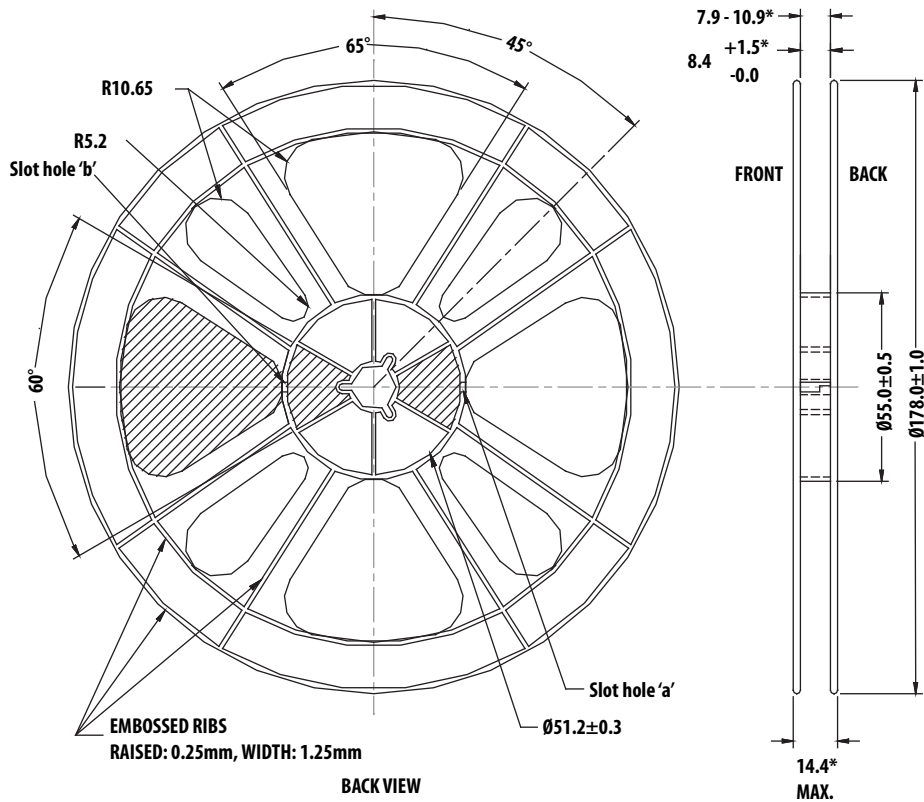
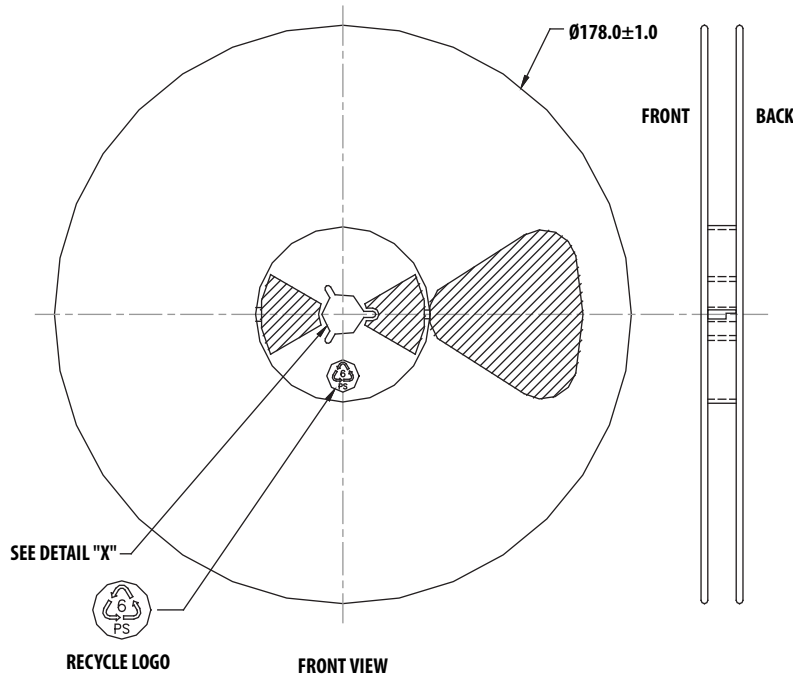

For product information and a complete list of distributors, please go to our web site: www.avagotech.com

Avago, Avago Technologies, and the A logo are trademarks of Avago Technologies in the United States and other countries. Data subject to change. Copyright © 2005-2012 Avago Technologies. All rights reserved. AV02-3796EN - October 30, 2012

