

PLEASE CHECK WWW.MOLEX.COM FOR LATEST PART INFORMATION

Part Number: [0250011002](#)
Status: **Active**
Overview: ribbon_cable_jumpers
Description: 2.54mm (.100") Pitch Board-to-Board Ribbon Cable Jumper - 26 AWG, Stranded Topcoat, 10 Circuits, Strip and Retain, 0.051m (2.00") Length

Documents:

[Drawing \(PDF\)](#) [RoHS Certificate of Compliance \(PDF\)](#)

General

Product Family	Cable
Series	25001
Crimp Quality Equipment	Yes
Geographic Area	Asia
Overview	ribbon_cable_jumpers
Product Name	Ribbon

Physical

Cable Length	0.051m (2.00")
Circuits (Loaded)	10
Circuits (maximum)	10
Insulation	PVC
Packaging Type	Bag
Pitch - Term. Interface (in)	0.100 In
Pitch - Term. Interface (mm)	2.54 mm
Temperature Range - Operating	-20°C to +105°C
Wire Size AWG	26
Wire/Cable Type	(7x34) Stranded, Topcoat

Electrical

Current - Maximum per Contact	N/A
Voltage - Maximum	300V

Material Info

Reference - Drawing Numbers

Sales Drawing	SD-25001-001
---------------	--------------



EU RoHS

**ELV and RoHS
Compliant**
**REACH SVHC
Not Reviewed**
**Halogen-Free
Status
Not Reviewed**

China RoHS



**Need more information on product
environmental compliance?**

Email productcompliance@molex.com
 For a multiple part number RoHS Certificate of Compliance, [click here](#)

Please visit the [Contact Us](#) section for any non-product compliance questions.

Search Parts in this Series
[25001Series](#)

CABLE SPECIFICATIONS:

1.- STANDARD JUMPER SERIES # 25001 (8996 CABLE .125" S/R BOTH ENDS)

2.- PHYSICAL

CONDUCTOR SPACING ----- .100" (2.54mm) ϕ TO ϕ
 WIRE GAUGE ----- 26 AWG (7/34), STRANDED, TOPCOAT
 INSULATION ----- GRAY PVC
 EDGE MARK COLOR ----- RED

3.- AGENCY

U.L. STYLE ----- 2651
 TEMPERATURE RATING ----- -20 °C TO 105 °C
 VOLTAGE RATING ----- 300V. MAX.
 FLAMMABILITY RATING ----- VW-1

4.- SPECIAL REQUIREMENT

RoHS AND LEAD FREE COMPLIANT
 NO TEXT MARKING ON PCB

5.- GENERAL

NON-OPERATING TEMPERATURE ----- -20°C TO 105°C $\triangle B_1$

6.- SOLDERING CONDITION

SOLDER TEMPERATURE ----- 260°C. MAX.
 SOLDERING TIME ----- 3 SECOND. MAX.
 INSULATION SHRINK ----- 2MM. NOM

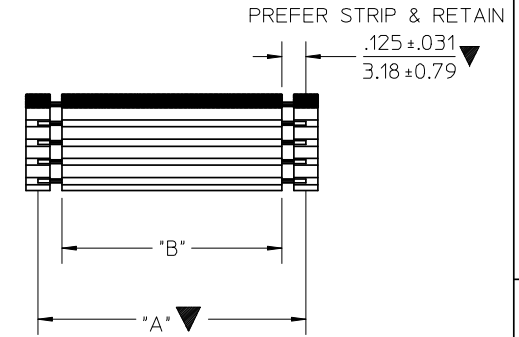

PCB HOLE LAYOUT
 RECOMENDED HOLE DIA. .032 In.



OVERALL LENGTH ("A")
 TOLERANCE FOR OAL +/- .100"
 INSULATION LENGTH ("B" REF.)
 DIMS "A" & "B" REFERS TO
 SHOWN IN MATRIX.

MATRIX FOR STANDARD JUMPERS SERIES # 25001 (8996 CABLE .125" S/R BOTH ENDS)

LENGTH "A" (±.100")	1.250"	2.250"	3.250"	4.250"	5.250"	6.250"	7.250"	8.250"
LENGTH "B" CIRCUITS (REF)	1.000"	2.000"	3.000"	4.000"	5.000"	6.000"	7.000"	8.000"
3	25001-0301	25001-0302	25001-0303	25001-0304	25001-0305	25001-0306	25001-0307	25001-0308
4	25001-0401	25001-0402	25001-0403	25001-0404	25001-0405	25001-0406	25001-0407	25001-0408
5	25001-0501	25001-0502	25001-0503	25001-0504	25001-0505	25001-0506	25001-0507	25001-0508
6	25001-0601	25001-0602	25001-0603	25001-0604	25001-0605	25001-0606	25001-0607	25001-0608
7	25001-0701	25001-0702	25001-0703	25001-0704	25001-0705	25001-0706	25001-0707	25001-0708
8	25001-0801	25001-0802	25001-0803	25001-0804	25001-0805	25001-0806	25001-0807	25001-0808
9	25001-0901	25001-0902	25001-0903	25001-0904	25001-0905	25001-0906	25001-0907	25001-0908
10	25001-1001	25001-1002	25001-1003	25001-1004	25001-1005	25001-1006	25001-1007	25001-1008
11	25001-1101	25001-1102	---	---	---	---	---	---

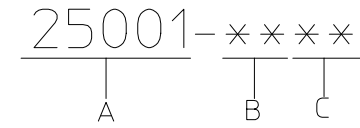

A = STD. JUMPER I.D. No
 B = CIRCUIT SIZE
 3 THRU 11
 C = DENOTES LENGTH
 1.000" TO 8.000"

SEE CHANGE DETAIL EC NO: THL2008-0019 DRWN: CPANSAKHOH 2007/12/07 CHKD: NCHALERM 2007/12/11 APPR: SVIRATJAPOL 2007/12/20	QUALITY SYMBOLS $\nabla=3$ $\nabla=0$	GENERAL TOLERANCES (UNLESS SPECIFIED)		DIMENSION STYLE IN/MM		SCALE NTS	DESIGN UNITS INCH	THIRD ANGLE PROJECTION			
		4 PLACES \pm --- \pm ---	mm INCH	DRAWN BY PREECHAI	DATE 2006/05/17	TITLE STANDARD JUMPER .100" CTR PVC INSULATED 26 AWG STR. TOPCATED					
		3 PLACES \pm --- \pm ---	2 PLACES \pm --- \pm ---	CHECKED BY DNARINTARA	DATE 2006/05/17	MOLEX INCORPORATED					
		1 PLACE \pm --- \pm ---	ANGULAR \pm --- °	APPROVED BY SVIRATJAPOL	DATE 2006/05/17	MATERIAL NO. SEE CHART	DOCUMENT NO. SD-25001-001	SHEET NO. 1 OF 1			
DRAFT WHERE APPLICABLE MUST REMAIN WITHIN DIMENSIONS		THIS DRAWING CONTAINS INFORMATION THAT IS PROPRIETARY TO MOLEX INCORPORATED AND SHOULD NOT BE USED WITHOUT WRITTEN PERMISSION									