

Installation Instructions for the TruStability[®] HSC Series and SSC Series Board Mount Pressure Sensors, Analog Output

ISSUE 5
50044172

GENERAL INFORMATION

TruStability™ High Accuracy Silicon Ceramic (HSC) Series and Standard Accuracy Silicon Ceramic (SSC) Series sensors are piezoresistive silicon pressure sensors offering a ratiometric analog output for reading pressure over the specified full scale pressure span and temperature range. They are available in standard pressure ranges from 1 psi to 150 psi (60 mbar to 10 bar) and are intended for use with non-corrosive, non-ionic gases, such as air and other dry gases. The liquid media option extends the performance of these sensors to non-corrosive, non-ionic liquids.

LIQUID MEDIA OPTION

CAUTION

PRODUCT DAMAGE

- Ensure liquid media is applied to Port 1 only; Port 2 is not compatible with liquids.
- Ensure liquid media contains no particulates. All TruStability[®] sensors are dead-ended devices. Particulates can accumulate inside the sensor, causing damage or affecting sensor output.
- Recommend that the sensor be positioned with Port 1 facing downwards; any particulates in the system are less likely to enter and settle within the pressure sensor if it is in this position.
- Ensure liquid media does not create a residue when dried; build-up inside the sensor may affect sensor output. Rinsing of a dead-ended sensor is difficult and has limited effectiveness for removing residue.
- Ensure liquid media are compatible with wetted materials. Non-compatible liquid media will degrade sensor performance and may lead to sensor failure.

Failure to comply with these instructions may result in product damage.

SOLDERING

See soldering times and temperatures in Table 2.

CLEANING

CAUTION

IMPROPER CLEANING

- Ensure cleaning fluids, such as appropriate alcohols or fluorinated solvents, are used based on the type of contaminants to be removed.
- Do not immerse the sensor.

Failure to comply with these instructions may result in product damage.

Table 1. Environmental Specifications

Parameter	Characteristic
Humidity:	
Dry gases only	0% to 95% RH, non-condensing
Liquid media option	100% condensing or direct liquid media on Port 1
Vibration	MIL-STD-202F, Curve AK (20.7 g random)
Shock	MIL-STD-202F, Method 213B, Condition F
Life ¹	1 million cycles minimum
Solder reflow	J-STD-020-C

Table 2. Absolute Maximum Ratings²

Parameter	Min.	Max.	Unit
Supply voltage	-0.3	6.0	V
Voltage on output pin	-0.3	V _{supply} + 0.3	V
ESD susceptibility (human body model)	3	-	kV
Storage temperature range	-40 [-40]	85 [185]	°C [°F]
Soldering times and temperature:			
Lead solder (SIP, DIP)		4 s max. at 250 °C [482 °F]	
Peak reflow (SMT)		15 s max. at 250 °C [482 °F]	

TruStability[®] HSC Series and SSC Series, Analog Output

Issue 5 50044172

Table 3. Operating Specifications

Parameter	Min.	Typ.	Max.	Unit
Supply voltage (V _{supply}) ³ :				Vdc
3.3 V	3.0	3.3 ⁴	3.6	
5.0 V	4.75	5.0 ⁴	5.25	
Supply current:				mA
3.3 V supply	-	1.6	2.1	
5.0 V supply	-	2	3	
Compensated temperature range ⁵ :				°C [°F]
HSC Series	0 [32]	-	50 [122]	
SSC Series	-20 [-4]	-	85 [185]	
Operating temperature range ⁶ :				°C [°F]
HSC Series	-20 [-4]	-	85 [185]	
SSC Series	-40 [-40]	-	85 [185]	
Startup time (power up to data ready)	-	-	5	ms
Response time	-	1	-	ms
Upper output clipping limit	-	-	97.5	%V _{supply}
Lower output clipping limit	2.5	-	-	%V _{supply}
Accuracy ⁷	-	-	±0.25	%FSS BFSL
Total error band ⁸ :				%FSS ⁹
HSC Series	-	-	±1	
SSC Series	-	-	±2	
Output resolution	0.03	-	-	%FSS ⁹

Table 4. Wetted Materials¹⁰

Parameter	Port 1 (Pressure Port)	Port 2 (Reference Port)
Covers	high temperature polyamide	high temperature polyamide
Substrate	alumina ceramic	alumina ceramic
Adhesives	epoxy, silicone	epoxy, silicone
Electronic components	ceramic, glass, solder, silicon	silicon, glass, gold, solder

Notes:

- Life may vary depending on specific application in which sensor is utilized.
- Absolute maximum ratings are the extreme limits the device will withstand without damage.
- Ratiometricity of the sensor (the ability of the device to scale to the supply voltage) is achieved within the specified operating voltage for each option. Other custom supply voltages are available, please contact Honeywell Customer Service.
- The sensor is not reverse polarity protected. Incorrect application of supply voltage or ground to the wrong pin may cause electrical failure.
- The compensated temperature range is the temperature range over which the sensor will produce an output proportional to pressure within the specified performance limits.
- The operating temperature range is the temperature range over which the sensor will produce an output proportional to pressure but may not remain within the specified performance limits.
- Accuracy: The maximum deviation in output from a Best Fit Straight Line (BFSL) fitted to the output measured over the pressure range at 25 °C [77 °F]. Includes all errors due to pressure non-linearity, pressure hysteresis, and non-repeatability.
- Total Error Band: The maximum deviation from the ideal transfer function over the entire compensated temperature and pressure range. Includes all errors due to offset, full scale span, pressure non-linearity, pressure hysteresis, repeatability, thermal effect on offset, thermal effect on span, and thermal hysteresis.
- Full Scale Span (FSS) is the algebraic difference between the output signal measured at the maximum (P_{max.}) and minimum (P_{min.}) limits of the pressure range.
- Contact Honeywell Customer Service for detailed material information.

Table 5. Pinout for DIP and SMT Packages

Output Type	Pin 1	Pin 2	Pin 3	Pin 4	Pin 5	Pin 6	Pin 7	Pin 8
analog	NC	V _{supply}	OUTPUT+	GND	NC	NC	NC	NC

Table 6. Pinout for SIP Package

Output Type	Pin 1	Pin 2	Pin 3	Pin 4
analog	NC	V _{supply}	OUTPUT+	GND

TruStability[®] HSC Series and SSC Series, Analog Output

Issue 5 50044172

Figure 1. DIP Pressure Port Dimensional Drawings (For reference only: mm [in])

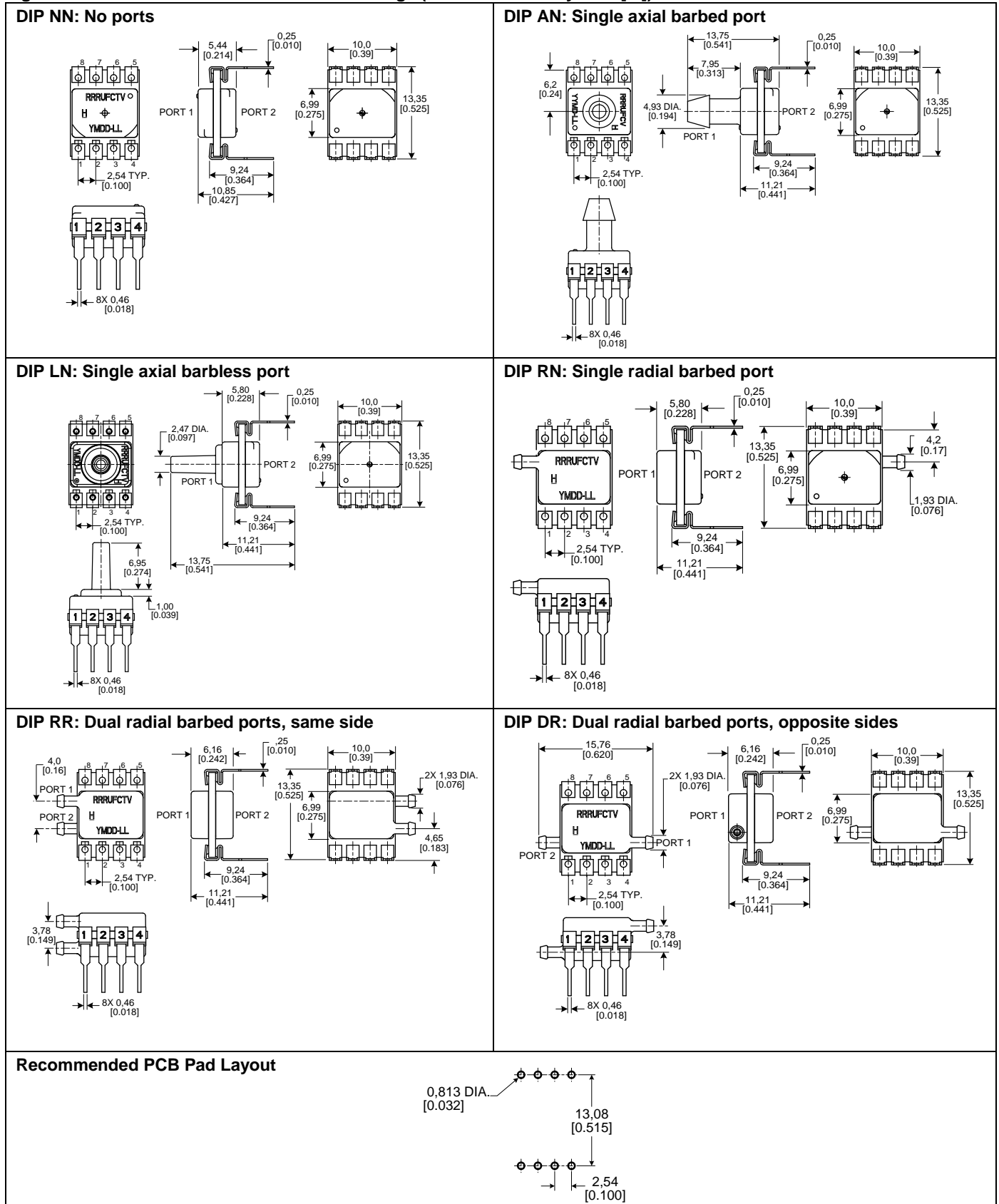

TruStability[®] HSC Series and SSC Series, Analog Output

Issue 5 50044172

Figure 2. SMT Pressure Port Dimensional Drawings (For reference only: mm [in])

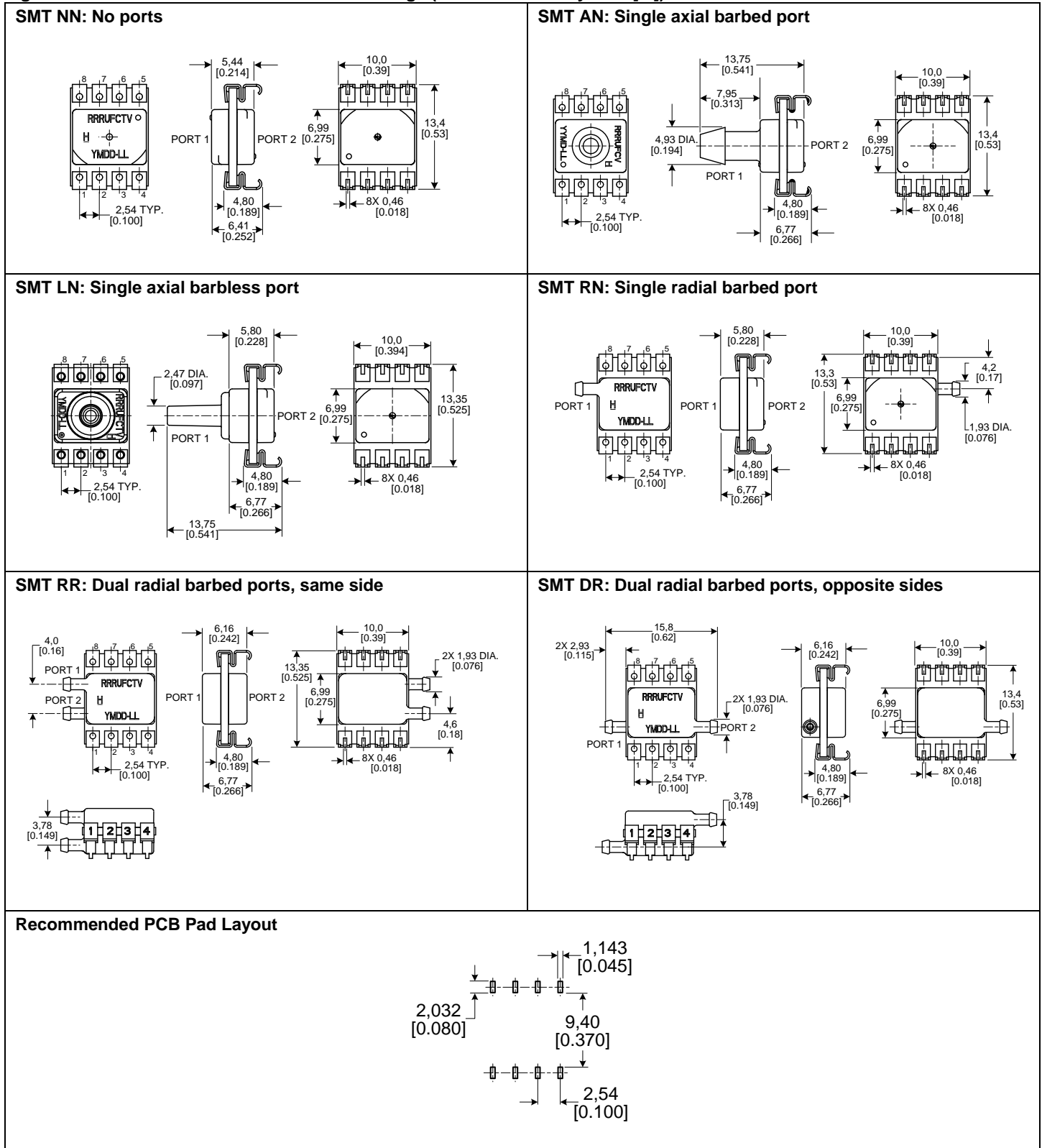

TruStability[®] HSC Series and SSC Series, Analog Output

Issue 5 50044172

Figure 3. SIP Package Dimensional Drawings (For reference only: mm [in])

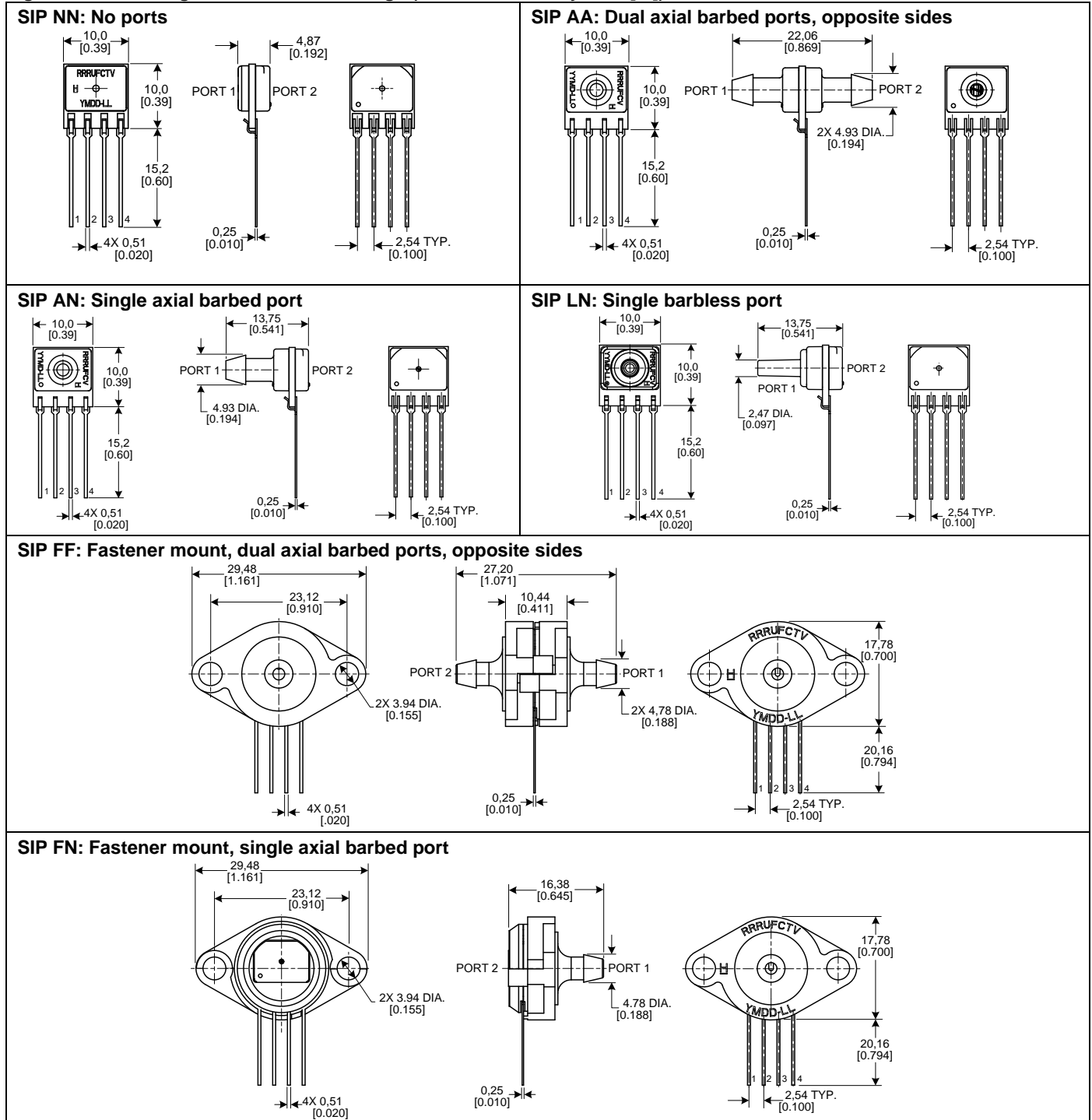
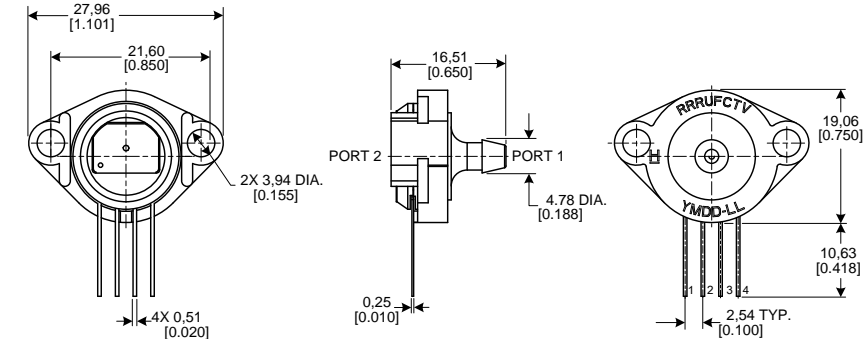
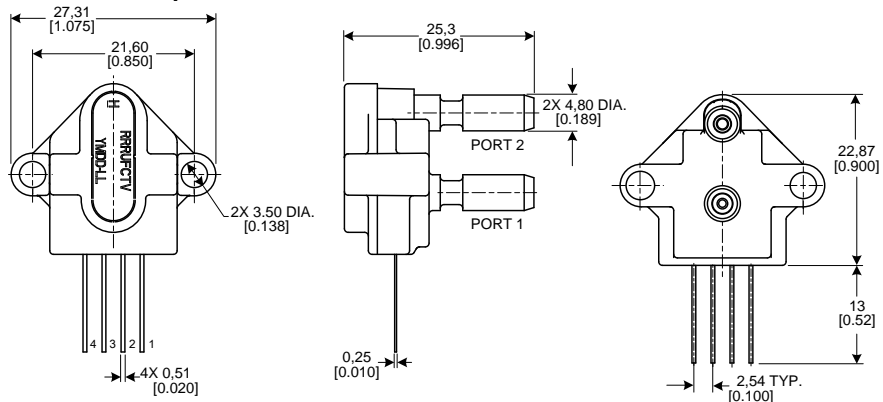

Figure 3. SIP Package Dimensional Drawings (continued)

SIP GN: Ribbed fastener mount, single axial barbed port



SIP NB: Fastener mount, dual axial ports, same side



SIP RN: Single radial barbed port

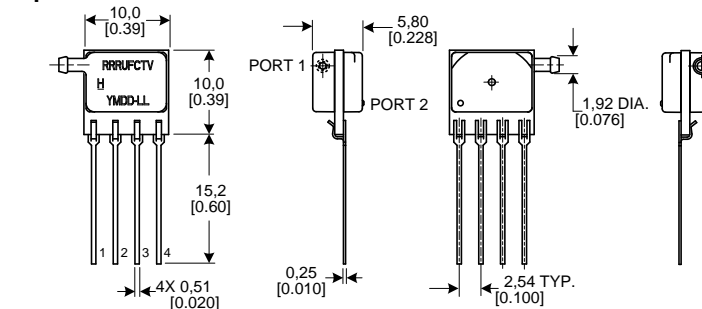

SIP RR: Dual radial barbed ports, same side

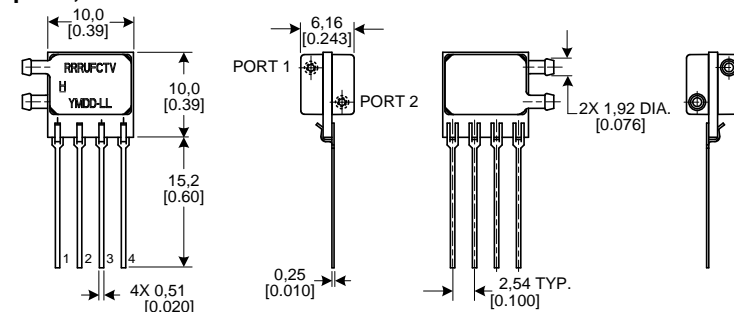

TruStability[®] HSC Series and SSC Series, Analog Output

Issue 5 50044172

Figure 3. SIP Package Dimensional Drawings (continued)

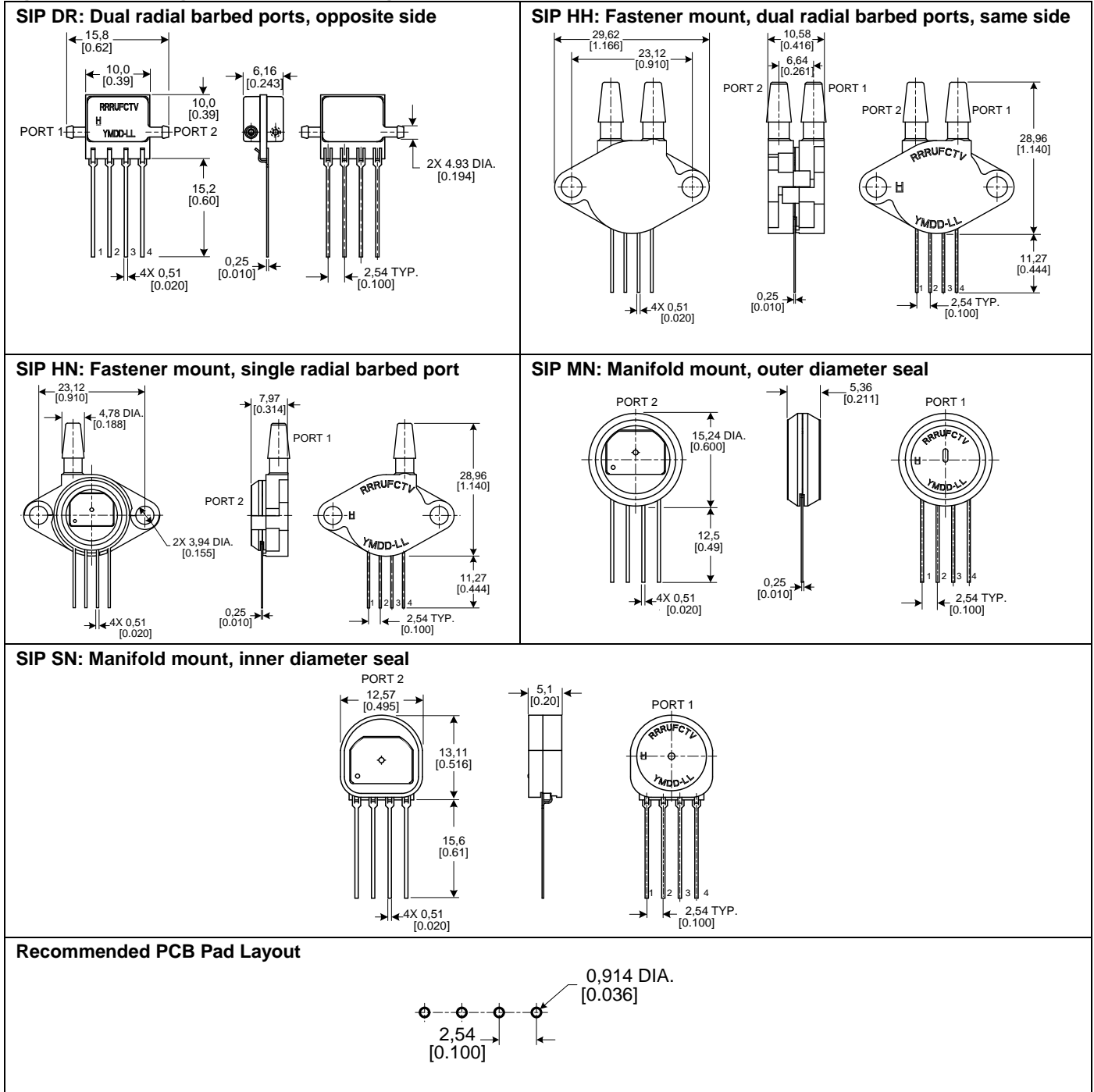

TruStability[®] HSC Series and SSC Series, Analog Output

Issue 5 50044172

WARNING

PERSONAL INJURY

- DO NOT USE these products as safety or emergency stop devices or in any other application where failure of the product could result in personal injury.

Failure to comply with these instructions could result in death or serious injury.

WARRANTY/REMEDY

Honeywell warrants goods of its manufacture as being free of defective materials and faulty workmanship. Honeywell's standard product warranty applies unless agreed to otherwise by Honeywell in writing; please refer to your order acknowledgement or consult your local sales office for specific warranty details. If warranted goods are returned to Honeywell during the period of coverage, Honeywell will repair or replace, at its option, without charge those items it finds defective. **The foregoing is buyer's sole remedy and is in lieu of all other warranties, expressed or implied, including those of merchantability and fitness for a particular purpose. In no event shall Honeywell be liable for consequential, special, or indirect damages.**

While we provide application assistance personally, through our literature and the Honeywell web site, it is up to the customer to determine the suitability of the product in the application.

Specifications may change without notice. The information we supply is believed to be accurate and reliable as of this printing. However, we assume no responsibility for its use.

SALES AND SERVICE

Honeywell serves its customers through a worldwide network of sales offices, representatives and distributors. For application assistance, current specifications, pricing or name of the nearest Authorized Distributor, contact your local sales office or:

E-mail: info.sc@honeywell.com

Internet: <http://sensing.honeywell.com>

Phone and Fax:

Asia Pacific	+65 6355-2828 +65 6445-3033 Fax
Europe	+44 (0) 1698 481481 +44 (0) 1698 481676 Fax
Latin America	+1-305-805-8188 +1-305-883-8257 Fax
USA/Canada	+1-800-537-6945 +1-815-235-6847 +1-815-235-6545 Fax

Sensing and Control
Honeywell
1985 Douglas Drive North
Golden Valley, MN 55422
<http://sensing.honeywell.com>

50044172-5-EN
August 2012
Copyright © 2012 Honeywell International Inc. All rights reserved.

Honeywell