



Search by Part #



LEDtronics SEARCH

- HOME

HOME

- CONTACT US

CONTACT US

- ABOUT US

ABOUT US

- PRODUCTS

PRODUCTS

- TOOLS

TOOLS

- QUOTES

QUOTES

- MARKETS/APPLICATION

MARKETS/APPLICATION

- MEDIA

MEDIA

- TECH NOTES

TECH NOTES

[Sign In.](#) [New User?](#) [Sign Up.](#)

LEDs, PC Board, T1 (3mm) Right-Angled Quad-Level

Direct Cross To Dialight 568, CM/IDI 5694F, Kingbright L934, Lumex SSF-LXH475

Hi-Efficiency or Sunlight-Visible; Diffused or Clear

Low Cost L-41PCT170

Shopping Cart



[View Cart](#)



[Check Out](#)

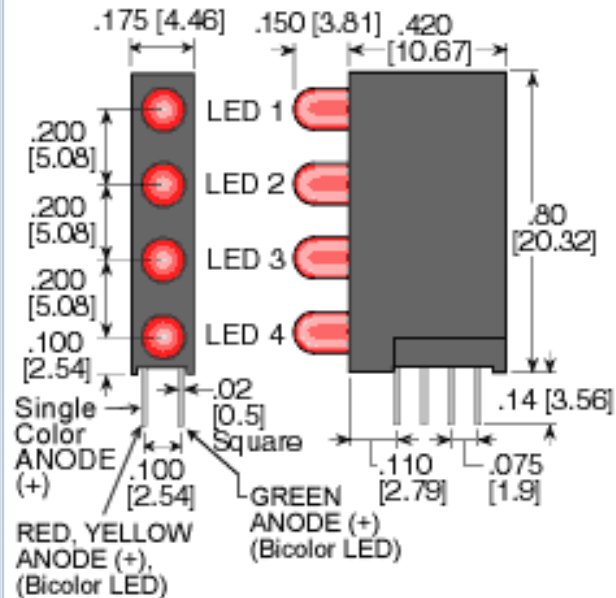

Options

Contact Us

Email This Page

[Click to buy from our DISTRIBUTORS](#)



All Series under this Category:

41PCT170 Four-Level, One Column Array; 4.46mm wide segments; Same Color or Mix; 45° Beam

41PCT170T_LC Four-Level, One Column Array; 4.46mm wide segments; 2mA Low-Current; 45° Beam

41PCT170T_B Four-Level, One Column Array; 4.46mm wide segments; Bicolor 50° Beam



41PCT130T Series Quad-Level, Right-Angled PCB LEDs

T1 (3mm) Quad-Level, Same Color, High-Efficiency (Diffused) LEDs



Same Color

Electrical-Optical Characteristics (Ta = 25°C)

| CLICK TO ORDER | PART NO. (DESCRIPTION) | PRICE | MIN BUY | I _f , mA (typ) | V _f , V (typ)/(max) | I _v , mcd (typ) | LED Emitting Color | Full Viewing Angle (2θ _{1/2}) |
|----------------|---------------------------------|----------|---------|------------------------------|-----------------------------------|-------------------------------|--|--|
| | 41PCT170TR6 (RoHSVC122806) | \$1.44ea | 250 | 20 | 1.7/2.6 | 150 |  Ultra Red | 45° |
| | 41PCT170TR4 (RoHS) | \$1.44ea | 250 | 20 | 2.0/2.8 | 30 |  Hi-Eff Red | 45° |
| | 41PCT170TO4 (RoHSVC122106) | \$1.44ea | 250 | 20 | 2.1/2.8 | 14 |  Orange | 45° |
| | 41PCT170TY4 (RoHSVC122106) | \$1.44ea | 250 | 20 | 2.1/2.8 | 24 |  Yellow | 45° |
| | 41PCT170TG4 (RoHS062906) | \$1.44ea | 250 | 20 | 2.1/2.8 | 12 |  Hi-Eff Green | 45° |
| | 41PCT170TUB5 (RoHSVC102006) | \$3.20ea | 100 | 20 | 3.8/5.0 | 30 |  Ultra Blue | 45° |

Mixed LEDs in a Quad-Level. High-Efficiency (Diffused) LEDs











(41PCT170T4-0010)

(Sample with Blank Space, description 41PCT170T4-G/x/G/Y, custom order)



Electrical-Optical Characteristics (Ta = 25°C)

| CLICK TO ORDER | PART NO. (DESCRIPTION) | PRICE | MIN BUY | | | | | | |
|----------------|--|----------|------------|--|--|---------|----|--|-----|
| | <p>41PCT170T4-0010 (41PCT170T4-Y/G/Y/G RoHSVC011007)</p>  <p>LEDS Top to Bottom: Yellow/Green/Yellow/Green</p> | \$1.44ea | 250 | <p>I_f, mA V_f, V I_v, mcd LED Emitting Full Viewing</p> <p>(typ) (typ)/(max) (typ) Color Angle (2θ_{1/2})</p> | 20 | 2.1/2.8 | 24 |  Yellow | 45° |
| 20 | 2.1/2.8 | | | 12 |  Hi-Eff Green | 45° | | | |
| | | | | | | | | | |
| | <p>41PCT170T4-0018 (41PCT170T4-R/G/G/G RoHS)</p>  <p>LEDS Top to Bottom: Red/Green/Green/Green</p> | \$1.44ea | 250 | <p>I_f, mA V_f, V I_v, mcd LED Emitting Full Viewing</p> <p>(typ) (typ)/(max) (typ) Color Angle (2θ_{1/2})</p> | 20 | 2.0/2.8 | 30 |  Hi-Eff Red | 45° |
| 20 | 2.1/2.8 | | | 12 |  Hi-Eff Green | 45° | | | |
| | | | | | | | | | |
| | <p>41PCT170T4-0028 ((41PCT170T4- X/X/Y/G)RoHSVC010207)</p>  <p>LEDS Top to Bottom: Blank/Blank/Yellow/Green</p> | \$1.44ea | 250 | <p>I_f, mA V_f, V I_v, mcd LED Emitting Full Viewing</p> <p>(typ) (typ)/(max) (typ) Color Angle (2θ_{1/2})</p> | 20 | 2.1/2.8 | 24 |  Yellow | 45° |
| 20 | 2.1/2.8 | | | 12 |  Hi-Eff Green | 45° | | | |
| | | | | | | | | | |

T1 (3mm) Quad-Level, Same or Mix Color, Sunlight-Visible Diffused or Clear LEDs available for large orders

41PCT170T_LC Series Low-Current, Quad-Level, Right-Angled PCB LEDs



T1 (3mm) Quad-Level, Same or Mix Color, 2mA Low-Current (Diffused) LEDs

Electrical-Optical Characteristics (Ta = 25°C)

| CLICK TO ORDER | PART NO. (DESCRIPTION) | PRICE | MIN BUY | I _f , mA (typ) | V _f , V (typ)/(max) | I _v , mcd (typ) | LED Emitting Color | Full Viewing Angle (2θ _{1/2}) |
|----------------|---------------------------|-------|---------|------------------------------|-----------------------------------|-------------------------------|-----------------------|--|
|----------------|---------------------------|-------|---------|------------------------------|-----------------------------------|-------------------------------|-----------------------|--|

T1 (3mm) Quad-Level, Same or Mix Color, High-Efficiency Tinted-Clear LEDs available for large orders

T1 (3mm) Quad-Level, Same or Mix Color, 5V Integrated Resistor Diffused LEDs available for large orders

T1 (3mm) Quad-Level, Same or Mix Color, High-Efficiency Water-Clear LEDs available for large orders

41PCT170T_B Series Bi-Color, with White Diffused Lenses

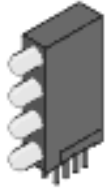

T1 (3mm) Quad-Level, Same or Mix Color, Bi-Color (Diffused) LEDs, 2-Leaded

Electrical-Optical Characteristics (Ta = 25°C)

| CLICK TO ORDER | PART NO. (DESCRIPTION) | PRICE | MIN BUY | | | | | |
|----------------|----------------------------------|----------|---------|------------------------------|-----------------------------------|--|-----------------------|--|
| | 41PCT170TWRG4B (RoHSVC102407) | \$2.16ea | 250 | I _f , mA (typ) | V _f , V (typ)/(max) | I _v , mcd (typ) | LED Emitting Color | Full Viewing Angle (2θ _{1/2}) |
| 20 | | | | 2.0/2.6 | 30 |  Hi-Eff Red | 50° | |
| 20 | | | | 2.2/2.6 | 30 |  Hi-Eff Green | 50° | |
| | 41PCT170TWYG4B (RoHS) | \$1.56ea | 250 | I _f , mA (typ) | V _f , V (typ)/(max) | I _v , mcd (typ) | LED Emitting Color | Full Viewing Angle (2θ _{1/2}) |
| 20 | | | | 2.2/2.8 | 30 |  Hi-Eff Green | 50° | |
| 20 | | | | 2.1/2.6 | 15 |  Yellow | 50° | |

All specifications and pricing subject to change without notice.

Options: For qualified applications and large quantity orders

Part Numbering Description Example: for a Mixed Color LED PCB:

Description: 41PCT170T4-G/Y/G/Y (Top Green LED #1, Yellow LED #2, Green LED #3, Bottom Yellow LED #4)

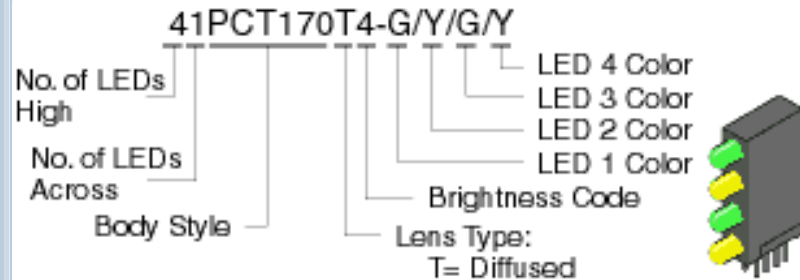

Part Numbering Description Example: 1 Blank Space:

**41PCT170T4-G/x/G/Y
(Top Green LED 1, Blank LED 2,**

Green LED 3, Bottom Yellow LED 4)



[Site Map](#) [Privacy Policy](#) [Warranty](#) [Contact Us](#) [Link Exchange](#)



23105 Kashiwa Ct, Torrance, CA 90505 - PH: (800) 579-4875/(310) 534-

1505 - FAX: (310) 534-1424



All images and pictures and text on our website is Copyrighted property of LEDtronics.
No-one is authorized to use our pictures, images, catalogs or text without our explicit written approval.
Copyright © 1997-2009 LEDtronics, Inc., All Rights Reserved.